

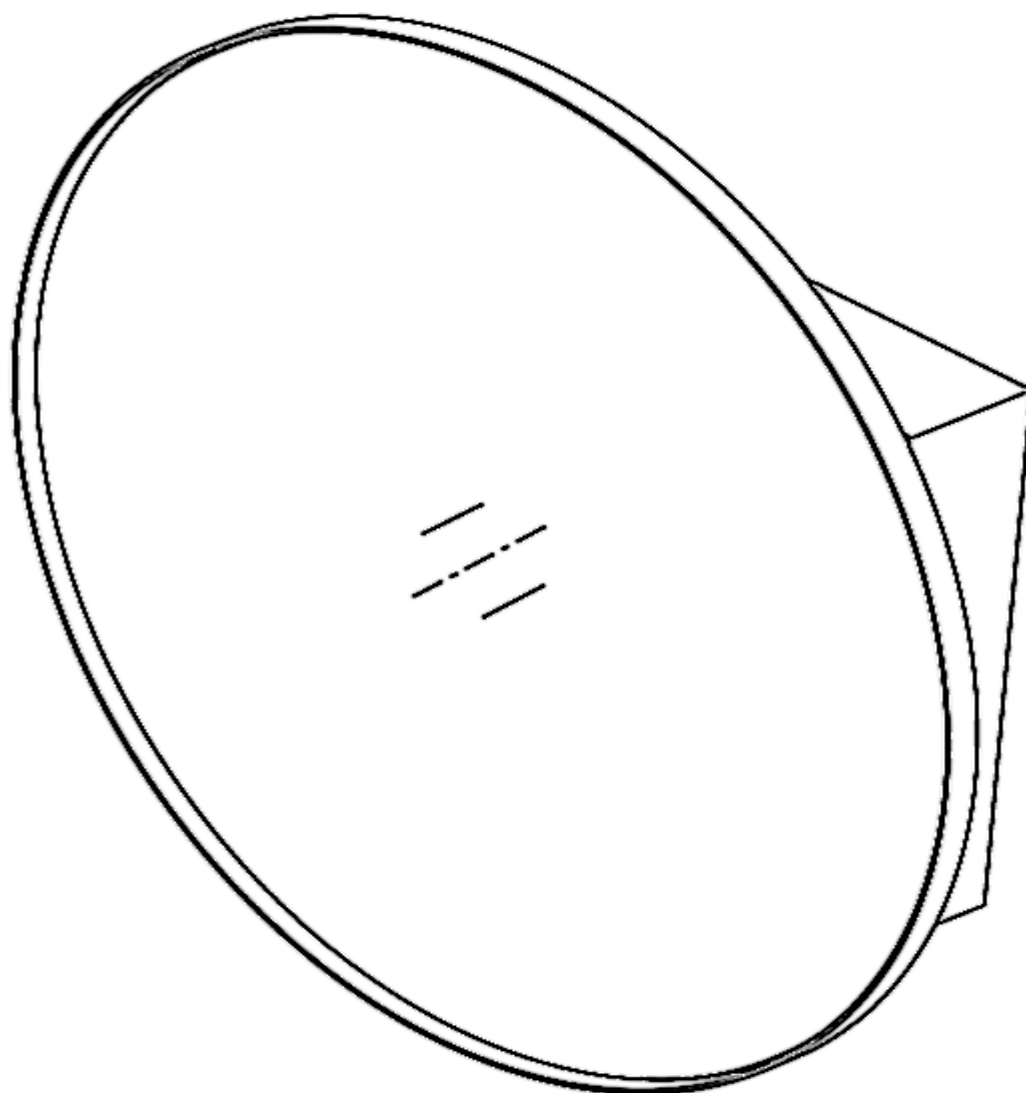

MEDICINE CABINET

Installation Guide

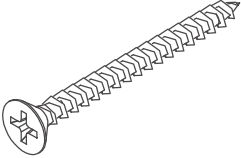
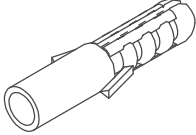
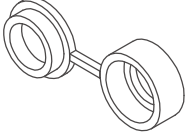

List of Parts

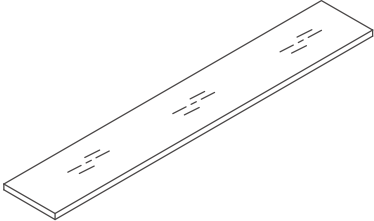
<p>A 4pcs</p>  <p>Screws</p>	<p>B 4pcs</p>  <p>Rubber plug screws</p>	<p>C 4pcs</p>  <p>Screw cover</p>
<p>D 4pcs</p>  <p>Screw washers</p>	<p>E 4pcs</p>  <p>Rubber mat</p>	<p>F 2pcs</p>  <p>Glass shelf</p>

Additional Tools Required

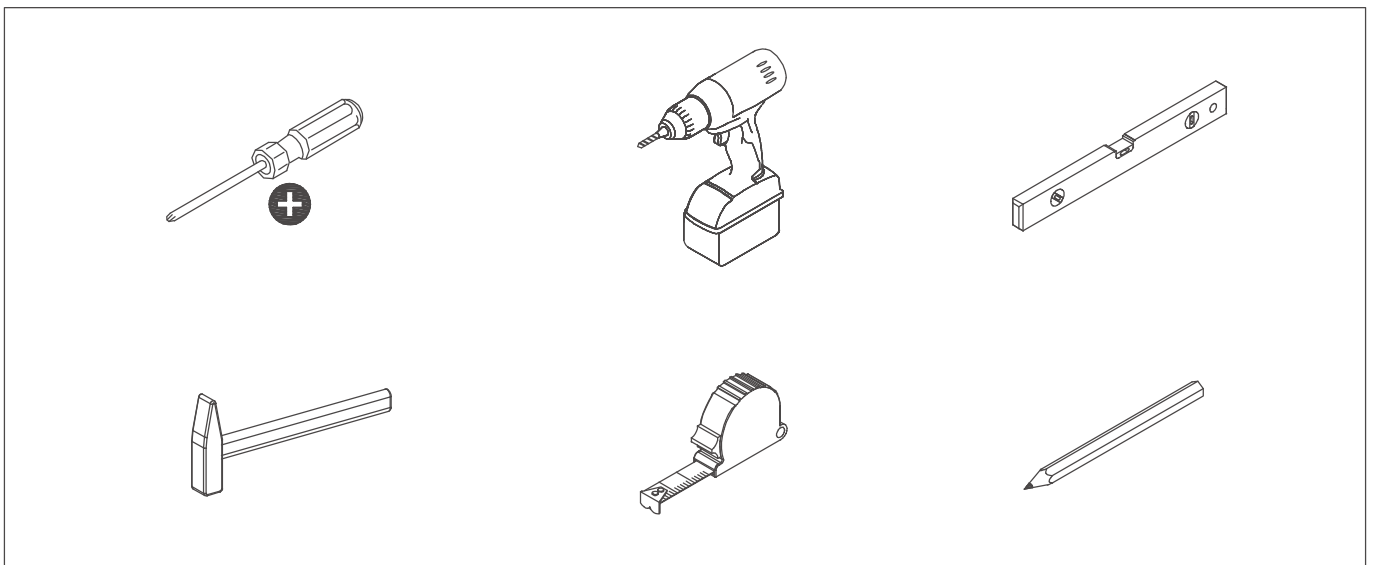

Surface installation

Mark four (4) mounting holes on the wall corresponding to the pre-drilled hole locations in the mounting bars on the inside back panel of the cabinet.

