

Bookshelf > Manual

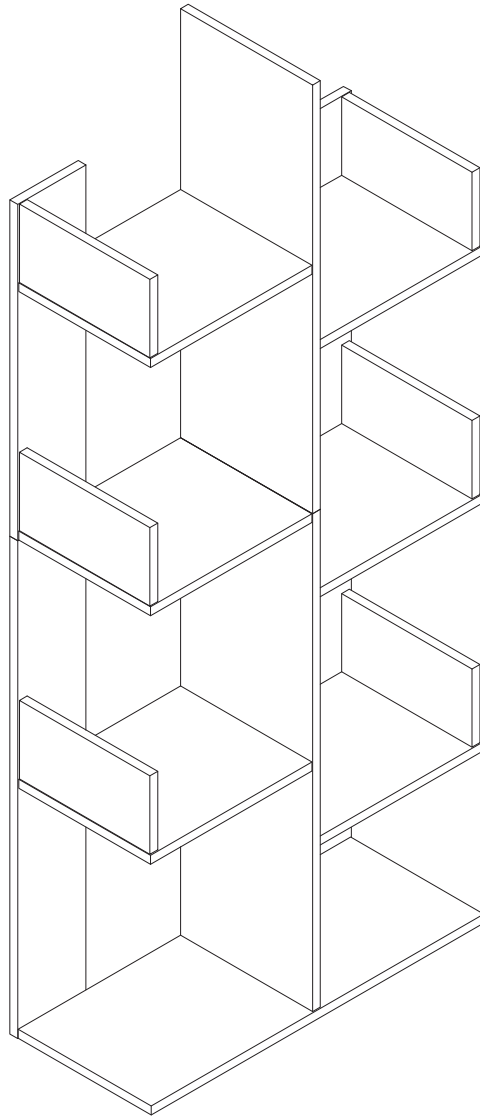

Thank you for purchase. Please contact us if you have difficulty with assembly or need replacement parts.

Please attach your User Name or Order ID so that we can assist you better.

Vielen Dank für Ihren Kauf. Bitte kontaktieren Sie uns, wenn Sie Probleme mit Montage haben oder Ersatzteile benötigen.

Bitte geben Sie Ihren Benutzernamen oder Ihre Bestellnummer an, damit wir Sie besser unterstützen können.

EN



WARNING

The product must be assembled by adult before use.

Serious or fatal injury may occur from unexpected assembly or use.

1. During the assembly process, keep all parts away from babies or children.
2. Always securely fix this product to the wall. Make sure the wall area to be drilled is free from hidden electrical wires, water and gas pipes.
3. Use of tip-over restraints may only reduce, but not eliminate the risk of tip-over.
4. Unless specially designed to accommodate, do not set heavy objects on top of this product.
5. Place the heaviest items on the lowest shelf.
6. Never allow children to climb or bang on drawers, doors or shelves.

FR

Merci pour votre achat les produits. S'il vous plaît contactez-nous si vous avez des difficultés avec assemblage ou besoin de pièces de remplacement.

Veuillez joindre votre nom d'utilisateur ou votre numéro de commande afin que nous puissions vous aider au mieux.



ATTENTION

Le produit doit être assemblé par un adulte avant utilisation.

Des blessures graves ou mortelles peuvent survenir à cause de l'assemblage ou l'utilisation inattendue.

1. Pendant le processus de montage, gardez toutes les pièces loin des bébés et des enfants.
2. Fixer toujours sécuritaire ce produit au mur. Assurez-vous que la zone du mur à percer est libre de fils électriques cachés, de conduites d'eau et de gaz.
3. L'utilisation de dispositifs de retenue pour le renversement ne peut que réduire, mais pas éliminer le risque de renversement.
4. Sauf si spécialement conçu pour accueillir, ne posez pas d'objets lourds au sommet de ce produit.
5. Placez les articles les plus lourds sur la tablette la plus basse.
6. Ne laissez jamais les enfants grimper ou cogner sur les tiroirs, les portes ou les étagères.

IT

Grazie per aver acquistato i nostri prodotti. In caso di problemi durante l'assemblaggio o la sostituzione, non esiti a contattarci. La preghiamo di allegare il Suo nome utente o l'ID dell'ordine, così saremo in grado di assisterLa al meglio.



AVVERTIMENTO

Il prodotto deve essere assemblato da un adulto prima dell'uso.

L'inaspettato montaggio potrebbe provocare i lesioni gravi o mortali.

1. Durante l'assemblaggio, metti tutti i parti fuori dalla portata dei bambini.
2. Sempre fissare saldamente questo prodotto alla parete. Assicurarsi che l'area della parete sia libera dai cavi elettrici nascosti, i tubi dell'acqua e del gas.
3. La restrizione punta-over può ridurre il rischio di punta-over ma non può eliminarlo.
4. A meno che con l'appositamente progettato, Non deporre gli oggetti pesanti sul piano superiore
5. Posiziona le robe più pesante al piano inferiore.
6. Non permettere i bambini di scalare o battere i cassetti, le porte o gli scaffali.

DE



WARNUNG

Der Produkt muss vor Gebrauch von einem Erwachsenen zusammengebaut werden.

Bei unerwarteter Montage oder Verwendung können schwere oder tödliche Verletzung auftreten.

1. Legen Sie in den Montageprozess alle Teile weg von Babys oder Kindern.
2. Befestigen Sie dieses Produkt immer sicher an der Wand. Um sicherzustellen, dass der zu bohrende Wandbereich entfernt von verdeckten Stromkabeln, Wasser- und Gasleitungen ist.
3. Die Verwendung von Kippsicherungen kann die Gefahr eines Kippens nur verringern, jedoch nicht beseitigen.
4. Setzen Sie bitte keine schweren Gegenstände auf dieses Produkt, es sei denn, dass das Produkt speziell für die Unterbringung konzipiert wird.
5. Legen Sie bitte die schwersten Gegenstände auf das unterste Regal.
6. Erlauben Sie nie Kindern, auf Schubladen, Türen oder Regale zu klettern oder zu knallen.

ES

Gracias por comprar productos. Por favor, póngase en contacto con nosotros si tiene dificultades con montaje o necesidad de repuestos.

Adjunte su nombre de usuario o ID de pedido para que podamos ayudarlo mejor.



ADVERTENCIA

El producto debe ser ensamblado por un adulto antes de su uso.

Se pueden producir lesiones graves o fatales debido al montaje o uso inesperado.

1. Durante el proceso de montaje, mantenga todas las piezas alejadas de bebés o niños.
2. Fije siempre este producto de forma segura a la pared. Asegúrese de que el área de la pared a perforar esté libre de cables eléctricos ocultos, tuberías de agua y gas.
3. El uso de restricciones de vuelco solo puede reducir, pero no elimina el riesgo de que se vuelque.
4. A menos que esté especialmente diseñado para acomodarse, no coloque objetos pesados encima de este producto.
5. Coloque los artículos más pesados en el estante más bajo.
6. Nunca permita que los niños se suban o golpeen los cajones, puertas o estantes.

CHS

ID



警告

产品必须由成人组装后才能使用。





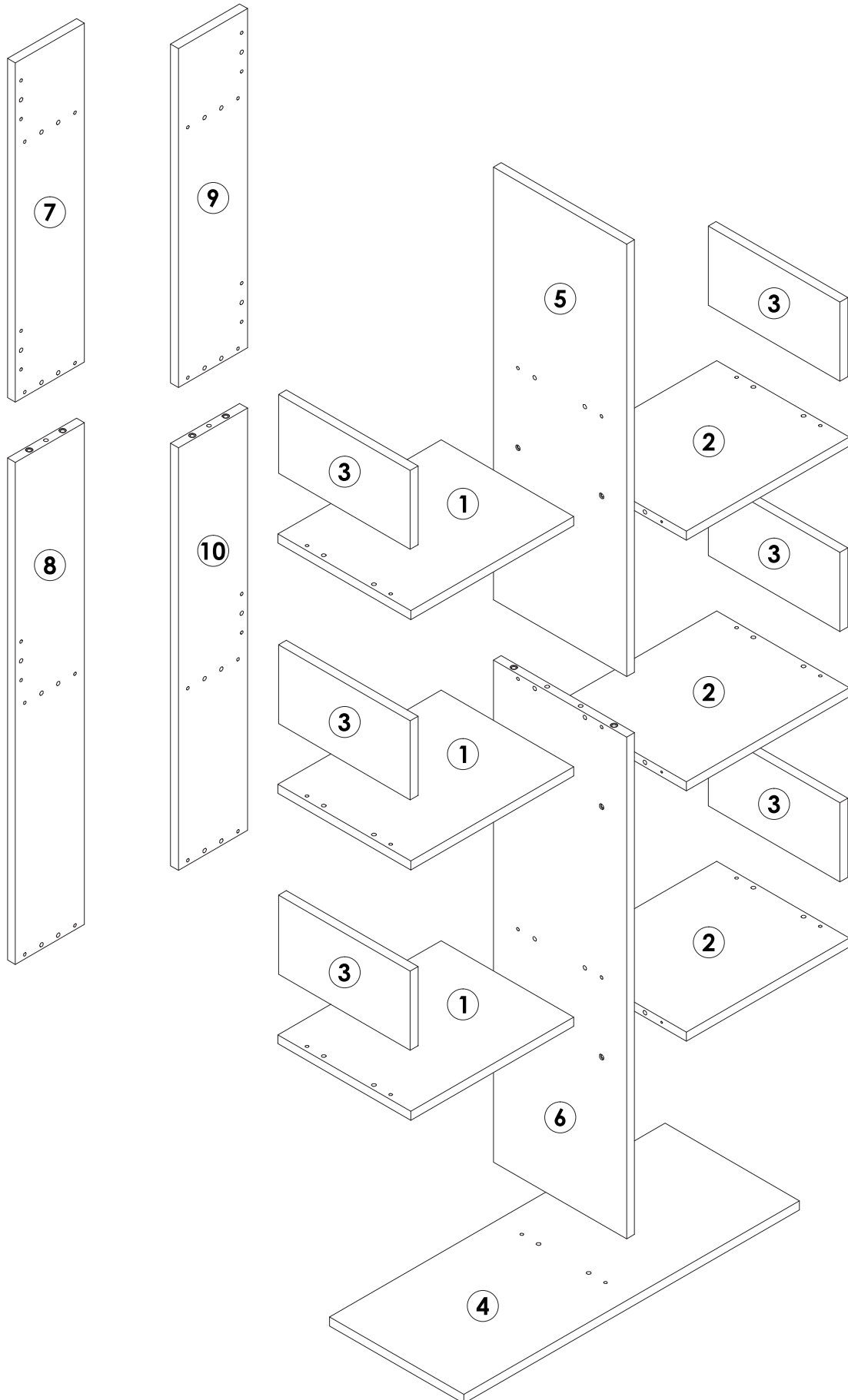

意外组装或使用可能会造成严重或致命的伤害。

1. 在组装过程中，请将所有零件远离婴幼儿。
2. 始终将本产品牢固地固定在墙上。确保钻孔的墙面远离隐蔽的电源线、水和煤气管道。
3. 使用防倾倒装置只能降低倾倒的风险，但不能消除它们。
4. 除非经过特殊设计确保可行，否则请勿在本产品上放置重物。
5. 最重的物品请放在最底层的架子上。
6. 切勿让儿童攀爬或撞击抽屉，门或架子。

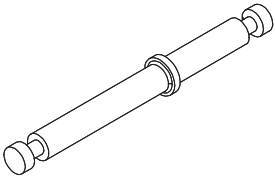
Parts List(EN) / Teile Liste(DE)

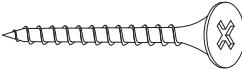

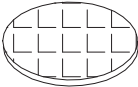
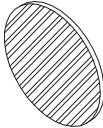
Parts List(EN) / Teile Liste(DE)

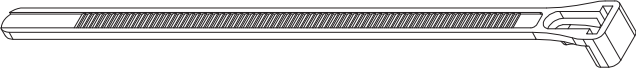
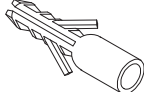
<p>A</p>  <p>M6x67mm 6PCS</p>	<p>B</p>  <p>Ø15x9mm 12+1PCS</p>	<p>C</p>  <p>M4x40mm 56+2PCS</p>	<p>D</p>  <p>Ø6x30mm 48+2PCS</p>
<p>E</p>  <p>Ø8x50mm 4PCS</p>	<p>F</p>  <p>Ø20mm 6PCS</p>	<p>G</p>  <p>Ø20mm 52+2PC</p>	<p>H</p>  <p>M3x14mm 2PCS</p>
<p>I</p>  <p>4PCS</p>	<p>J</p>  <p>2PCS</p>		<p>K</p>  <p>M6x30mm 2PCS</p>

Assembly Steps(EN) / Montageschritte(DE)

STEP 1

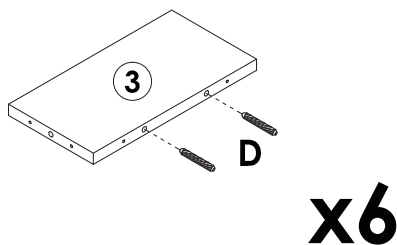
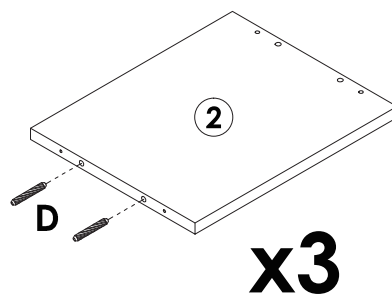
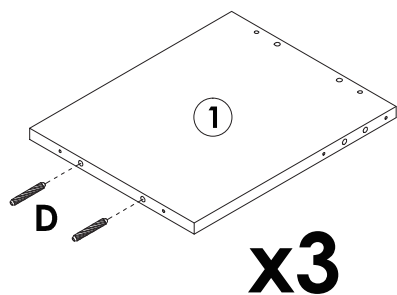

D x 24PCS

STEP 2

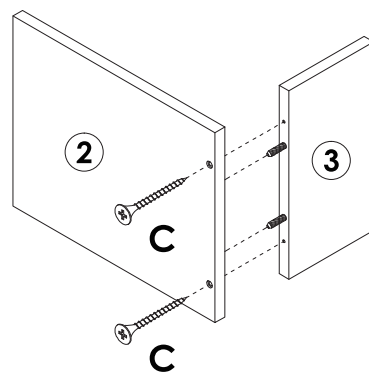
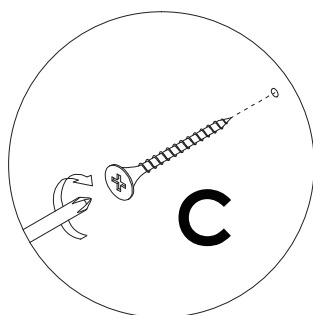
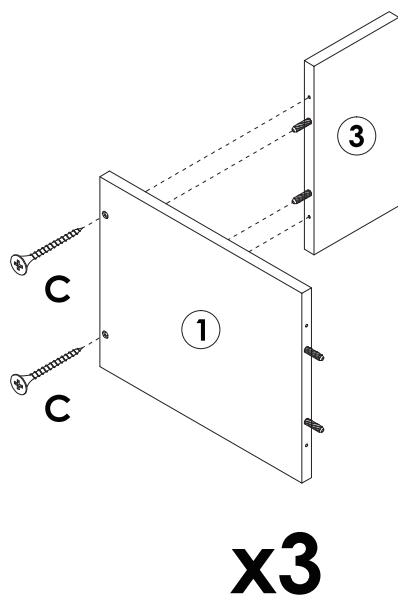



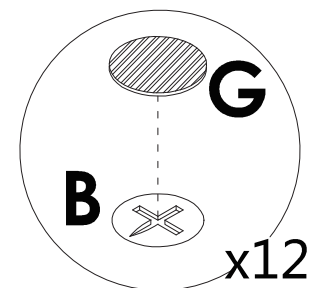
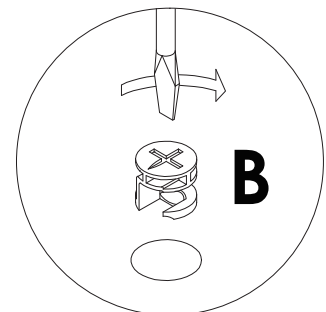
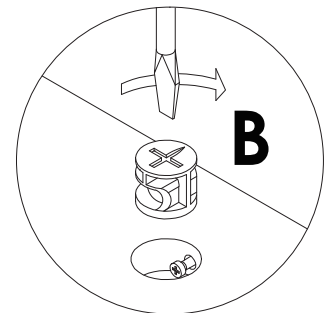
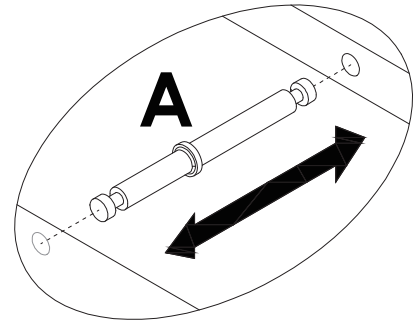
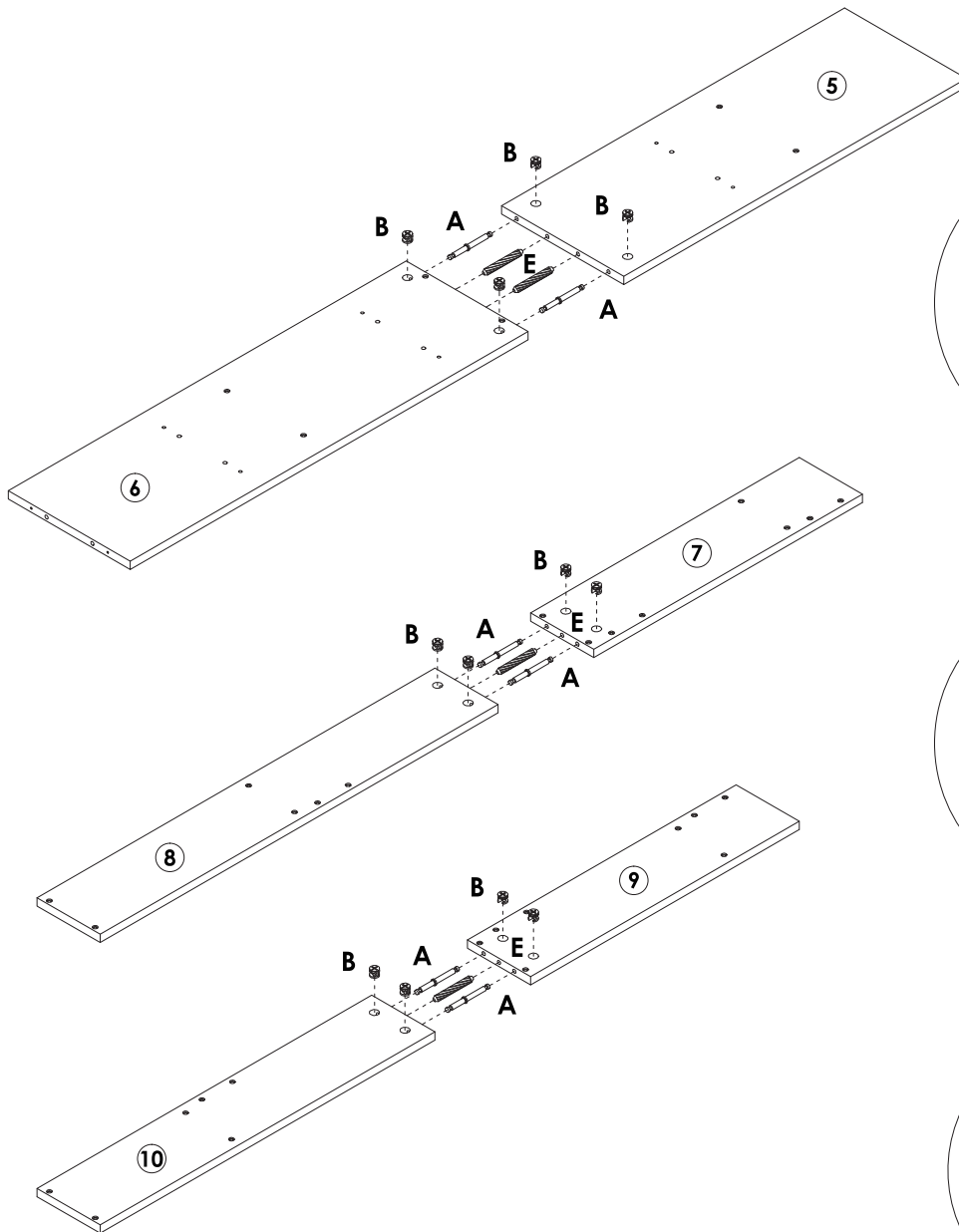

C x 12PCS

Assembly Steps(EN) / Montageschritte(DE)

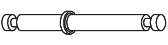
STEP 3



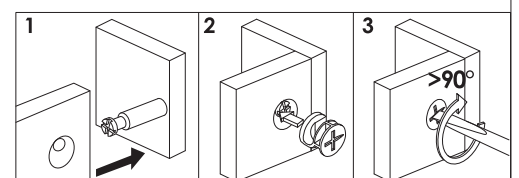

	A x 6PCS
	B x 12PCS
	E x 4PCS
	G x 12PCS



Assembly Steps(EN) / Montageschritte(DE)

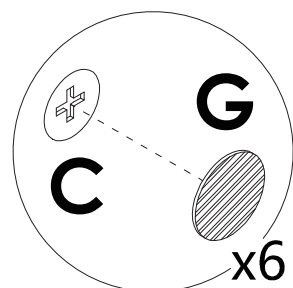
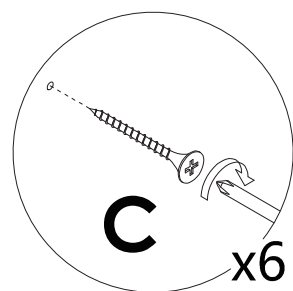
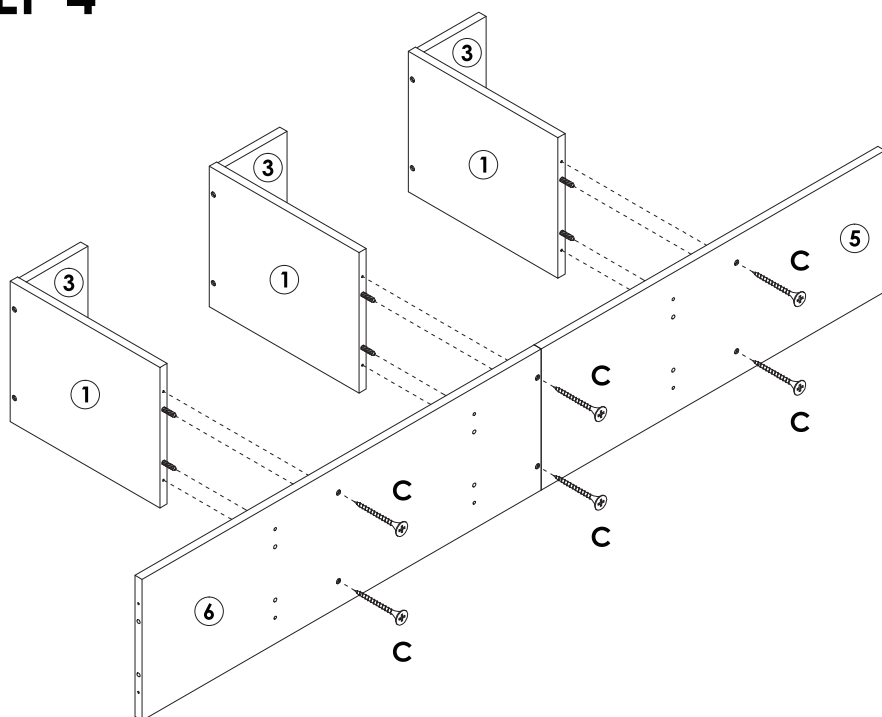

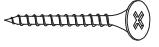
STEP 4

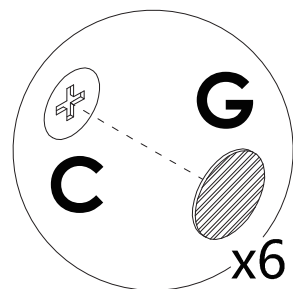
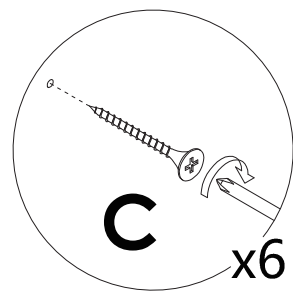
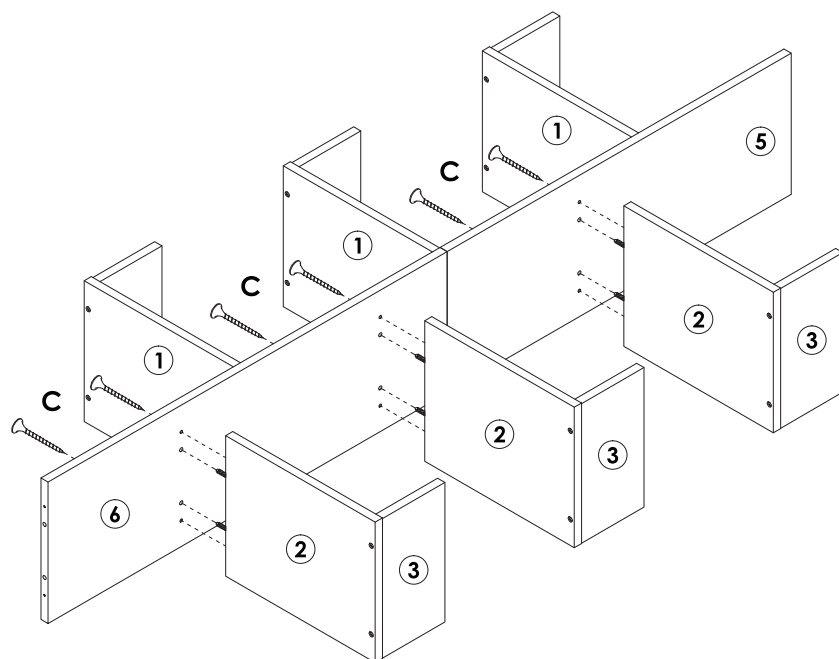

	C x 6PCS
	G x 6PCS

STEP 5





	C x 6PCS
	G x 6PCS

Assembly Steps(EN) / Montageschritte(DE)

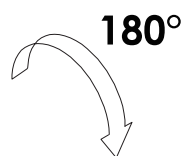
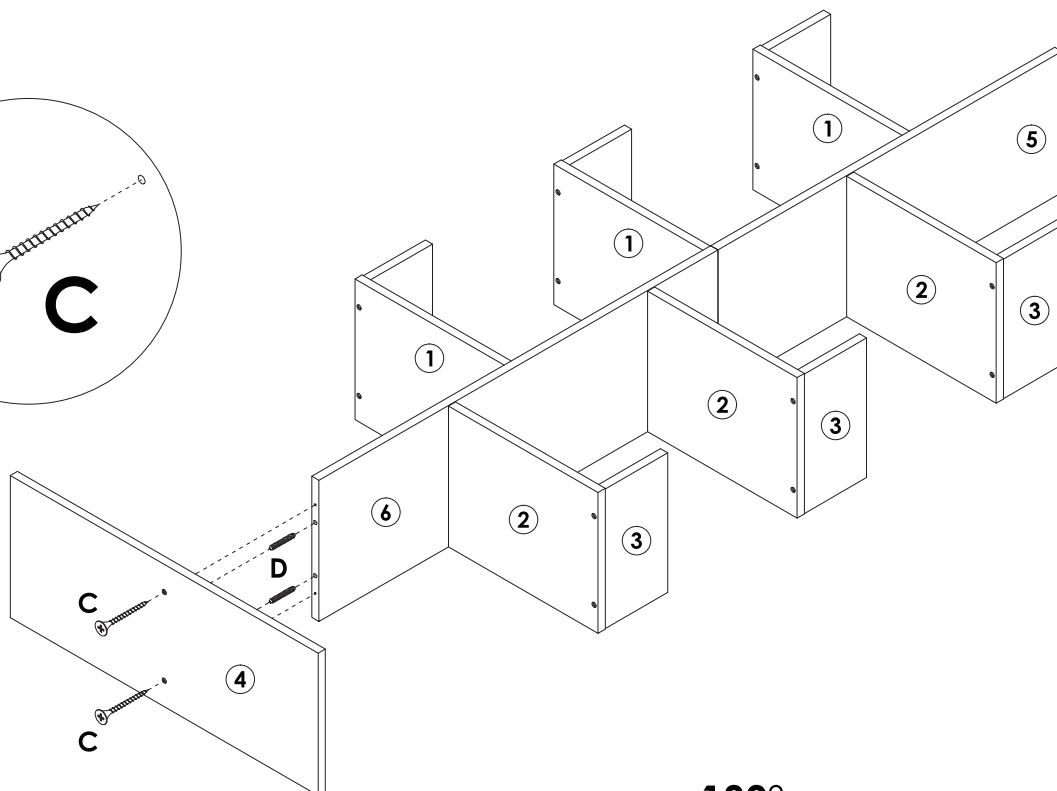
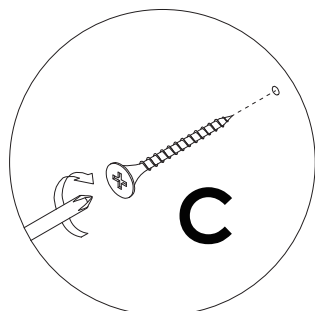
STEP 6

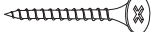

	C x 2PCS
	D x 2PCS

STEP 7

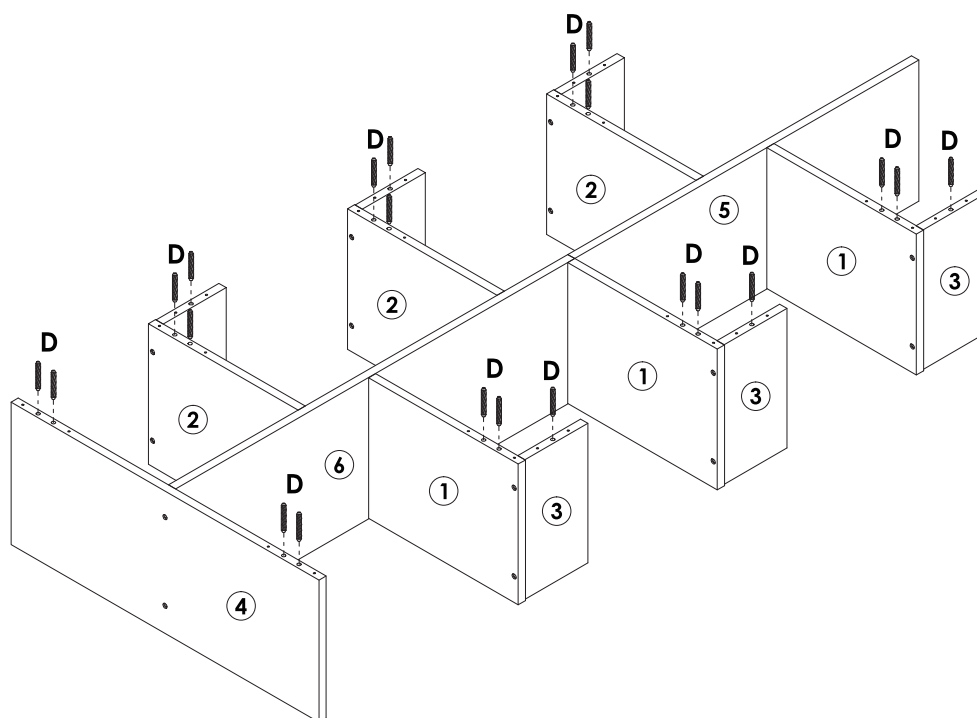



	D x 22PCS
---	------------------

Assembly Steps(EN) / Montageschritte(DE)

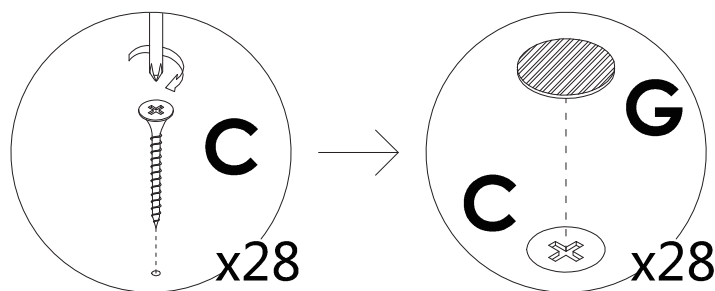
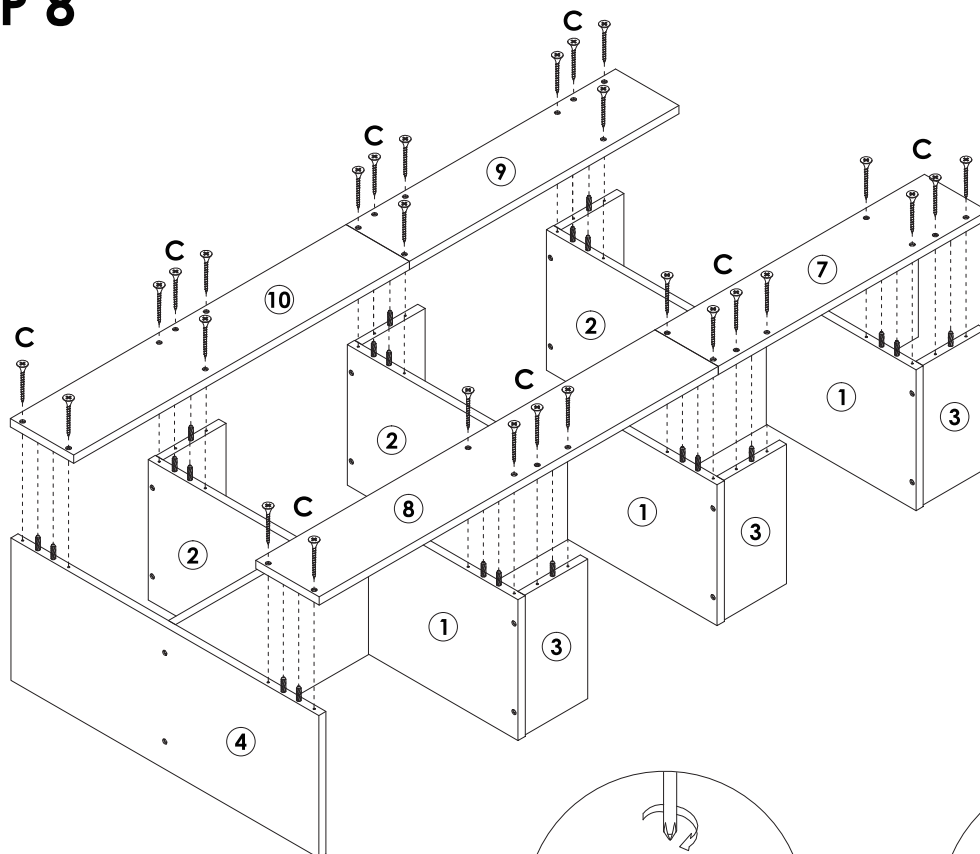
STEP 8



	C x 28PCS
	G x 28PCS

STEP 9

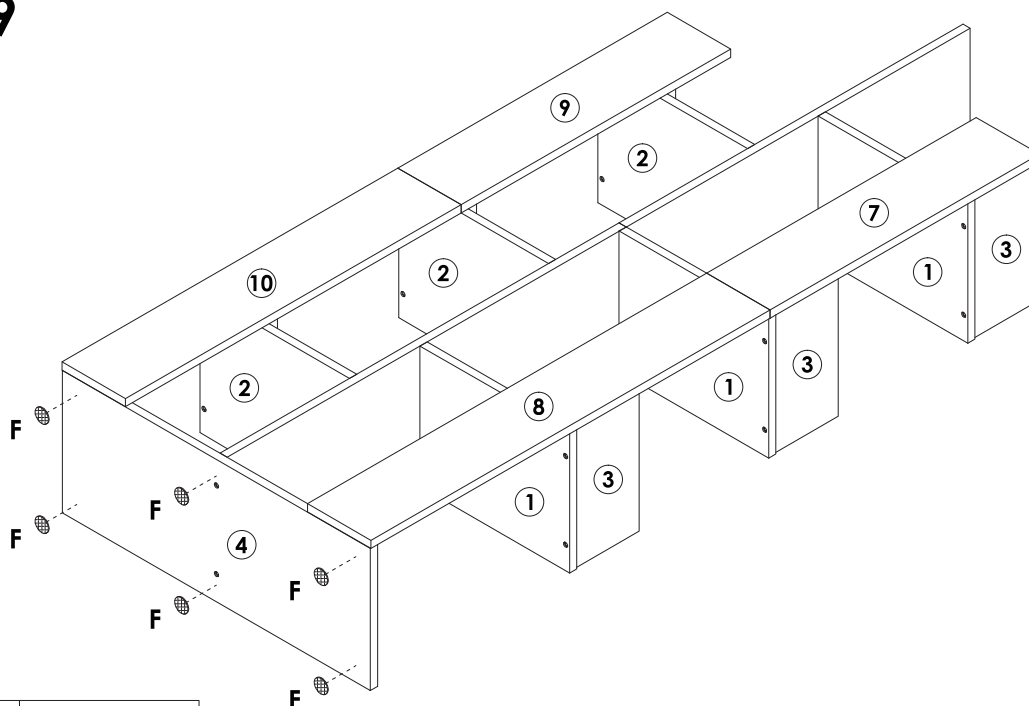



	F x 6PCS
---	-----------------

Assembly Steps(EN) / Montageschritte(DE)

STEP 10

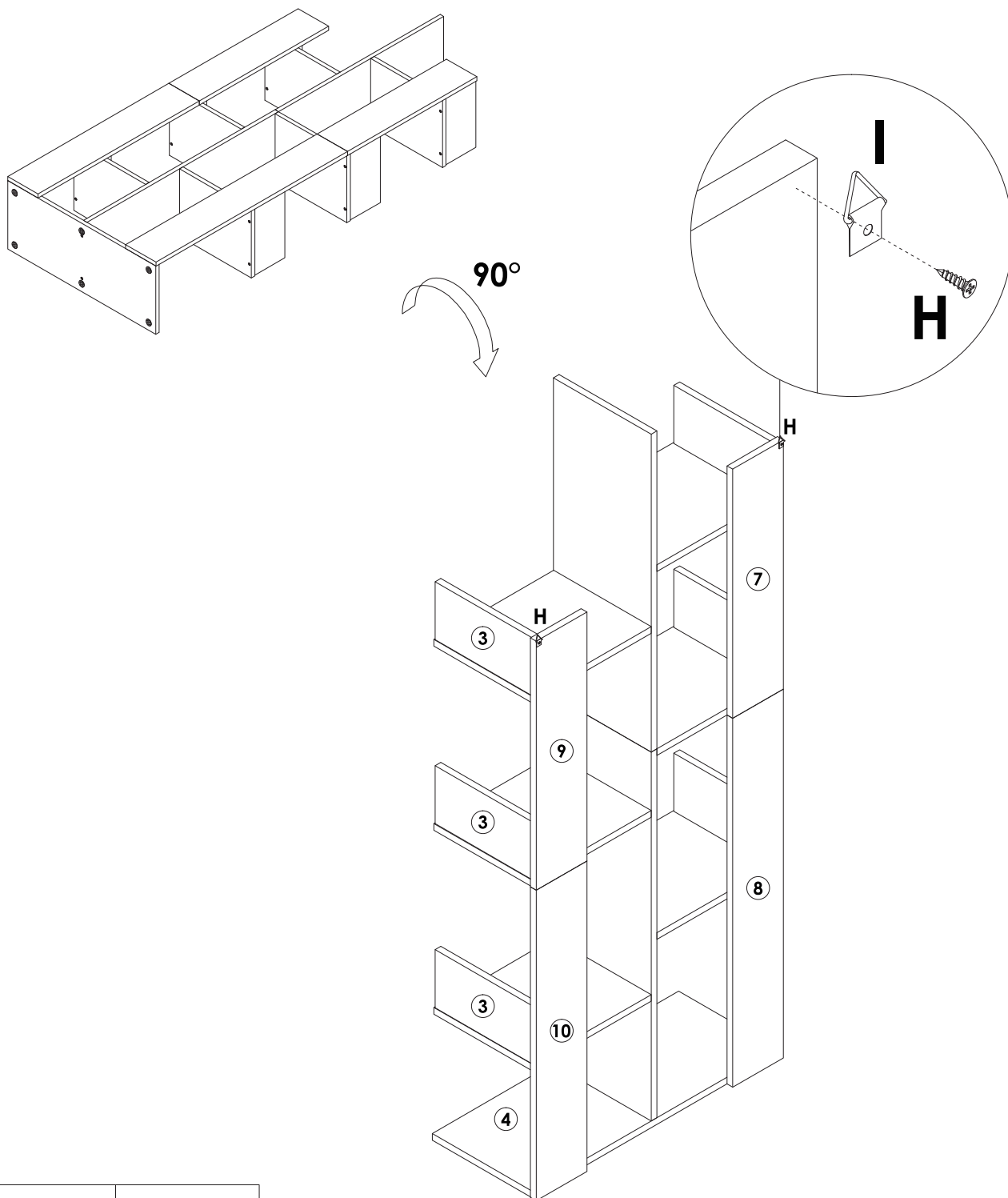
Use the "H" screw to lock the "I" Part on the back of the "7/9" board.



	H x 2PCS
	I x 2PCS



Assembly Steps(EN) / Montageschritte(DE)

STEP 11

After installation, move the cabinet to the position you need, and drill 2 holes on the wall at the corresponding position according to the height and position of the anti-falling device. Firstly, put the plastic screws "K" into 2 holes separately, and then use the "C" screws to lock the Parts "I" with the plastic screws "K" separately.

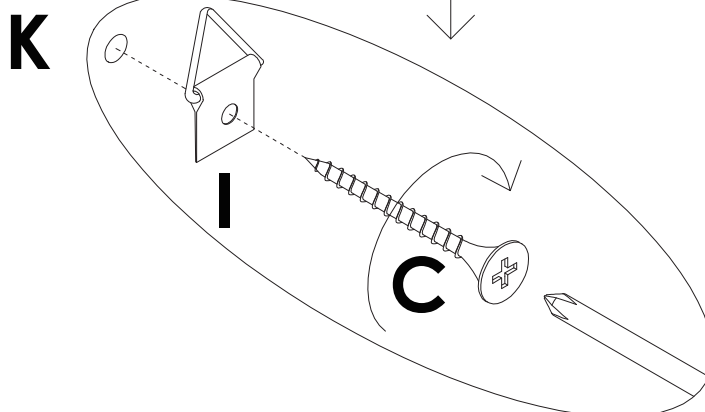
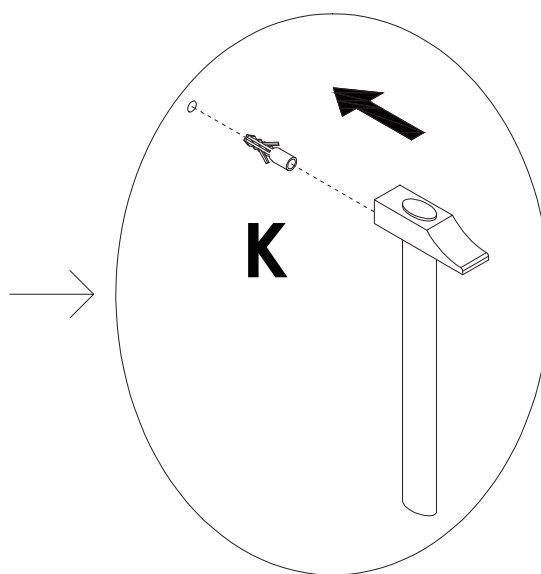
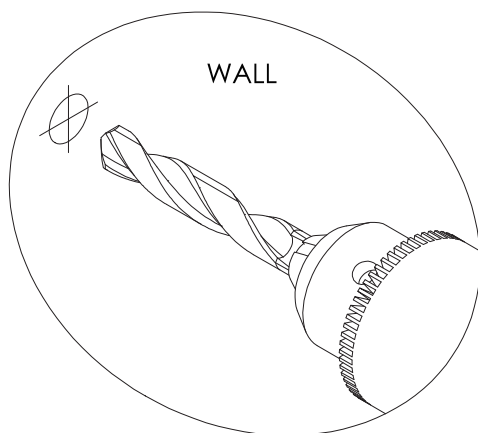
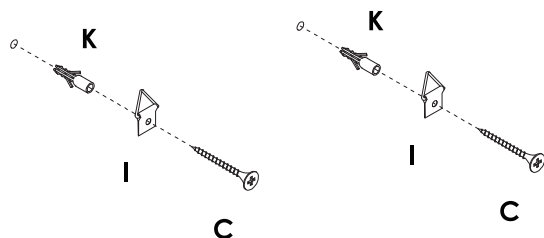
WALL

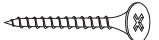

	C x 2PCS
	I x 2PCS
	K x 2PCS

Assembly Steps(EN) / Montageschritte(DE)

STEP 12

After that,move the cabinet to the corresponding position,then use the part "J" to pass through the part "I",and tighten it.The installation of the anti-falling device is completed.

WALL

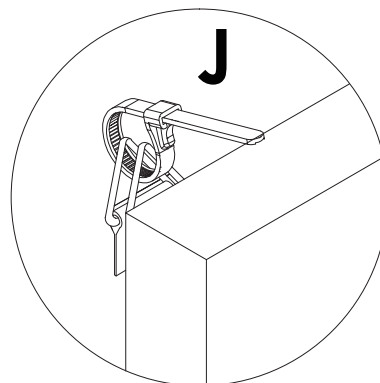
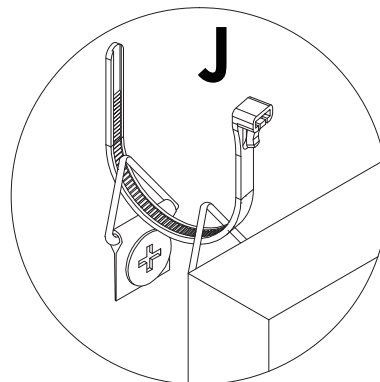
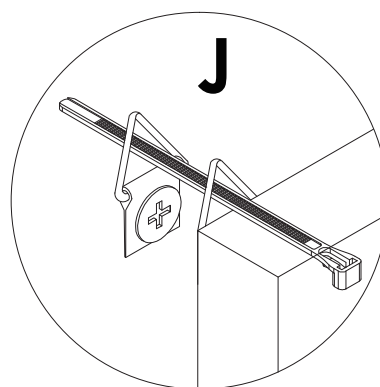
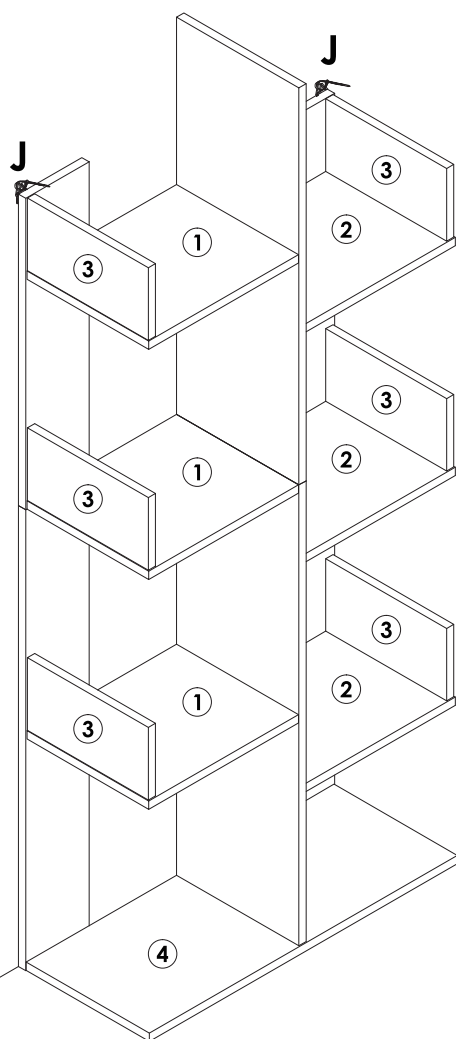

J x 2PCS



WARNING



Children have died from furniture tipover. To reduce the risk of furniture tipover:

- **ALWAYS** install tipover restraint provided.
- **NEVER** put a TV on this product.
- **NEVER** allow children to stand, climb or hang on drawers, doors, or shelves.
- **NEVER** open more than one drawer at a time.
- Place heaviest items in the lowest drawers.

