

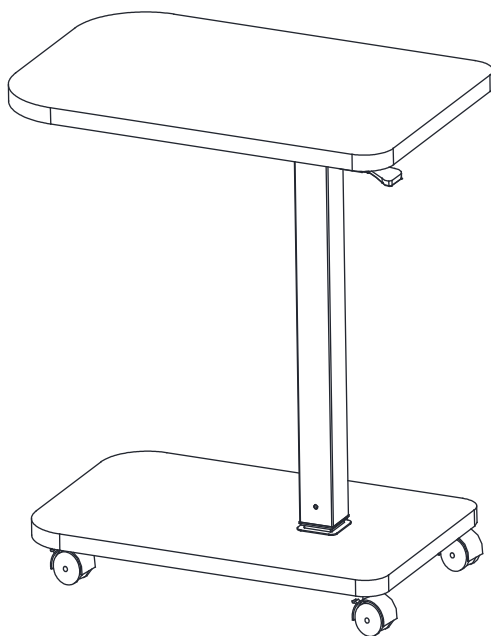

Elevating office desk

Operation guide



Before first use
Please read this manual carefully!
Be sure to follow the instructions!
Violation of the operation may result
in dangerous injury!
Please keep this manual!



Please read carefully
Retain important information for further reference

Matters needing attention

In order to avoid damage and injury caused by improper use please read this manual carefully before use.

The company does not assume any responsibility for the damage and human injury caused by the individual's failure to follow the instructions.

Assembly item













If it is used for the first time, please reset it. Please refer to Manual Controller Operation Guide.

It is recommended to check regularly whether the screw torque of the product is tightened to ensure safe use.

warning

All parts and packaging should be kept away from children and pets during assembly, as they may pose a potential hazard of injury and choking. Keep sharp objects or corrosive chemicals away from the product to prevent damage. When opening the box, sharp objects should be slowly prohibited to prevent scratching the product. Do not use in the sun or exposure for a long time to avoid discoloration.

Product list

Serial number	name	diagram	quantity
1	desktop		1
2	base		1
3	Table leg		1
4	Installation board		1
T	pulley		4
C	door mat		4
D	M6*20 screws		5
E	4MM wrench		1
F	M6*12 screws		8
G	M6*50 screws		6
H	Shim		6
L	4MM power tools		1
K	gusset plate		2

Step 1: Table leg assembly

- Use a 4MM wrench (E) and M6 * 20 screws (D) to assemble the mounting plate (4) onto the table frame (3).

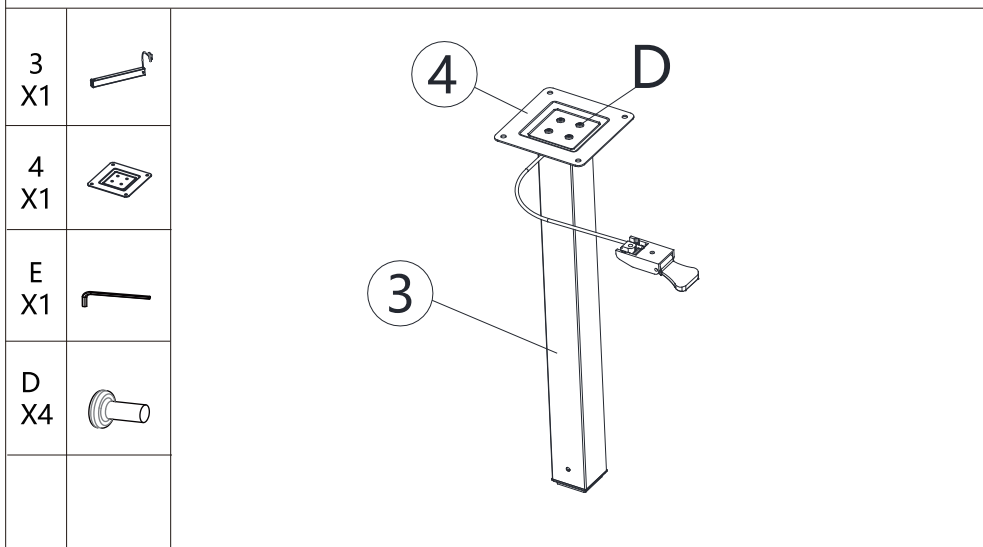

Step 2: Panel assembly

- Place the table leg assembly onto the reserved hole on panel (1) and use a 4MM wrench (E) to tighten the M6 * 12 screws (F)!

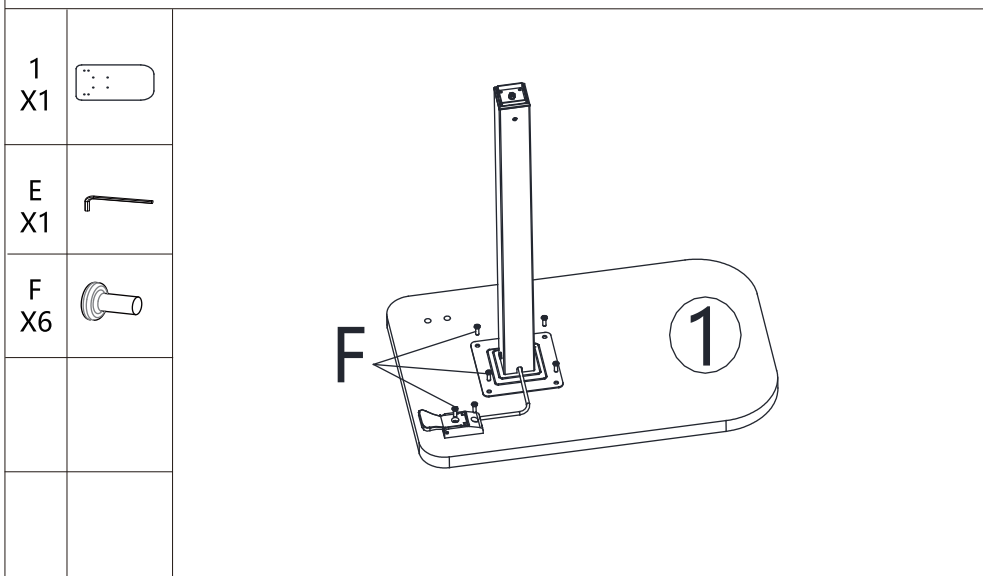

Step 3: Bottom plate assembly

- Attention: Before installation, it is necessary to keep the four screw holes on the fixed plate (I) aligned vertically!.
- Using a 4MM wrench (E), thread the M6 * 50 screw (G) through the fixed screw hole, confirm everything is normal, and then tighten the screw!

2 X1		
E X1		
G X4		
K X2		

Step 4: Foot pad assembly

- Screw the pulleys (T) into the reserved installation screws on the base plate in sequence. Before installation, add a washer (H).
- The pulley (T) can replace the foot pad (C)!

C X4		
H X4		
T X4		

Step 5: Lifting operation

- To ascend, press down on the handle and release to stop! Lower, press down on the handle, release to stop!

