

OPENING YOUR FUTON

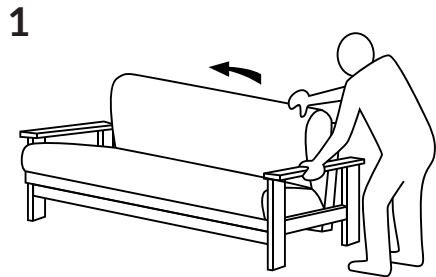

Standing to the side of your futon, place your hand on the back of the futon. Push the back of the futon forward. Hinge will release.

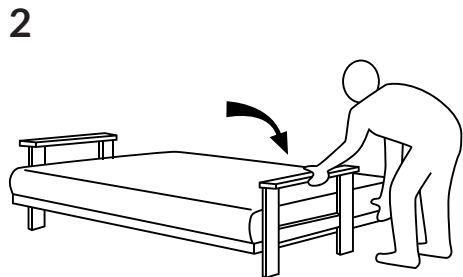

Gently pull on back of futon, and allow it to lie flat.

CLOSING YOUR FUTON

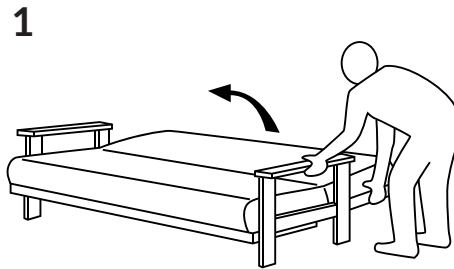

Place hand underneath back of futon, and lift again. Futon will lock into recline position, used for lounging.

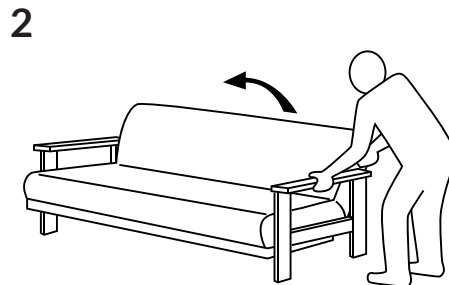

To sit up futon entirely, push forward on back once more. Futon will lock into full upright position, perfect for television, conversation, or similar activities.

FUTON FRAME

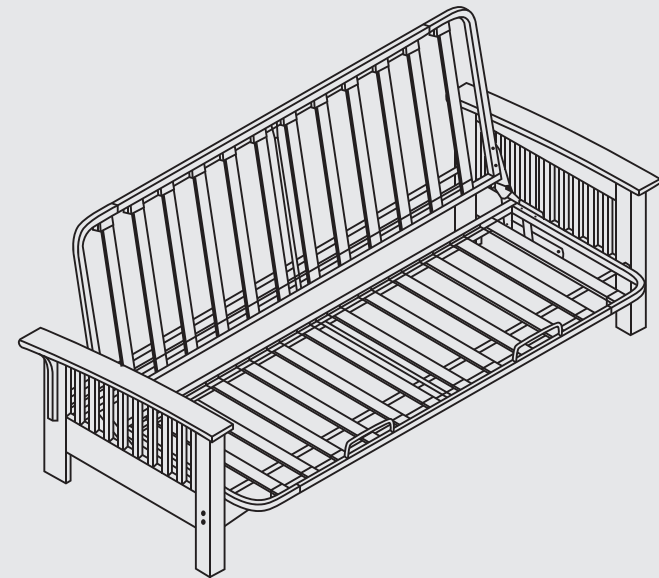

ADULT ASSEMBLY REQUIRED

If you are missing any parts or have any questions regarding assembly, do not return this item to the retailers store. Please call our toll-free, customer service number and have this assembly manual open to the parts list ready to provide the model name, number and part name or number.



WARNING: This product may contain small components, please ensure they are kept away from small children.

PARTS AND HARDWARE (ARM BOX)

Avoid using sharp objects such as a knife to cut open packing as you may accidentally damage the upholstery.

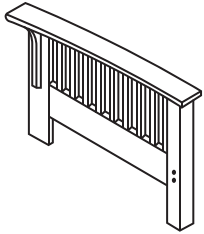

A. Left Arm
1x

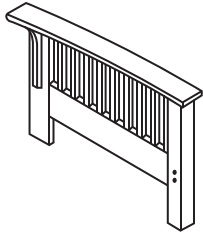

B. Right Arm
1x



C. M8x30 Bolt
4x



D. M8x95 Bolt
4x



E. Barrel Nut
4x

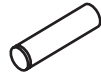

F. Dowel
2x



G. Allen Key
1x

7 Operate your futon frame by pushing the backrest forward, this will release the sofa to the bed position. Lift the backrest up to transition from bed position to either lounge or sofa position.

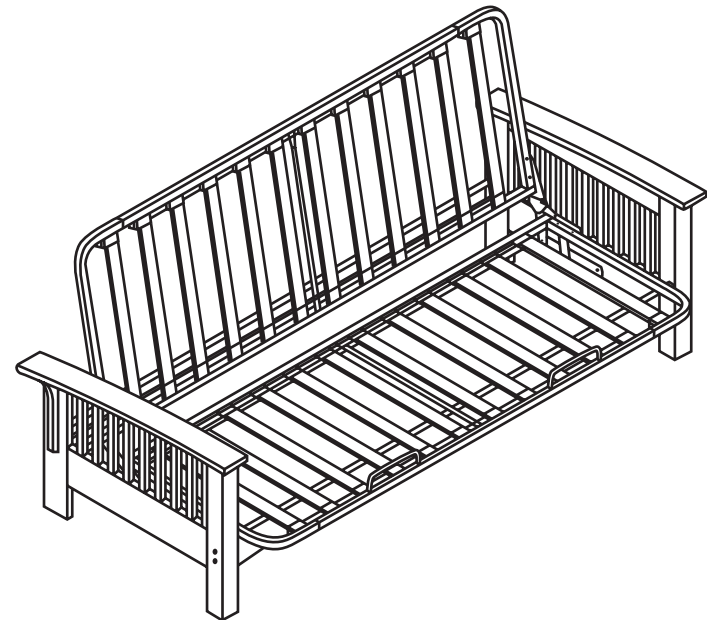
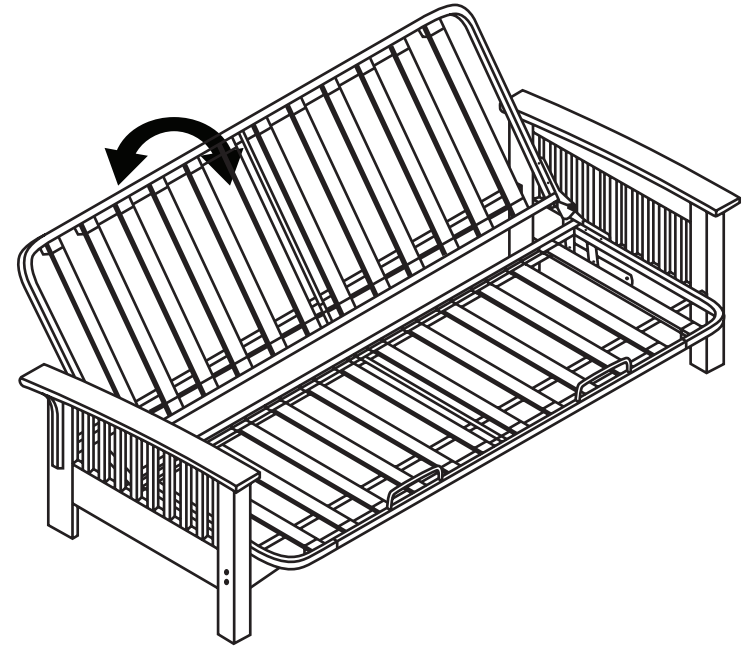

- 5** Attach the Beautyflex Slat System to the Metal Seat and Back Frame. Using the provided Plastic End Caps (8) and the Beautyflex Slats (20) start at one end of the seat frame and Attach the slats to the seat frame by placing the plastic end cap over the end of the slat and then firmly pressing down the plastic caps two teeth will click into the metal frame. Continue down the Seat until all slats have been attached. Repeat this step for the Back Frame.

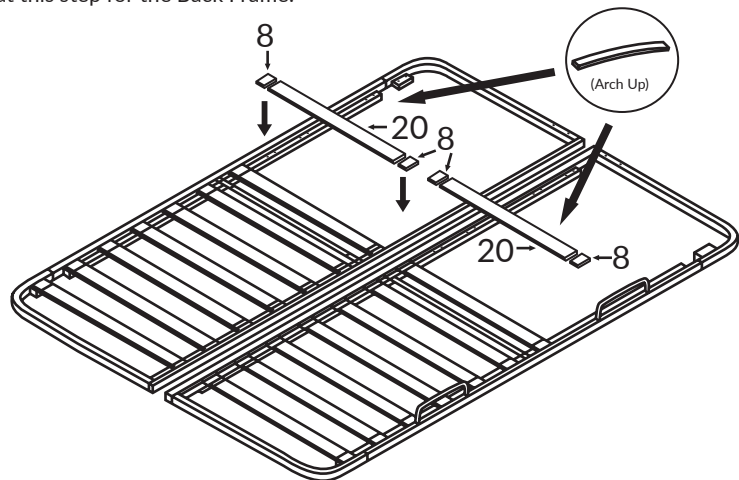

- 6** Attach the assembled seat deck to the front portion of the hinge (19) using 4x Bolt (3), 8x Washer (4), 4x Spring Washer (5), and 4x Nut (6). Tighten using the provided Allen Key and Spanner Wrench. Repeat this step for the Back Frame.

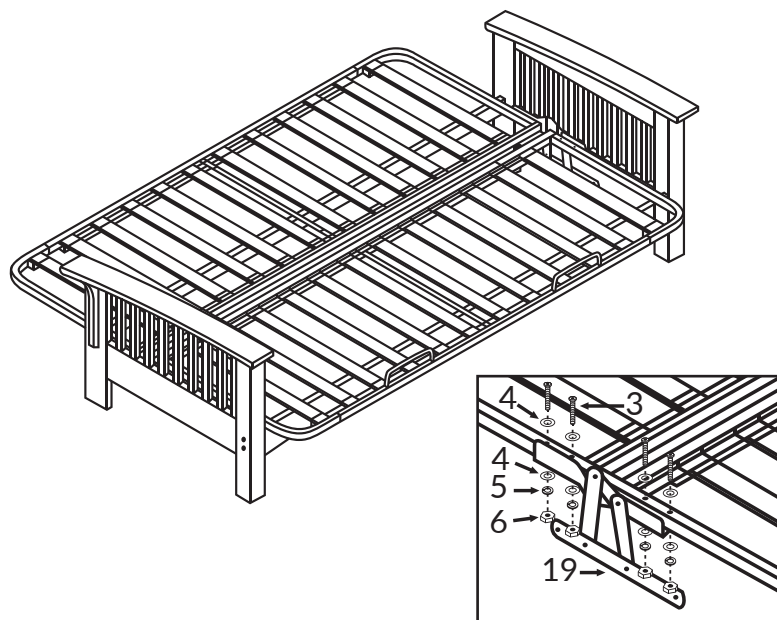

PARTS AND HARDWARE (BODY BOX)

Avoid using sharp objects such as a knife to cut open packing as you may accidentally damage the upholstery.



1. M6x20 Bolt
4x



2. M6x15 Bolt
12x



3. M8x40 Bolt
12x



4. Large Washer
16x



5. Spring Washer
8x



6. M8 Nut
8x



7. Small Washer
4x



8. Plastic End Cap
50x
(Spare 2pcs)



9. Spanner
1x



10. 4mm Allen Key
1x



11. 5mm Allen Key
1x

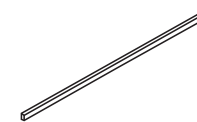

12. Back Stretcher Rail
1x

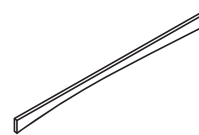

13. Front Stretcher Rail
1x



14. Seat Corner Rail
4x

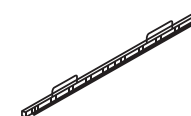

15. Seat Front Rail
1x



16. Back Rail
1x

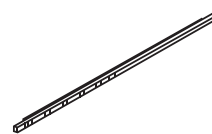

17. Middle Rail
2x

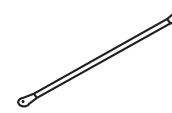

18. Support Rail
2x

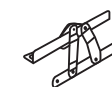

19. Hinge
2x

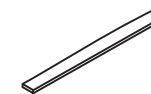

20. Beautyflex Slats
24x

ASSEMBLY INSTRUCTIONS

Do not fully tighten bolts until assembly is complete.

- 1 Before assembling left arm to left hinge, please ensure you've done the following. Open the Two Hinges inside your hardware kit. You will find an "L" Stamped into one of the hinges. This is the LEFT HINGE. Open the two arms packaged in the ARM BOX. You will find an "L" Sticker on one of your arms. This is the LEFT ARM.

After you have identified the LEFT hinge, and the LEFT arm. Attach hinge to arm using Bolt (1) and Washer (7) from the Body Box as shown below. Repeat for the Right Arm and Right Hinge.

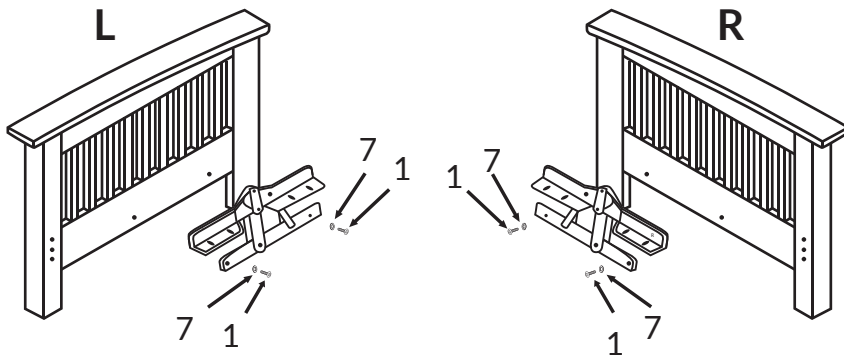

- 2 Attach Arms (A and B) to the Front Stretcher Rail (13) using the 4x Bolt (D), 2x Dowels (F) and 4x Barrel Nuts (E) that came in the ARM box hardware. Tighten using the provided Allen Key. Then attached Arms (A and B) to the Back Stretcher Rail (12) using 4x Bolt (C) that came in the ARM box hardware. Tighten using provided Allen Key.

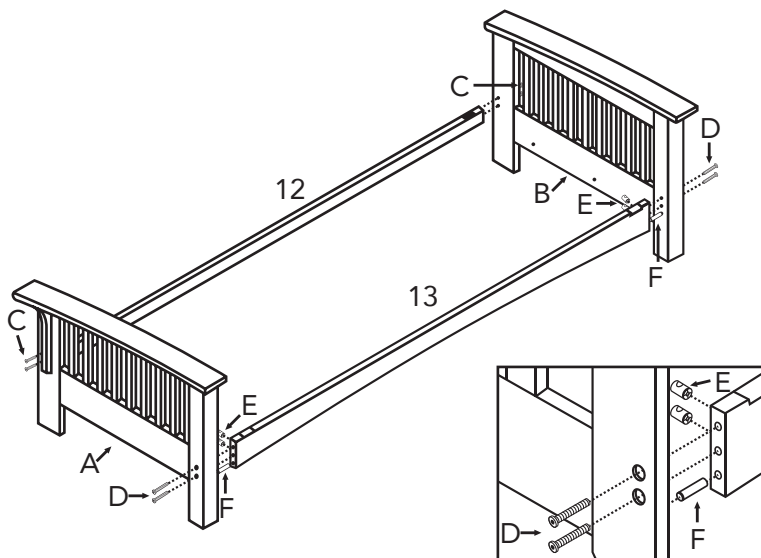

- 3 Assembling the Seat Frames - Lay out the metal frame which comprises the seat deck as shown in diagram below. Seat Requires the Middle Rail (17), 2x Seat Corner Rail (14) and Seat Front Rail (15). Once you have the frame laid out per diagram below attach using 2x Bolt (3), and 4x Bolt (2) that came in the BODY Box Hardware. Tighten using the provided Allen Key.

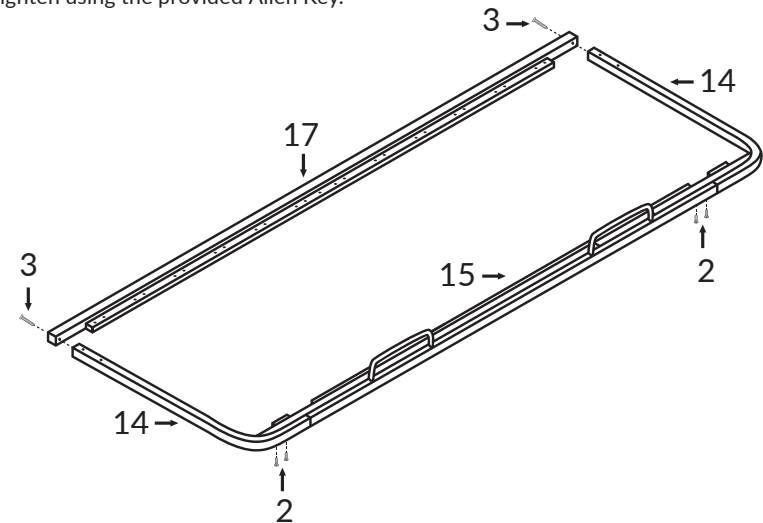

- 4 Once the Seat Frame is assembled, attach the Support Rail (18) using 2x Bolt (2) that came in the BODY box Hardware. Tighten using provided Allen Key.

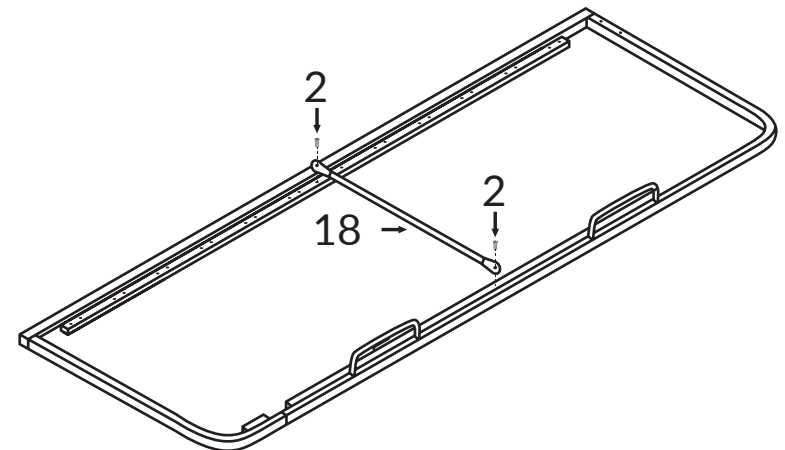

Repeat Steps 3-4 for the Back Frame.