

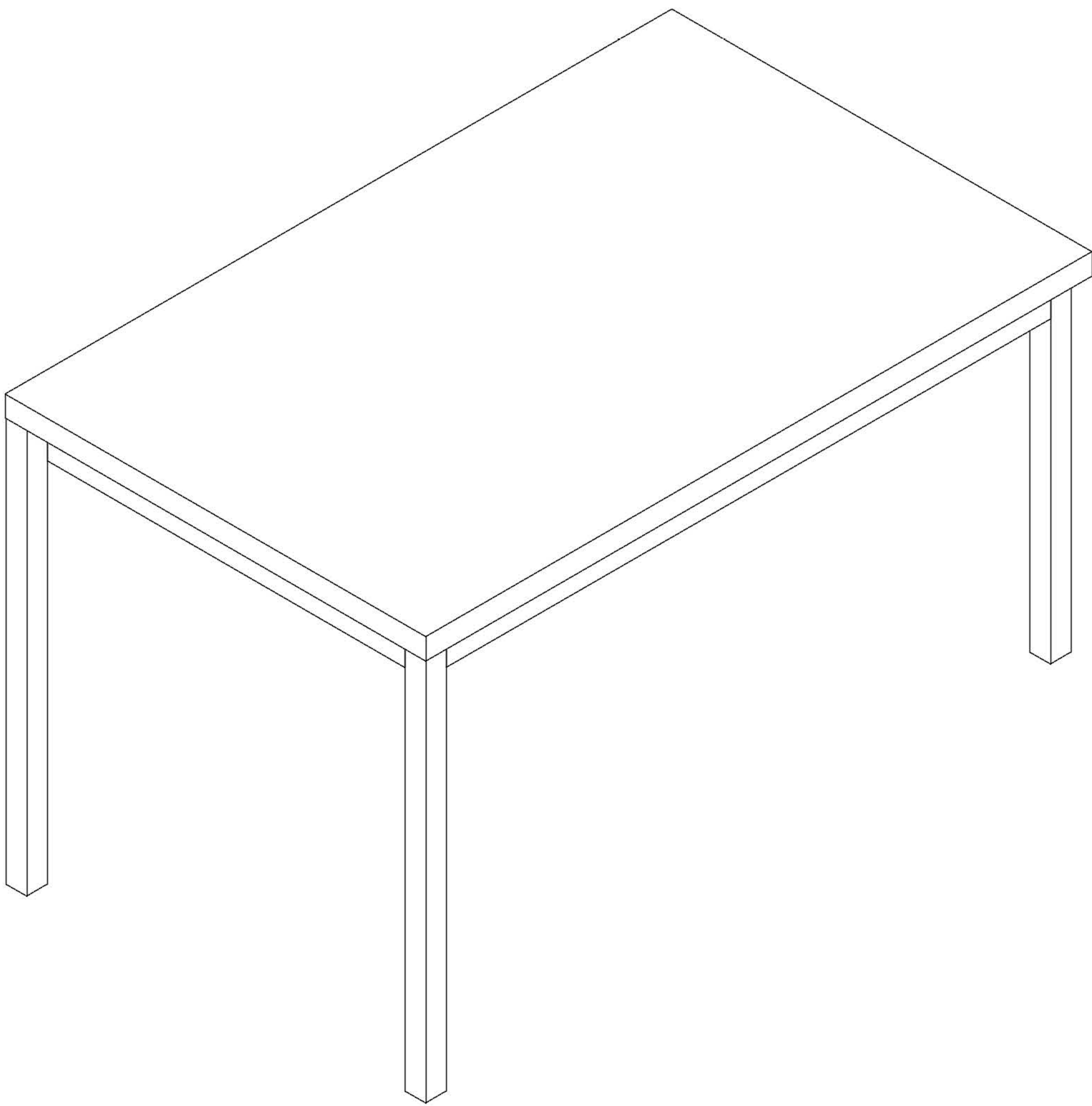





ASSEMBLY INSTRUCTIONS



NO.	PART LIST	QTY	NO.	PART LIST	QTY
A	 TOP	1	1	 5/16*41mm Allent Bolt	8
B	 Table Leg	4	2		8
			3		8
			4	 $\Phi 5/16''$ Allent Wrench	1

STEP 1

