

Assembly Instructions

⚠ Before you throw the carton, please ensure that you have all the parts needed for the assembly.

⚠ **Hardware Note:**
1. For each step please don't fully tighten all the screws at first, when they all align to the holes you can fully tighten them.

2. All the bolts should be assembled **vertically** to the holes.

⚠ **Spare parts** can be found in the hardware box if you do not have enough bolts for assembly.

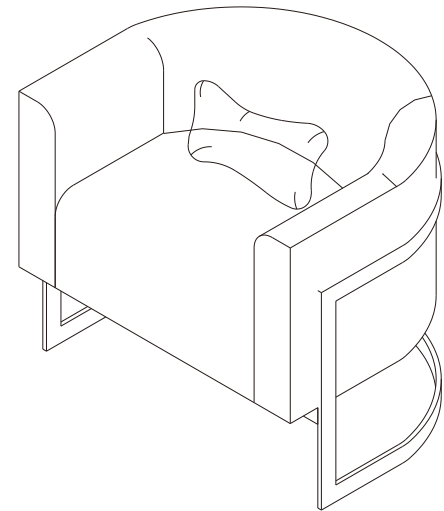

Assembly Instructions

Parts and Hardware

Please check to make sure you have all parts and hardware before starting assembly process.

(A)

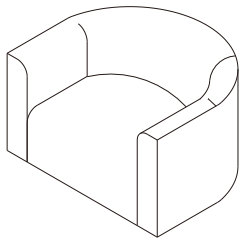

Seat x1

(B)

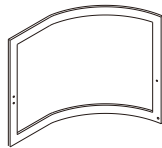

Left leg x1

(C)

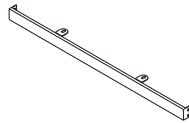

Front metal tube x1

(D)

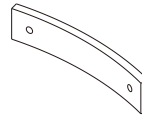

Metal plate x1

(E)

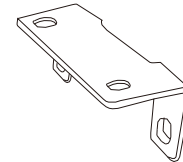

Metal plate x1

(F)

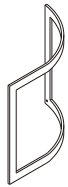

Right leg x1

(G)

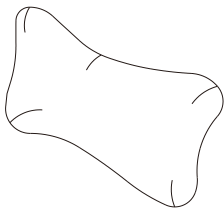

Pillow x1

①

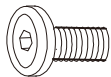

Short bolt x4

②

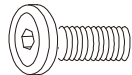

Middle bolt x4

③

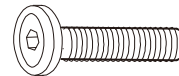

Long bolt x4
Remove the bolt from
under Part A (Seat)

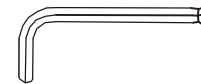

Wrench x1

spare parts

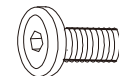

x1

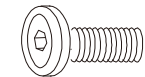

x1

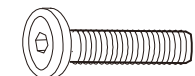

x1

Assembly Instructions

Assembly Instructions

Step 1 Before you throw the package, please ensure that you have all parts needed for the assembly.

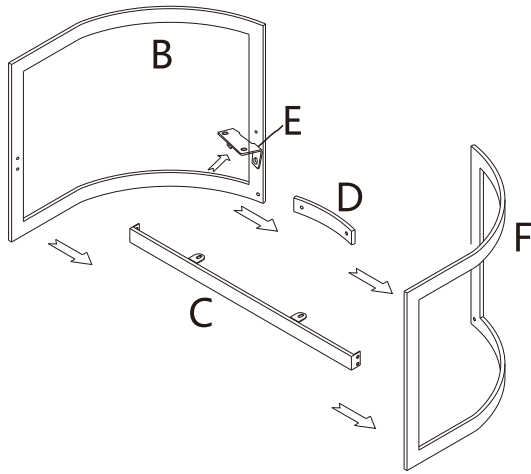

Step 2 Attach two legs use ① and bolts ① to tighten

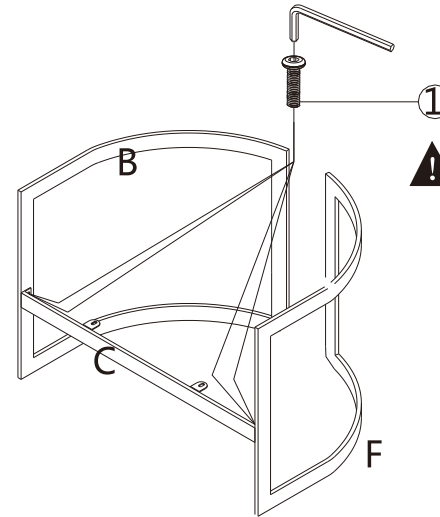

⚠ Please double check the length of the bolts only the short bolts can be used in the this step. Otherwise the legs will be broken.

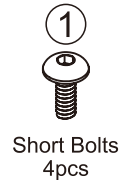

Step 3 Attach two legs use ④ & ⑤ and bolts ② to tighten

⚠ Please double check the length of the bolts only the middle bolts can be used in this step. Otherwise the legs will be broken.

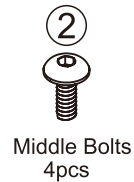
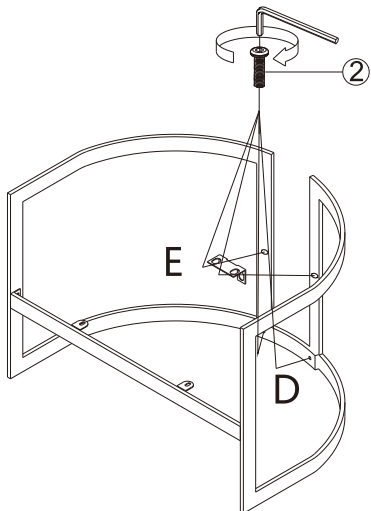

Step 4 Remove 4 long bolts from the bottom of part A.
Step 5 Attach assembled legs to seat use long bolts ③ to tighten

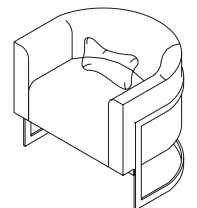
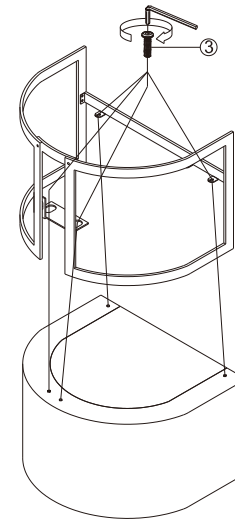
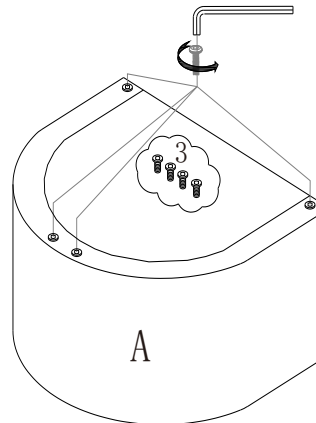

⚠ **Hardware Note:**
Please do not completely tighten all the hardware, until the entire assembly is complete.