

UPRIGHT FREEZER

User Manual

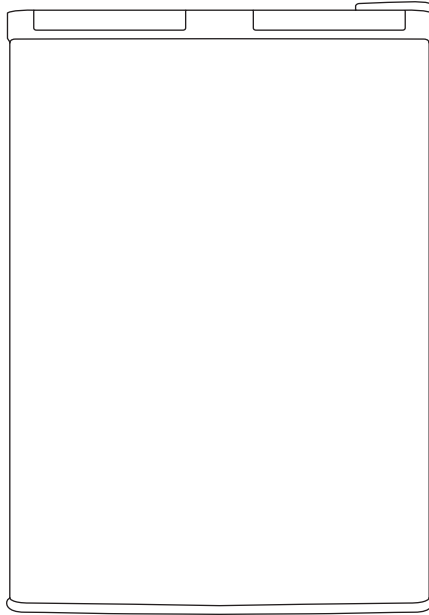

BD-88B-E

INDEX

Safety Precautions.....	3
Parts And Features.....	5
Installing Your Freezer.....	6
Unpacking Your Freezer.....	6
Adjusting Your Freezer.....	6
Proper Air Circulation.....	6
Freezer Features And Use.....	7
Operating Your Freezer	7
General Features	7
Normal Operating Sounds You May Hear	7
Leveling Your Freezer.....	7
Door Alignment	8
Food Storage Information	8
Proper Freezer Care and Cleaning	9
Cleaning and Maintenance	9
General	9
Door Gaskets.....	9
Power Interruptions.....	9
Vacation and Moving Care.....	10
Manual Defrosting Instructions	10
Troubleshooting	11





Safety Precautions

Read all of the instructions before using this appliance. When using this appliance, always exercise basic safety precautions, including the following:

1. Use this appliance only for its intended purpose as described in this use and care guide.
2. This freezer must be properly installed in accordance with the installation instructions before it is used. See grounding instructions in the installation section.
3. Never unplug your freezer by pulling on the power cord. Always grasp the plug firmly and pull it straight out from the outlet.
4. Repair or replace immediately, all electric service cords that have become frayed or otherwise damaged. Do not use a cord that shows cracks or abrasion damage along its length, the plug or the connector end.
5. Unplug your freezer before cleaning or before making any repairs.
Note: If for any reason this product requires service, we strongly recommend that a certified technician performs the service.
6. Do not use any electrical device or any sharp instrument in defrosting your freezer.
7. If your old freezer is not being used, we recommend that you remove the doors. This will reduce the possibility of danger to children.
8. After your freezer is in operation, do not touch the cold surfaces in the freezer compartment, particularly when hands are damp or wet. Skin may adhere to these extremely cold surfaces.
9. Do not refreeze foods, which have been thawed completely. The United States Department of Agriculture in Home and Garden Bulletin No.69 reads:"...You may safely refreeze frozen foods that have thawed if they still contain ice crystals or if they are still cold-below 40F".

"...Thawed ground meats, poultry, or fish that have any off-odor or off-color should not be refrozen and should not be eaten. Thawed ice cream should be discarded. If the odor or color of any food is poor or questionable, discard it. The food may be dangerous to eat."

"...Even partial thawing and re-freezing reduce the eating quality of foods, particularly fruits, vegetables, and prepared foods. The eating quality of red meats is affected less than that of many other foods. Use refrozen foods as soon as possible, to save as much of its eating quality as you can.

10. This refrigerator should not be recessed or built in an enclosed cabinet. It is designed for freestanding installation only.
11. Do not operate your refrigerator in the presence of explosive fumes.
12. Do not store explosive substances such as aerosol cans with a flammable propellant in this appliance.
13.  **WARNING:** keep ventilation openings, in the appliance enclosure or in the builtin structure, clear of obstruction.
14.  **WARNING:** do not use mechanical devices or other means to accelerate the defrosting process, other than those recommended by the manufacturer.
15.  **WARNING:** do not damage the refrigerant circuit.
16.  **WARNING:** do not use electrical appliances inside the food storage compartments of the appliance, unless they are of the type recommended by the manufacturer.

Save These Instructions For Future Reference Please

 **DANGER:** Risk of child entrapment. Before you throw away your old refrigerator or freezer:

- * Take off the doors.
- * Leave the shelves in place so that children may not easily climb inside.

Staple your receipt to your manual.
You will need it to obtain warranty service.

Parts And Features

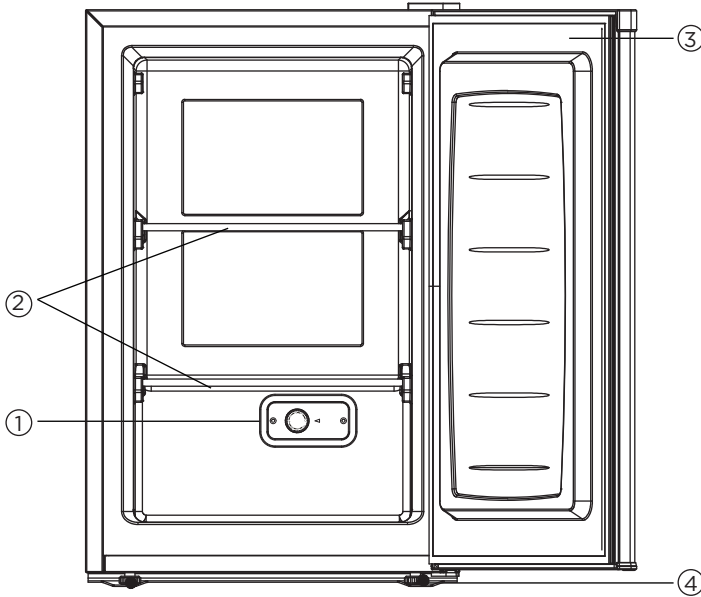

1. Adjustable Temperature Control
2. Removable Shelves
3. Door
4. Leveling Legs

Installing Your Freezer

Unpacking Your Freezer

1. Remove all packaging material. This includes the foam base and all adhesive tape holding the freezer accessories inside and outside.
2. Inspect and remove any remains of packing, tape or printed materials before powering on the freezer.

Adjusting Your Freezer

- Your freezer is designed for freestanding installation only. It should not be recessed or built-in.
- Place the freezer on a surface strong enough to support it fully loaded.
- When moving the freezer, never tilt it more than a 45-degree angle. This could damage the compressor and the sealed system.
- If the freezer is tilted let it stand in an upright position for at least 4 hours prior to plugging in. This is to allow the refrigerant to settle.

Proper Air Circulation

- To assure your freezer works at the maximum efficiency it was designed for, you should install it in a location where there is proper air circulation, plumbing and electrical connections.
- The following are recommended clearances around the freezer:
 - Sides.....4" (102mm)
 - Back.....4" (102mm)
 - Top.....4" (102mm)

Freezer Features and Use

Operating Your Freezer

- Once the freezer is in its proper place, plug it in an electrical outlet having 115 volts and 15 amps.
- Set the temperature, on the temperature control knob. “1” is the warmest and “7” is the coldest. Initially set the temperature on “4”. Place food inside the freezer. After using the freezer for 24 hours set the freezer to your desired setting.
- In case you unplug your freezer or experience an electrical outage, allow 5 minutes before plugging it back in.

General Features

Adjustable temperature dial:

Your freezer will automatically maintain the temperature level you select. The temperature control dial has 7 settings plus OFF. “1” is the warmest, and “7” is the coldest. Turning the dial to OFF stops cooling the freezer. Set the dial to “4” and allow 24 hours to pass before adjusting the temperature to your needs.

NOTE: If the freezer has been placed in a horizontal or tilted position for any period of time wait 24 hours before plugging the unit in.

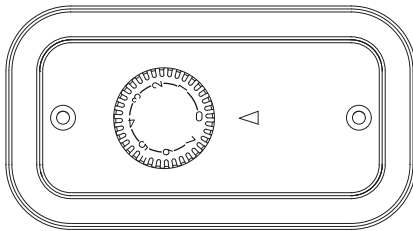

Control Panel
Varies by Model

Normal Operating Sounds You May Hear

- Boiling water, gurgling sounds or slight vibrations are the result of the refrigerant circulating through the cooling coils.
- The thermostat control will click when it cycles on and off.

Leveling Your Freezer

- Your freezer has two leveling legs which are located in the front bottom corners of your freezer. After properly placing your freezer in its final position, you can level your freezer.

- Leveling legs can be adjusted by turning them counterclockwise to raise your freezer or by turning them clockwise to lower your freezer. The freezer door will close easier when leveling legs are extended.

Door Alignment

1. Remove the top hinge cover using a flat head screw driver. Gently lift from the rear of the hinge and slide forward.
2. Loosen the top hinge screws using a Phillips head screwdriver.
3. Adjust the door or put a spacer in between and then tighten the screws.
4. Replace the top hinge cover by aligning the rear of the cover with the rear of the hinge. Press firmly on the front of the cover until it snaps in place.

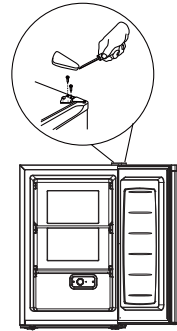

Food Storage Information

Frozen Food:

- Wipe containers before storing to avoid needless spills.
- Hot food should be allowed to cool before storing it in the freezer. This will prevent unnecessary energy use.
- When storing meats, keep them in the original packaging or rewrap as necessary.
- Proper freezer storage requires correct packaging. All foods must be in packages, which prevents the flow of air or moisture, improper storage will result in odor and taste transfer and will result in the drying out of the improperly packaged food.
- Follow package or container instructions for proper storage.
- Packaging Recommendations:
 - Plastic containers with air-tight lids
 - Heavy-duty aluminum foil
 - Plastic wrap made from saran film
 - Self-sealing plastic bags
- Do not refreeze defrosted/thawed foods.
- It is recommended that the freezing date be marked on the packaging.

These are some suggestions for safe storage:

- TV Dinners 3 - 4 Months
- Fresh Shrimp, scallops, crawfish 3 - 6 Months
- Hamburger & stew meats 3 - 4 Months
- Ground Turkey, veal, pork 3 - 4 Months
- Chops 4 - 6 Months
- Steaks 6 - 12 Months
- Chicken or turkey, a whole year

Proper Freezer Care and Cleaning

Cleaning And Maintenance

WARNING

To avoid electric shock always unplug your freezer before cleaning. Ignoring this warning may result in death or injury.

CAUTION

Before using cleaning products, always read and follow manufacturer's instructions and warnings to avoid personal injury or product damage.

General

- Prepare a cleaning solution of 3-4 tablespoons of baking soda mixed with warm water. Use a sponge or soft cloth, dampened with the cleaning solution, to wipe down your freezer.
- Rinse with clean warm water and dry with a soft cloth.
- Do not use harsh chemicals, abrasives, ammonia, chlorine bleach, concentrated detergents, solvents or metal scouring pads. SOME of these chemicals may dissolve, damage and/or discolor your freezer.

Door Gaskets

- Clean door gaskets every three months according to general instructions. Gaskets must be kept clean and pliable to assure a proper seal.
- Petroleum jelly applied lightly on the hinge side of gaskets will keep the gasket pliable and assure a good seal.

Power Interruptions

- Occasionally there may be power interruptions due to thunderstorms or other causes. Remove the power cord from AC outlet when a power outage occurs. When power has been restored, replug power cord to AC outlet. If outage is for a prolonged period, inspect and discard spoiled or thawed food in freezer. Clean freezer before reusing.

Vacation And Moving Care

- For long vacations or absences, empty food from freezer, move the temperature DIAL to the OFF position and clean the door gaskets according to “General cleaning” section. Prop doors open, so air can circulate inside. When moving always move the freezer vertically. Do not move with the unit lying down. Possible damage to the sealed system could occur.

WARNING

If outage is for a prolonged period, inspect and discard spoiled or thawed food in freezer. Clean freezer before reusing.

Manual Defrosting Instructions

Manual Defrost Freezer models must be defrosted manually. For best operation, the freezer should be defrosted when the frost accumulation becomes 1/4 to 1/2 inch thick. Below are the instructions for manually defrosting your Freezer.

Defrosting Instructions for Freezers:

- Turn the temperature control to OFF and unplug the freezer.
- Remove all food and place it in corrugated boxes, insulated bags, picnic coolers, etc. Use towels and newspapers for insulation, as needed.
- Remove the drain plug (on models so equipped).
- With the door open, use pans of hot water to speed the loosening of frost. Remove large pieces of frost before they melt.
- Sponge the excess water from the bottom of the freezer as it collects to prevent overflowing.
- After defrosting, clean the inside of the freezer by wiping it down with a baking soda and water solution. Rinse and dry.
- Be sure to replace drain cap (on models so equipped). Return the drain tube to its position and replace the grille.
- Plug the freezer in, return the temperature control to the normal position and return food to the freezer.

Troubleshooting

Freezer Does Not Operate

- Check if thermostat control is not in the “OFF” position.
- Check if freezer is plugged in.
- Check if there is power at the ac outlet, by checking the circuit breaker.
- Wait for 30-40 minutes to see whether freezer will start. Compressor cycle must be complete to operate.

Food Temperature Appears Too Warm

- Frequent door openings.
- Allow time for recently added warm food to reach freezer temperature.
- Check gaskets for proper seal.
- Clean condenser coils (for models with exposed condenser coils).
- Adjust temperature control to colder setting.

Food Temperature Is Too Cold

- If temperature control setting is too cold, adjust to a warmer setting and allow several hours for temperature to adjust.

Compressor Runs Too Frequently

- This may be normal to maintain constant temperature during high temperature and humid days.
- Doors may have been opened frequently or for an extended period of time.
- Check gasket for proper seal.
- Check to see if doors are completely closed.
- Check freezer compartment for blockage from frozen food packages, containers, etc.

Freezer Has An Odor

- Interior needs cleaning.
- Foods improperly wrapped or sealed are giving off odors.