

Instruction Manual

175cm Rectangular Dining Table, Brushed Light Acacia

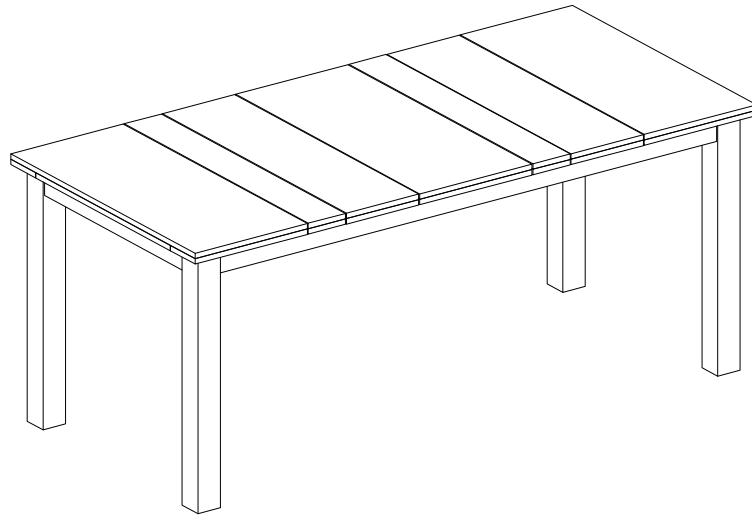

CONTENTS

Safety and care advice	1
Components	2
Assembly instructions	4
Copyright	8



⚠ SAFETY AND CARE ADVICE ⚠

PLEASE READ THESE INSTRUCTIONS CAREFULLY AND KEEP FOR FUTURE REFERENCE

- **Warning:** Please lift with care.
- Check you have all the components and tools listed on pages 2 and 3.
- Remove all fittings from the plastic bags and separate them into their groups.
- Keep children and animals away from the work area, small parts could choke if swallowed.
- Make sure you have enough space to lay out the parts before starting.
- Do not stand or put weight on the product, this could cause damage.
- Assemble the item as close to its final position (in the same room) as possible.
- Assemble on a soft level surface to avoid damaging the unit or your floor (use opened out unit carton).



- We do not recommend the use of power drill/drivers **for inserting screws**, as this could damage the unit. Only use hand screwdrivers.
- Dispose of all packaging carefully and responsibly.

CARE AND MAINTENANCE

- Only clean using a damp cloth and mild detergent, do not use bleach or abrasive cleaners.
- From time to time check that there are no loose screws on this unit.
- This product should not be discarded with household waste. Take to your local authority waste disposal center.

Note *If required the next page can be cut out and used as reference throughout the assembly. Keep this page with these instructions for future reference.*

COMPONENTS

Please check you have all the panels listed below:

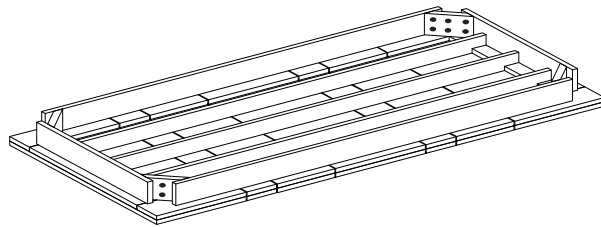
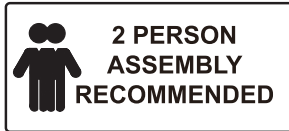

① X1

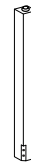

② X4

- | | |
|--------------|-----|
| 1. Table Top | x 1 |
| 2. Leg | x 4 |



COMPONENTS

Please check you have all the fittings listed below:



Bolt ($\Phi 8 \times 60 \text{mm}$) x 8



Washer ($\Phi 8 \times 20 \times 1 \text{mm}$) x 8

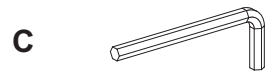



Allen key x 1



ASSEMBLY INSTRUCTIONS

Step 1

A		8	
B		8	
C		1	

