

# ASSEMBLY INSTRUCTIONS

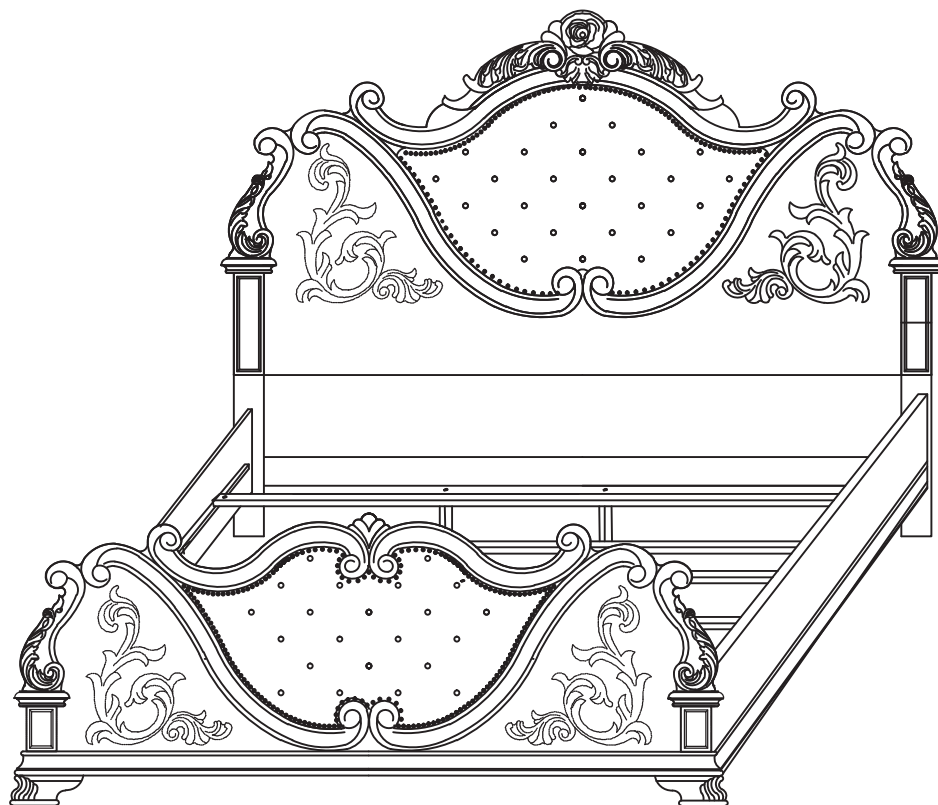

## TOOLS REQUIRED



Allen Wrench

(Included)



Phillips  
Screwdriver

(Not Included)



2 - People  
Recommended

## ASSEMBLY RATING



EASY —————> DIFFICULT

The Assembly Rating is a 5-point system showing the level of effort needed to assemble a specific product.



## **CHECK BEFORE STARTING**

### **Are you missing anything?**

Double-check all parts, hardware and accessories listed are all accounted for.

### **Check out our Quick Tips!**

We recommend reviewing the pre-assembly handouts. Even experts need a refresher now and then!

### **Should we send any replacements?**

Are there any irregularities or flaws in the parts? We can send replacements!

### **Prep Time!**

Please review the assembly instructions and all diagrams prior to assembling.

# PRE ASSEMBLY INTRODUCTION

We understand building ready-to-assemble furniture can be a challenging experience for some. To help avoid confusion, we have provided some helpful tips that may speed up the process.



## Teamwork

ALWAYS have at least two people to help with transporting and assembling the product to avoid potential injury and/or damage.



## Suitable Location

Assembling near the area of the intended location is highly recommended.



## Sufficient Space

Make sure you have enough space to move around during the assembly.



## Avoid Scratches

Use cardboard, blankets or a carpeted area while assembling furniture to prevent to prevent scratches and damages.



## Flat Surface

Make sure the furniture rests on a flat and level surface with each leg evenly touching the floor.

# ASSEMBLY AND CARE ADVICE



**FAILURE TO FOLLOW THE GUIDELINES BELOW MAY RESULT IN INJURY AND/OR PROPERTY DAMAGE.**



Position each part correctly and insert screws or bolts into their respective holes.



Turn clockwise to tighten and only tighten when step is completed or when instructed to do so.



Use the appropriate hand tools or power tools for assembly. Select steps, such as tightening screws and/or bolts, may require hand tools to avoid causing damage during assembly.



Save the instructions and store any supplied tools for later maintenance.



After two weeks, check and tighten any loose hardware and repeat again every six months thereafter.

**IT IS THE USER'S RESPONSIBILITY TO MAINTAIN THE FURNITURE. THE HARDWARE MAY LOOSEN OVER TIME AND MAY CAUSE THE FURNITURE TO BE WOBBLY AND UNABLE TO SUPPORT ITS INTENDED WEIGHT CAPACITY. THIS MAY LEAD TO COLLAPSE AND MAY CAUSE SERIOUS INJURY.**

# BED

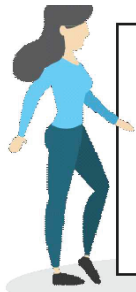

- Please keep instructions for future reference.
- Check the quantity and irregularity of parts and hardware before you start.

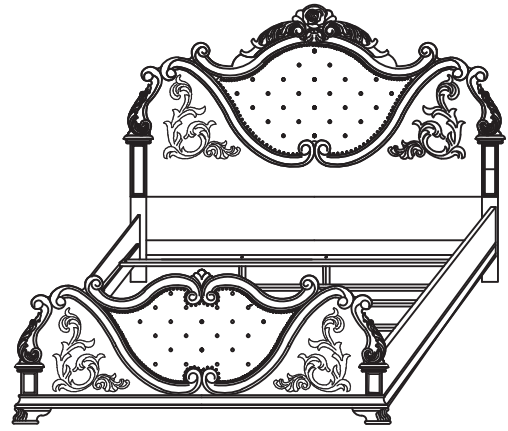

## PARTS

#1 1pc



Headboard

#2 2pcs



Headboard leg(L&R)

#3 1pc

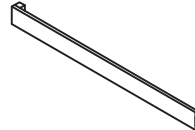

HB Cross bar

#4 1pc



Footboard

#5 2pcs

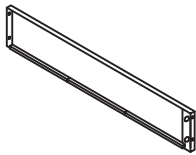

Siderail

#6 4 pcs

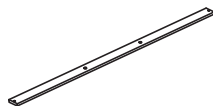

Slat

#7 8pcs

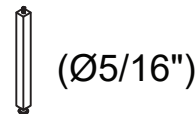

Slat support leg  
250x30x30mm

## HARDWARE

#A 8pcs



Bolt Ø5/16" x 2"

#B 12pcs



Lock Washer Ø5/16"

#C 12pcs



Flat Washer Ø5/16"

#D 1pc



Allen key M4

#E 8pcs



Screw #4 x 32mm

#F 8pcs



Ø5/16" x 3-1/4"

# HARDWARE

#G 8pcs



Half Moon Washer  
(Ø5/16")

#H 8pcs



Hex Nut (Ø5/16")

#I 1pcs



Wrench 14mm







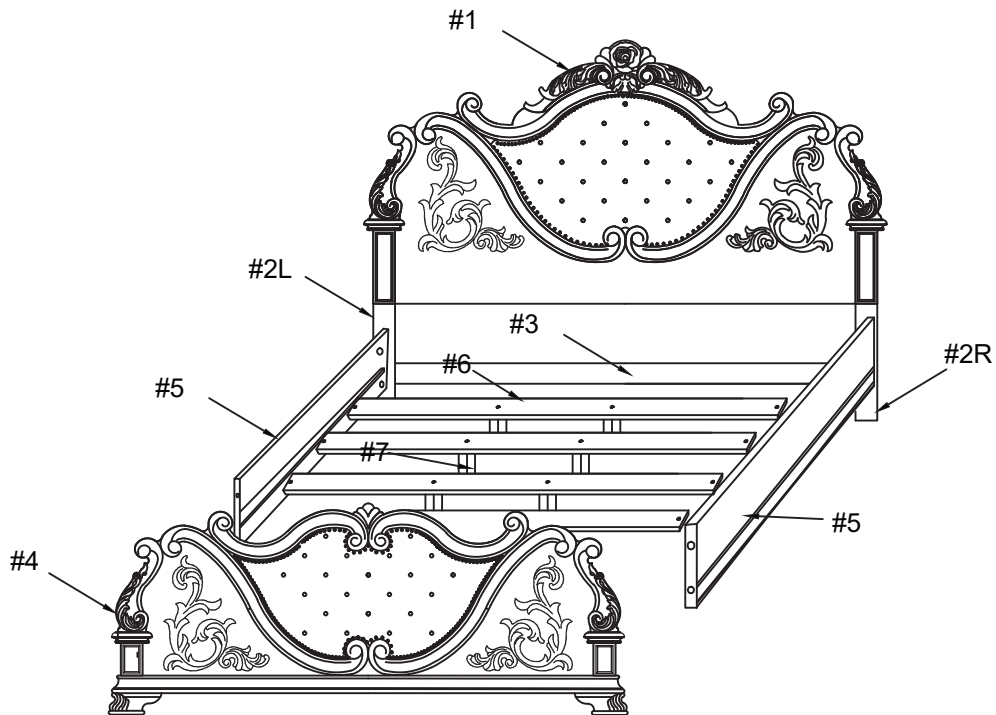









#J 4pcs



Bolt Ø5/16" x 1-1/2"

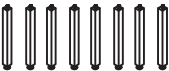

# packed in 3 cases

Carton	Disignation	Part	Hardware
	Headboard	#1 	
	Headboard leg(L&R) x 2pcs	#2 	
	HB Cross bar	#3 	
	Footboard	#4 	 #A x8pcs  #B x12pcs  #C x12pcs  #D x1pc  #E x8pcs  #F x8pcs  #G x8pcs  #H x8pcs  #I x1pc  #J x4pcs
	Slat x 4pcs	#6 	
	Slat support leg 190x30x30mm x8pcs	#7 	
	Siderail x 2pcs	#5 	

# ASSEMBLY INSTRUCTIONS

Align the Headboard leg L&R (#2) to the back of Headboard (#1) and secure by using Bolt (#A) with Lock washer (#B) and Flat washer (#C).

## 1

Part #1 x1pc

Part #2 x2pcs

Hardware #A x8 pcs

Hardware #B x8 pcs

Hardware #C x8 pcs

Hardware #D x1 pc

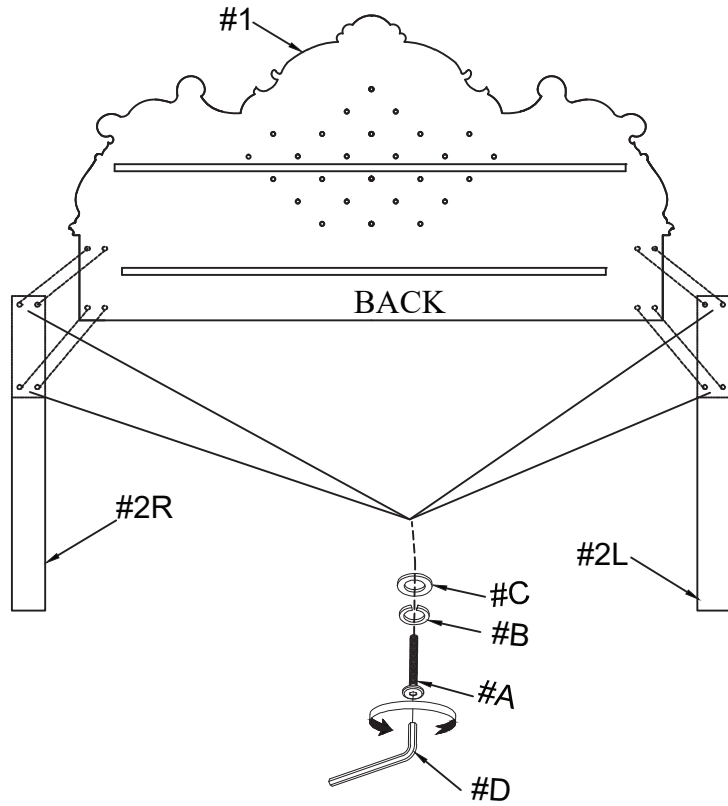

## 2

Part #3 x1pc

Hardware #J x4 pcs

Hardware #B x4 pcs

Hardware #C x4 pcs

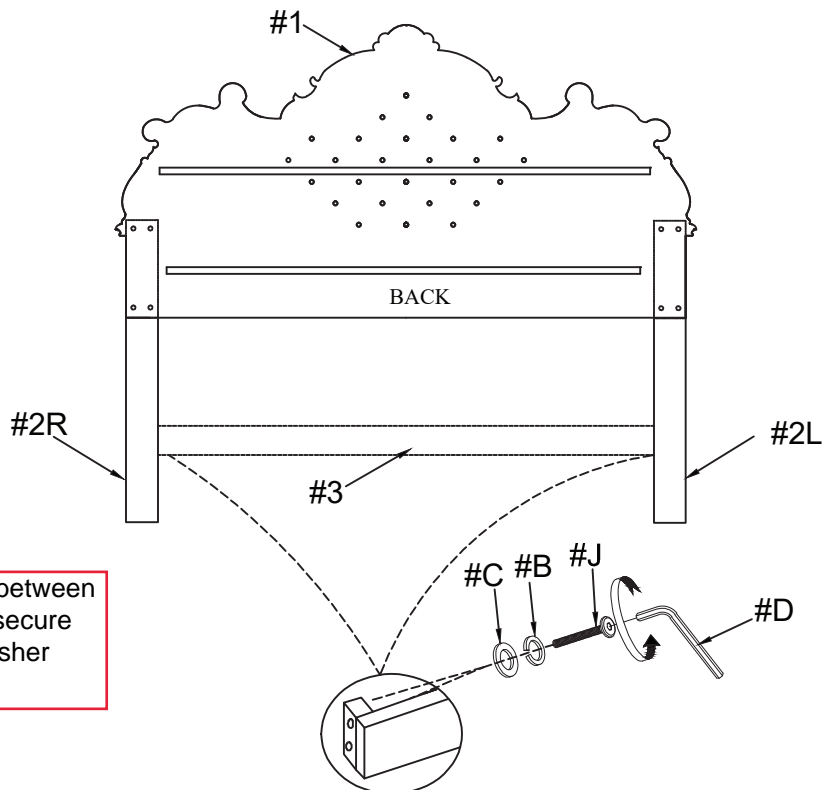

Insert the HB cross bar (#3) in between the Headboards legs (#2) and secure by using Bolt (#J) with Lock washer (#B) and Flat washer (#C).

# ASSEMBLY INSTRUCTIONS

## 3

Part #4 x1pcs

Part #5 x2pcs

Hardware #H x8 pcs

Hardware #G x8pcs

Hardware #F x8pcs

Attach Part # F to the Headboard legs (#2) and the Footboard (#4). Align the Side rails (#5) and secure with Half moon washer (#G) and Hex nut (#H).

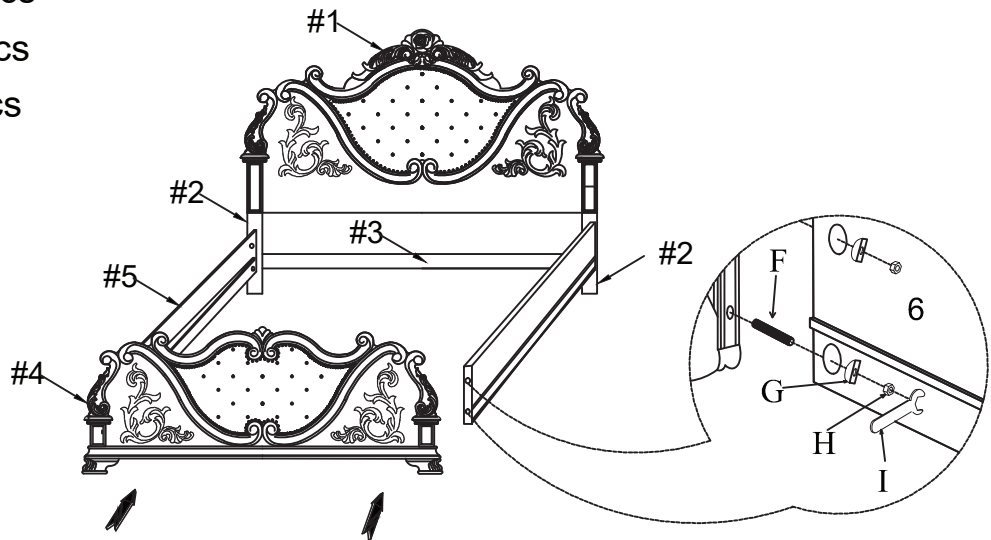

## 4

Part #6 x1pc

Part #7 x2pcs

Twist the Slat support leg(#7) onto the Slat (#6). Use levelers to adjust the height of the support leg.

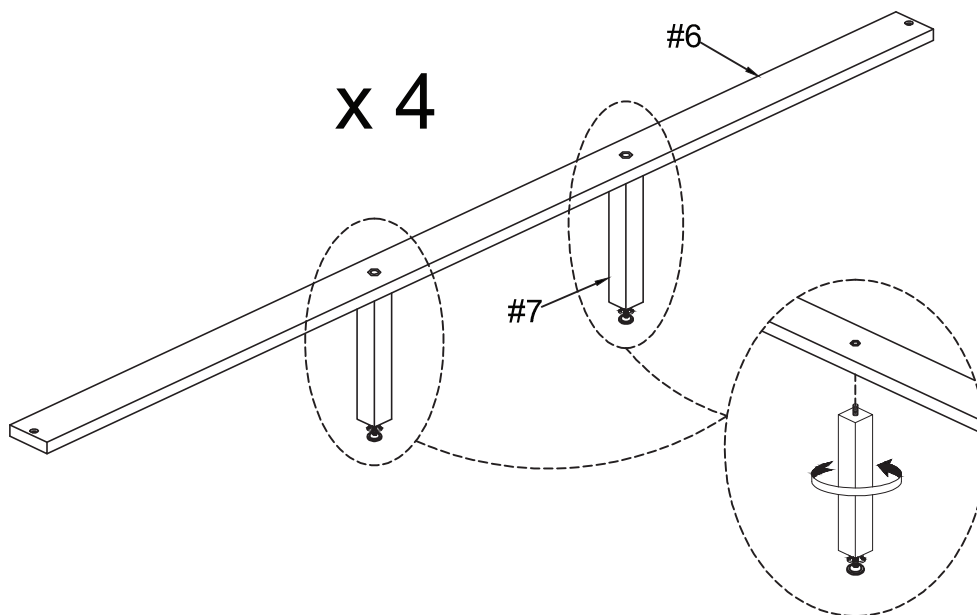

# ASSEMBLY INSTRUCTIONS

5

Hardware #E x8pcs

Align Slats (#6) with evenly within the frame and secure by using Screw (#E).

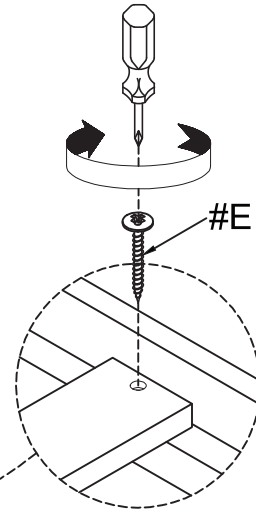
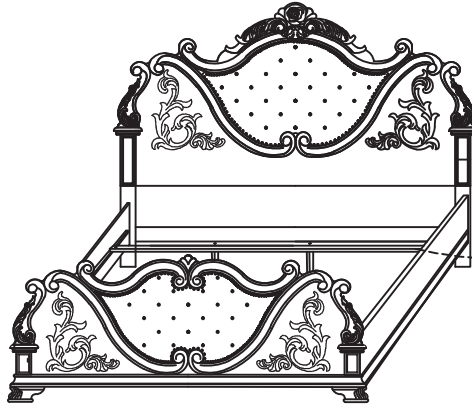

#5

6

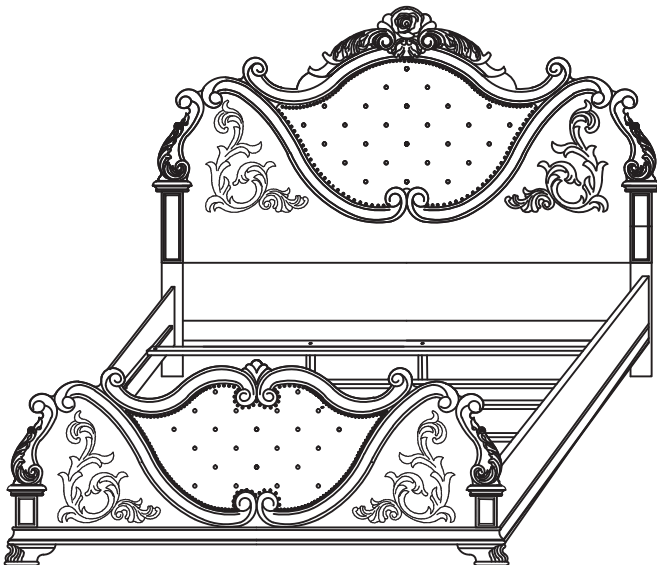

## ASSEMBLY COMPLETED



Please ensure the furniture rests on an even and flat surface. If the product wobbles or feels loose, double-check all bolts and/or screws are properly tightened and secured.

### ✓ Keep this handy!

Please retain this instruction manual and any order-related information for future reference.

### ✓ Lift, don't drag!

To avoid damage to product please always LIFT the product when transporting or adjusting the placement.

# ASSEMBLY INSTRUCTIONS



## TOOLS REQUIRED



2 - People Recommended

## ASSEMBLY RATING



EASY —————> DIFFICULT

The Assembly Rating is a 5-point system showing the level of effort needed to assemble a specific product.



## **CHECK BEFORE STARTING**

### **Are you missing anything?**

Double-check all parts, hardware and accessories listed are all accounted for.

### **Check out our Quick Tips!**

We recommend reviewing the pre-assembly handouts. Even experts need a refresher now and then!

### **Should we send any replacements?**

Are there any irregularities or flaws in the parts? We can send replacements!

### **Prep Time!**

Please review the assembly instructions and all diagrams prior to assembling.

# PRE ASSEMBLY INTRODUCTION

We understand building ready-to-assemble furniture can be a challenging experience for some. To help avoid confusion, we have provided some helpful tips that may speed up the process.

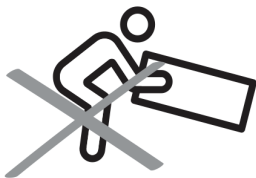

## Teamwork

ALWAYS have at least two people to help with transporting and assembling the product to avoid potential injury and/or damage.

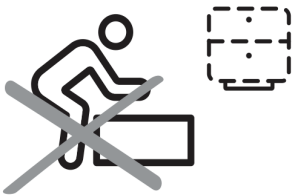

## Suitable Location

Assembling near the area of the intended location is highly recommended.



## Sufficient Space

Make sure you have enough space to move around during the assembly.



## Avoid Scratches

Use cardboard, blankets or a carpeted area while assembling furniture to prevent to prevent scratches and damages.



## Flat Surface

Make sure the furniture rests on a flat and level surface with each leg evenly touching the floor.

# ASSEMBLY AND CARE ADVICE



**FAILURE TO FOLLOW THE GUIDELINES BELOW MAY RESULT IN INJURY AND/OR PROPERTY DAMAGE.**



Position each part correctly and insert screws or bolts into their respective holes.

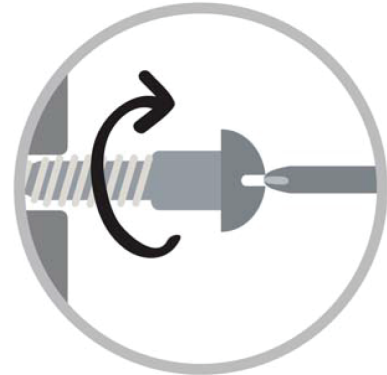

Turn clockwise to tighten and only tighten when step is completed or when instructed to do so.



Use the appropriate hand tools or power tools for assembly. Select steps, such as tightening screws and/or bolts, may require hand tools to avoid causing damage during assembly.



Save the instructions and store any supplied tools for later maintenance.



After two weeks, check and tighten any loose hardware and repeat again every six months thereafter.

**IT IS THE USER'S RESPONSIBILITY TO MAINTAIN THE FURNITURE. THE HARDWARE MAY LOOSEN OVER TIME AND MAY CAUSE THE FURNITURE TO BE WOBBLY AND UNABLE TO SUPPORT ITS INTENDED WEIGHT CAPACITY. THIS MAY LEAD TO COLLAPSE AND MAY CAUSE SERIOUS INJURY.**

# NIGHTSTAND

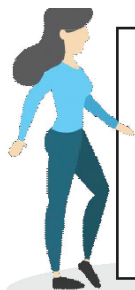

- Please keep instructions for future reference.
- Check the quantity and irregularity of parts and hardware before you start.



## PARTS

#1



Nightstand  
1pc

## HARDWARE

#A

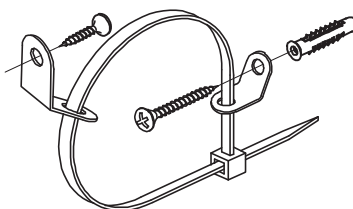

Anti Tip Kit  
1 Set

# ASSEMBLY INSTRUCTIONS

Use anti-tip kit to secure nightstand onto the wall.

1

Part #1 x1pc

Hardware #A X 1 Set

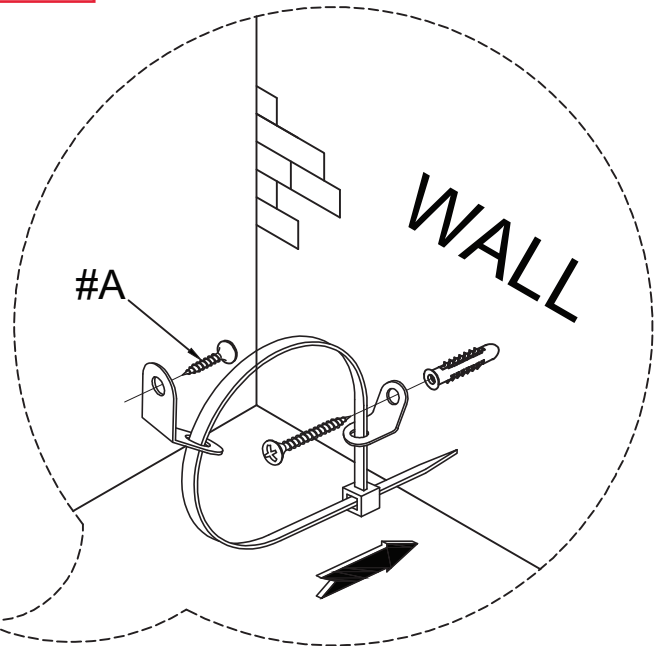

## ASSEMBLY COMPLETED



Please ensure the furniture rests on an even and flat surface. If the product wobbles or feels loose, double-check all bolts and/or screws are properly tightened and secured.

### ✓ Keep this handy!

Please retain this instruction manual and any order-related information for future reference.

### ✓ Lift, don't drag!

To avoid damage to product please always LIFT the product when transporting or adjusting the placement.

# ASSEMBLY INSTRUCTIONS

## Wall Mounting and Fixing



### EXPANSION WALL ANCHOR

Our provided expansion wall anchors are only suitable for masonry walls, such as drywall, plaster or concrete, and are best for holding lightweight items or for anti-tip prevention. If you are unsure of the correct wall anchor to use with the product, please request professional guidance. Liability for product damage or failure due to using the incorrect anchors will fall on the installer.



### CHECK BEFORE PROCEEDING

Prior to drilling or hammering, please check for wires or pipes. We recommend using a stud finder to locate a stud, which will offer more appropriate resistance and hold more weight.

## QUICK TIPS

1. If unsure of the proper size, always choose a larger screw and wall anchor.

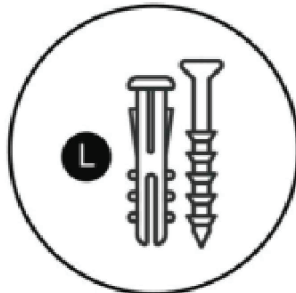

2. Match the drill bit to the wall anchor and hole size.

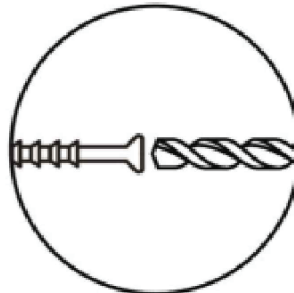

3. Only drill horizontally. Do not force the drill or enlarge the hole for the wall anchor.

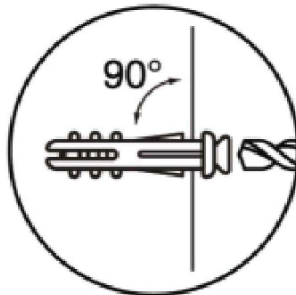

4. Take extra care when drilling into high walls or ceramic tiles. Wall anchors should be a tight fit for the hole. Never use wall anchors in ceilings.

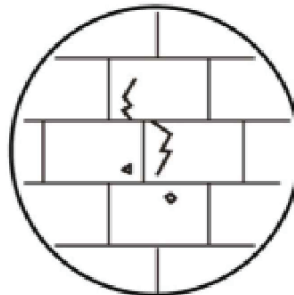

### MAINTENANCE



We recommend a yearly check to see if the wall anchor or screw has loosened. If so, please remove the existing wall anchor and screw, and use a new anchor.

# ASSEMBLY INSTRUCTIONS

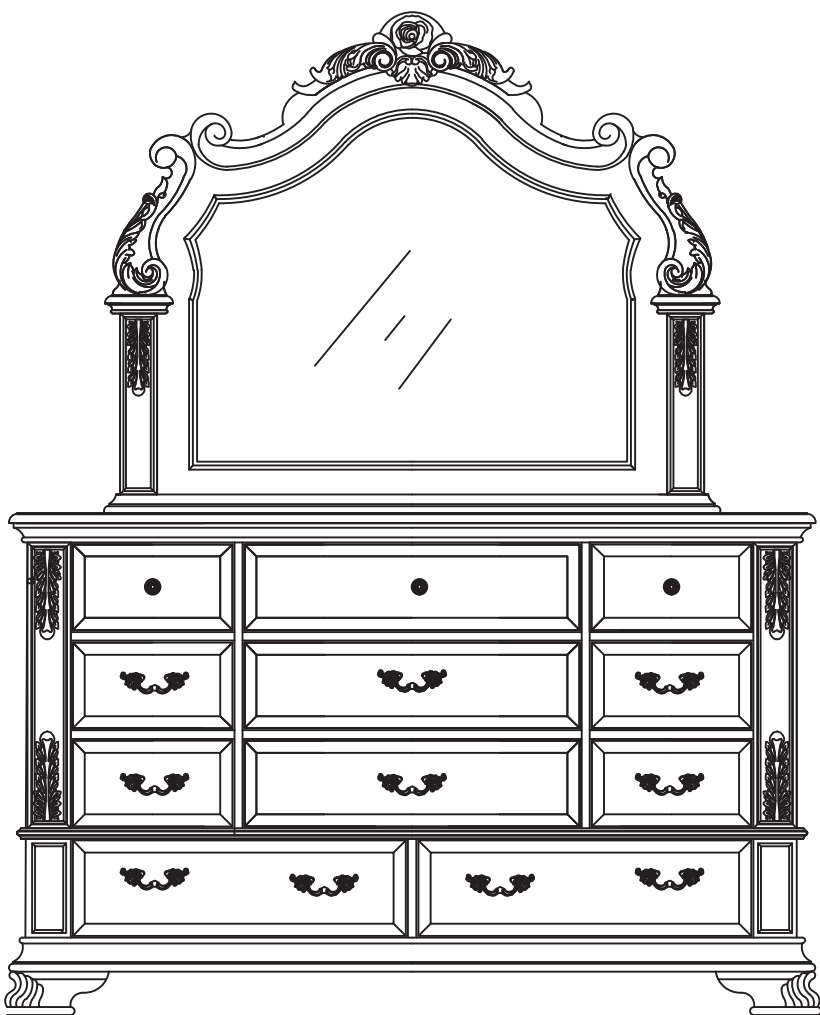

## TOOLS REQUIRED



Allen Wrench  
(Included)



Phillips  
Screwdriver  
(Not Included)



2 - People  
Recommended

## ASSEMBLY RATING



EASY —————> DIFFICULT

The Assembly Rating is a 5-point system showing the level of effort needed to assemble a specific product.



## **CHECK BEFORE STARTING**

### **Are you missing anything?**

Double-check all parts, hardware and accessories listed are all accounted for.

### **Check out our Quick Tips!**

We recommend reviewing the pre-assembly handouts. Even experts need a refresher now and then!

### **Should we send any replacements?**

Are there any irregularities or flaws in the parts? We can send replacements!

### **Prep Time!**

Please review the assembly instructions and all diagrams prior to assembling.

# PRE ASSEMBLY INTRODUCTION

We understand building ready-to-assemble furniture can be a challenging experience for some. To help avoid confusion, we have provided some helpful tips that may speed up the process.

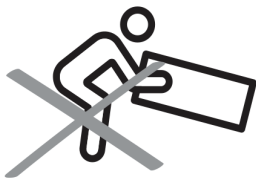

## Teamwork

ALWAYS have at least two people to help with transporting and assembling the product to avoid potential injury and/or damage.

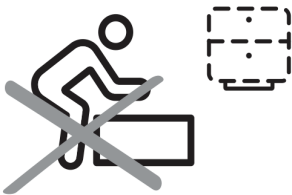

## Suitable Location

Assembling near the area of the intended location is highly recommended.



## Sufficient Space

Make sure you have enough space to move around during the assembly.



## Avoid Scratches

Use cardboard, blankets or a carpeted area while assembling furniture to prevent to prevent scratches and damages.



## Flat Surface

Make sure the furniture rests on a flat and level surface with each leg evenly touching the floor.

# ASSEMBLY AND CARE ADVICE



**FAILURE TO FOLLOW THE GUIDELINES BELOW MAY RESULT IN INJURY AND/OR PROPERTY DAMAGE.**



Position each part correctly and insert screws or bolts into their respective holes.

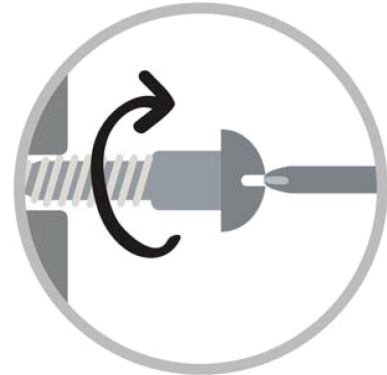

Turn clockwise to tighten and only tighten when step is completed or when instructed to do so.



Use the appropriate hand tools or power tools for assembly. Select steps, such as tightening screws and/or bolts, may require hand tools to avoid causing damage during assembly.



Save the instructions and store any supplied tools for later maintenance.



After two weeks, check and tighten any loose hardware and repeat again every six months thereafter.

**IT IS THE USER'S RESPONSIBILITY TO MAINTAIN THE FURNITURE. THE HARDWARE MAY LOOSEN OVER TIME AND MAY CAUSE THE FURNITURE TO BE WOBBLY AND UNABLE TO SUPPORT ITS INTENDED WEIGHT CAPACITY. THIS MAY LEAD TO COLLAPSE AND MAY CAUSE SERIOUS INJURY.**

# DRESSER & MIRROR

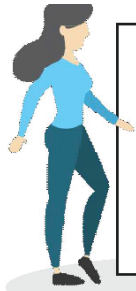

- Please keep instructions for future reference.
- Check the quantity and irregularity of parts and hardware before you start.

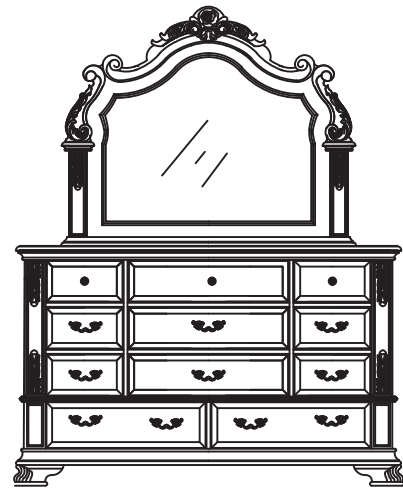

## PARTS

#1 1pc



Dresser

#2 1pc



Mirror

#3 2pcs



Mirror Support Rail

## HARDWARE

#A 8pcs



Bolt Ø5/16" x 1-1/2"

#B 8pcs



Lock Washer Ø5/16"

#C 8pcs

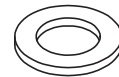

Flat Washer Ø5/16"

#D 1pc







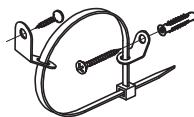



Allen Wrench M4

#E 1SET



Anti Tip Kit

# packed in 2 cases

Carton	Disignation	Part		Hardware
	Dresser	#1		
	Mirror	#2		 #A x8pcs  #B x8pcs  #C x8pcs  #D x1pc  #E x1SET
	Mirror Support Rail	#3		

# Exploded View

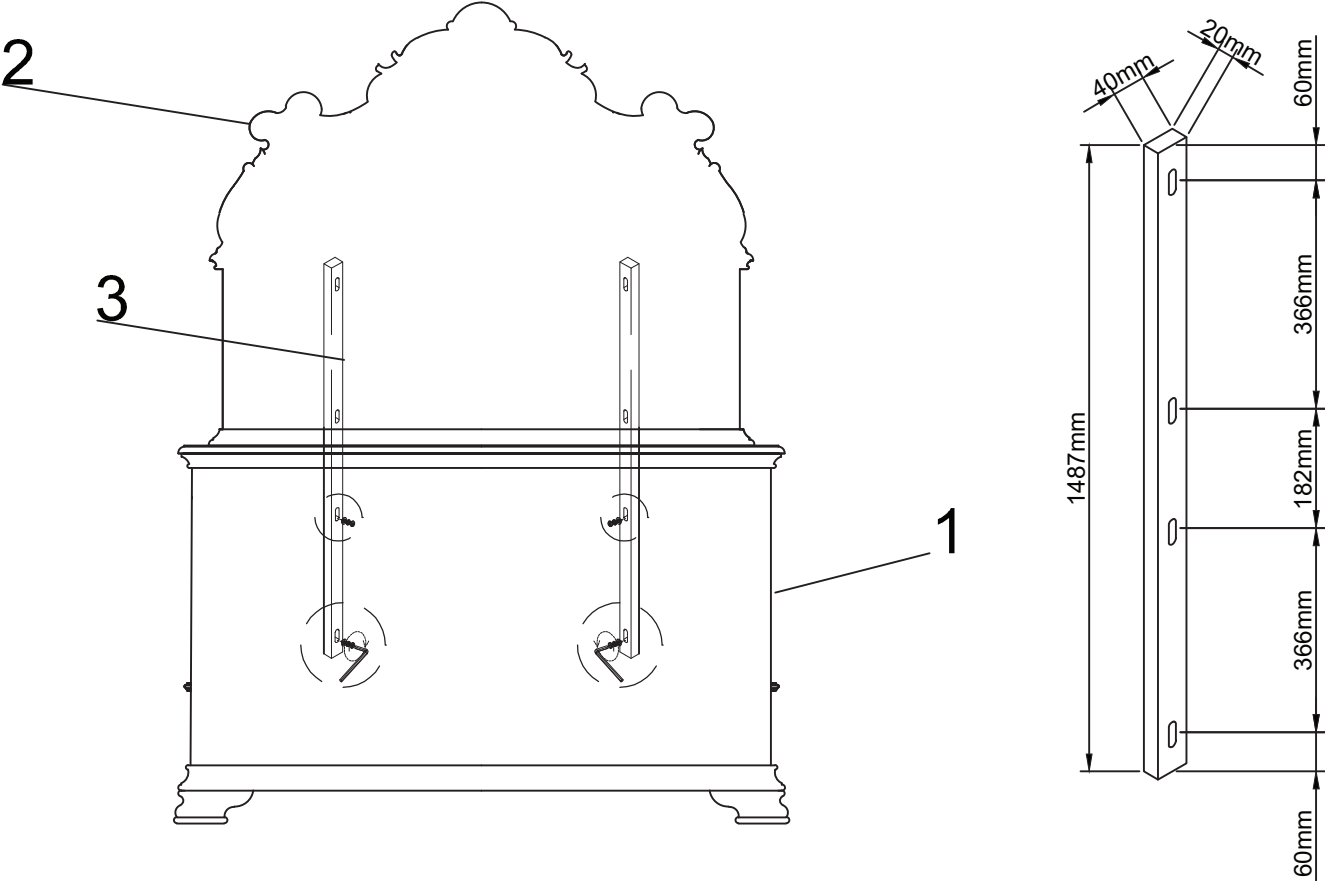

# ASSEMBLY INSTRUCTIONS

1



2

Align the Mirror support (#3) to the back of the dresser (#1). Secure by using Bolt (#A) with Lock washer (#B) and Flat washer (#C). Align the Mirror (#2) to the top of the Mirror support (#3) and secure by using Bolt (#A) with Lock washer (#B) and Flat washer (#C).

- Part #1 x1pc
- Part #2 x1pc
- Part #3 x2pcs
- Hardware #A x8pcs
- Hardware #B x8pcs
- Hardware #C x8pcs
- Hardware #D x1pcs

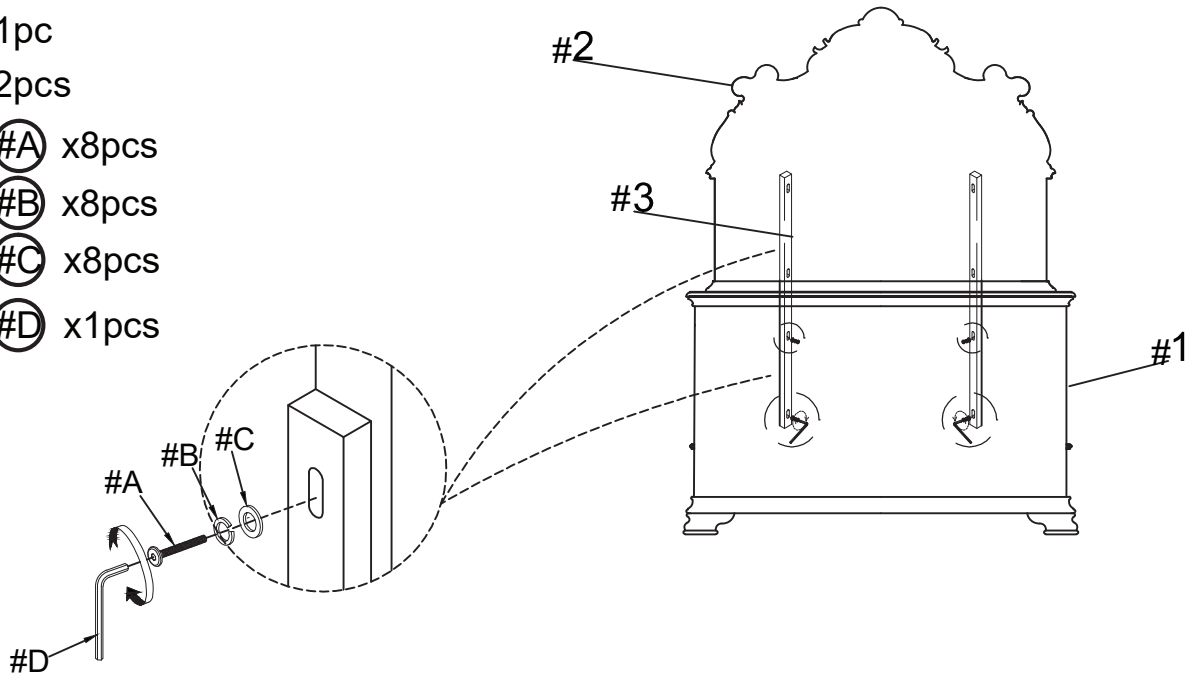

# ASSEMBLY INSTRUCTIONS

Use anti-tip kit to secure the top of the dresser onto the wall.

3

Hardware #E x1set

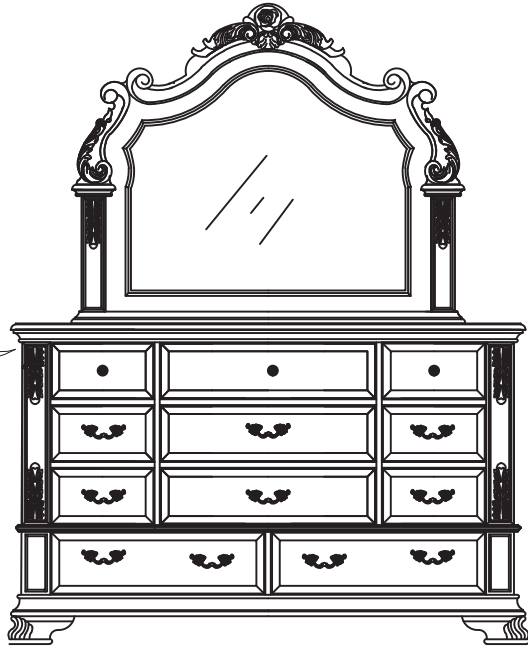
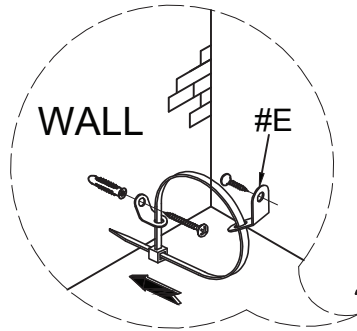

4

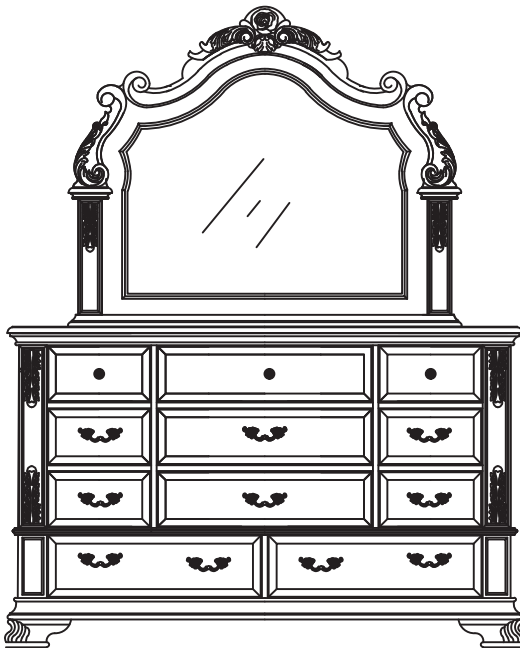

## ASSEMBLY COMPLETED



Please ensure the furniture rests on an even and flat surface. If the product wobbles or feels loose, double-check all bolts and/or screws are properly tightened and secured.

### ✓ Keep this handy!

Please retain this instruction manual and any order-related information for future reference.

### ✓ Lift, don't drag!

To avoid damage to product please always LIFT the product when transporting or adjusting the placement.

# ASSEMBLY INSTRUCTIONS

## Wall Mounting and Fixing



### EXPANSION WALL ANCHOR

Our provided expansion wall anchors are only suitable for masonry walls, such as drywall, plaster or concrete, and are best for holding lightweight items or for anti-tip prevention. If you are unsure of the correct wall anchor to use with the product, please request professional guidance. Liability for product damage or failure due to using the incorrect anchors will fall on the installer.

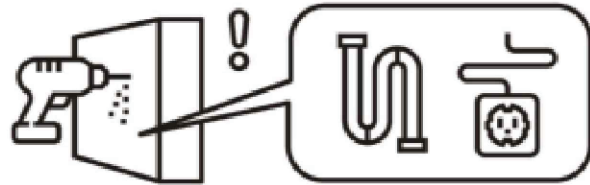

### CHECK BEFORE PROCEEDING

Prior to drilling or hammering, please check for wires or pipes. We recommend using a stud finder to locate a stud, which will offer more appropriate resistance and hold more weight.

## QUICK TIPS

1. If unsure of the proper size, always choose a larger screw and wall anchor.

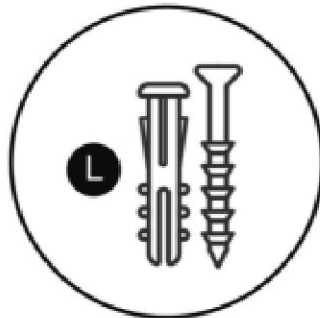

2. Match the drill bit to the wall anchor and hole size.

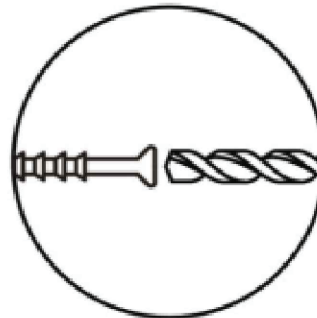

3. Only drill horizontally. Do not force the drill or enlarge the hole for the wall anchor.

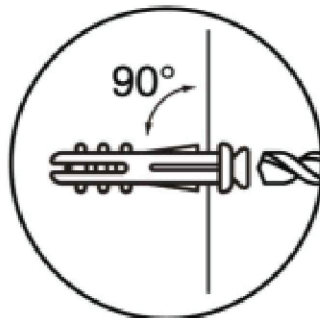

4. Take extra care when drilling into high walls or ceramic tiles. Wall anchors should be a tight fit for the hole. Never use wall anchors in ceilings.

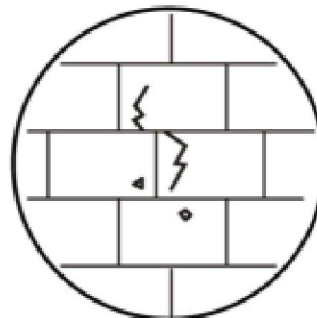

### MAINTENANCE



Yearly  
Check

We recommend a yearly check to see if the wall anchor or screw has loosened. If so, please remove the existing wall anchor and screw, and use a new anchor.