

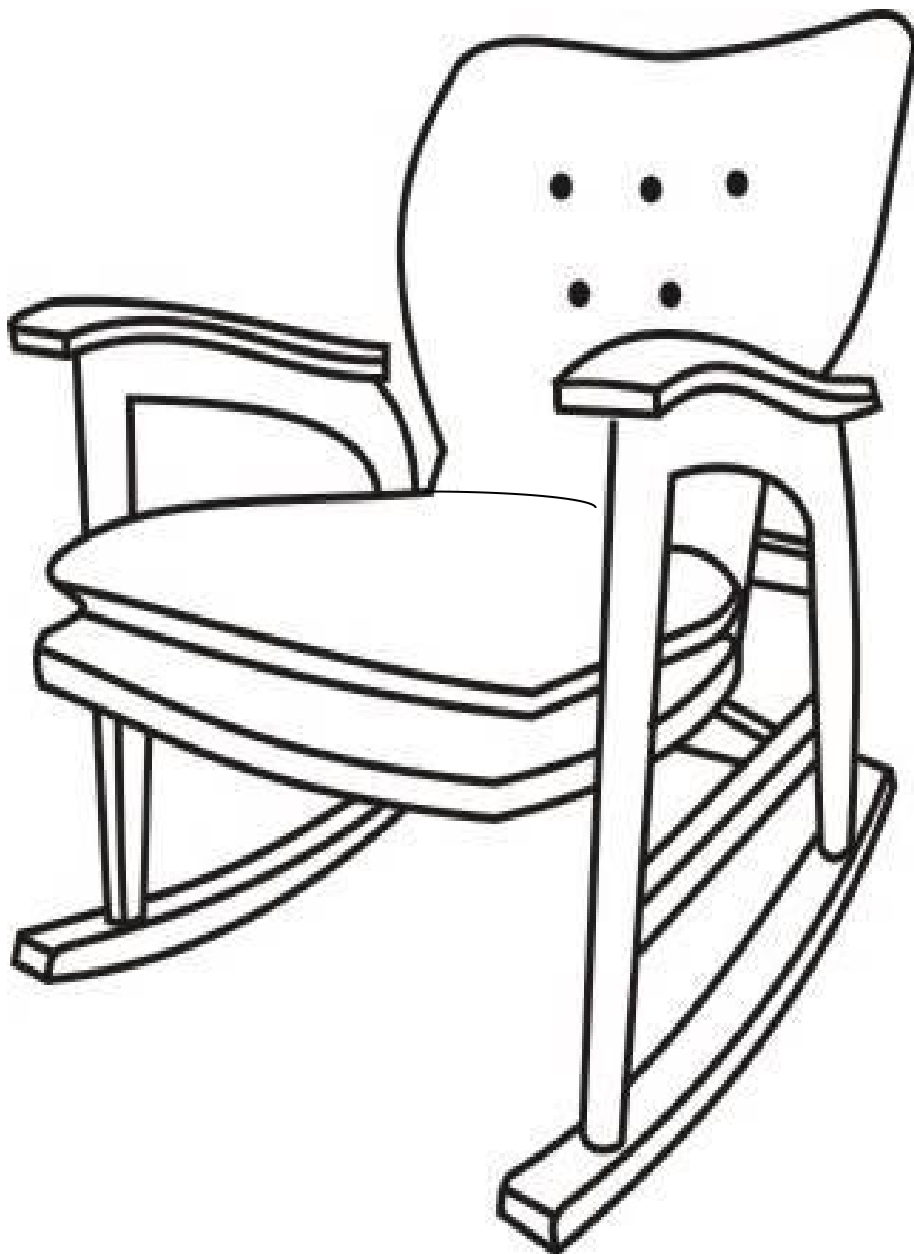



# Assembly Instructions

**Caution : You must read this before you proceed**

## ROCKING CHAIR

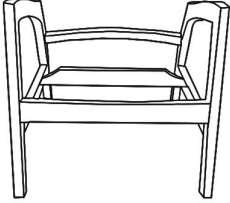
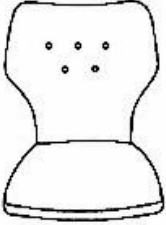
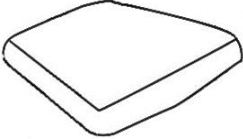



## Parts List

Label	Picture	Description	QTY
A		Frame	1
B		Seat	1
C		Cushion	1
D		Left Armrest	1
E		Right Armrest	1
F		Rocking Base	2

## Hardware

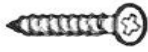
Label	Picture	Description	QTY
①		Bolt (M6*45MM)	5

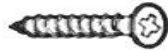
②		Screw (M4*40mm)	9
③		Allen Key	1
④		Screwdriver	1
⑤		Screw (M4*50mm)	3

## Assembly Preparation

Before Beginning Assembly :

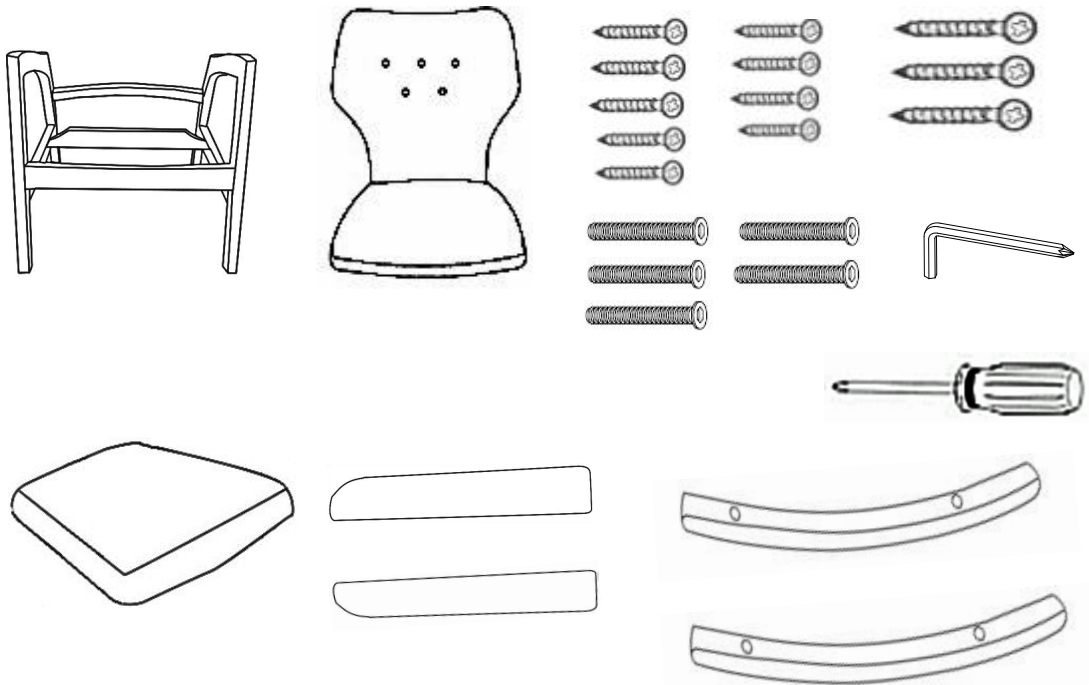

- Read instructions, cover to cover-



- Have 2 adults on hand for assembly-



- Do not assemble on flooring or carpet-



- Assemble on a clean non-marring surface (packing foam)-



- Save all packaging until finished-

# Assembly Steps

## Overview

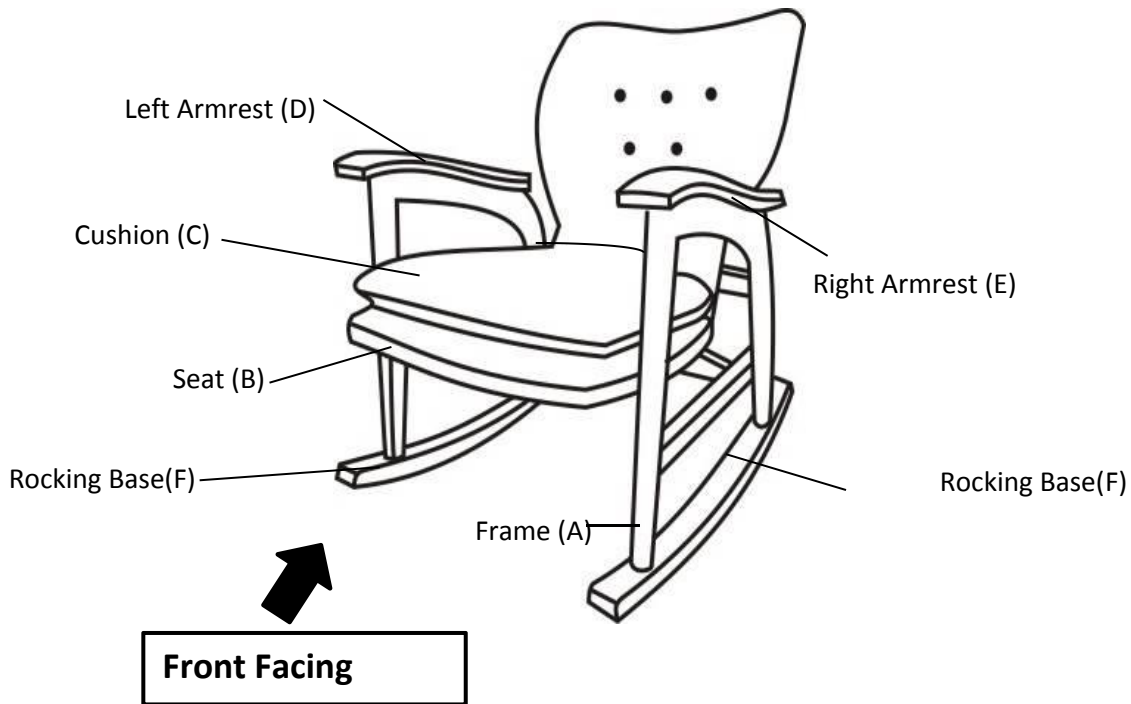

This Rocking Chair has multiple parts and may require up to 30 minutes to assemble. To give you an overview of the Rocking Chair parts, the above picture is to help you put the various parts into perspective. Please read through the instructions below to familiarise yourself with the parts and steps before assembly.

## Step 1

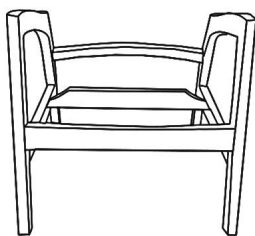

A

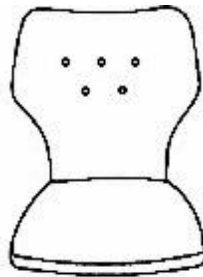

B

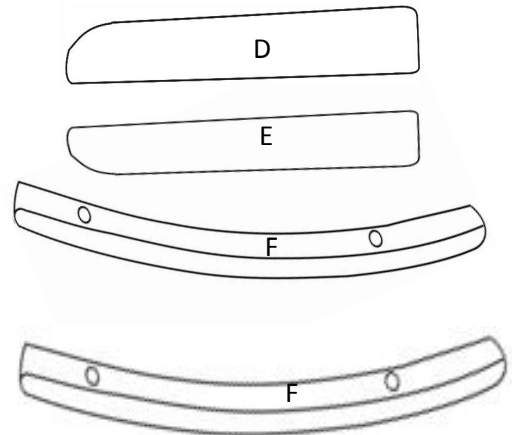

Place the Frame(A), Seat(B), Left Armrest(D), Right Armrest(E), Rocking Base(F) on a clean, non-marring surface.

Step 2

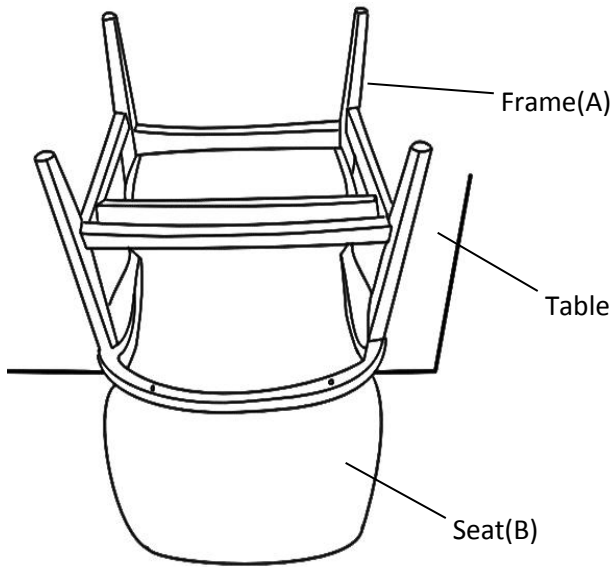

2.1

Seat(B) stuck in the middle of the Frame(A)

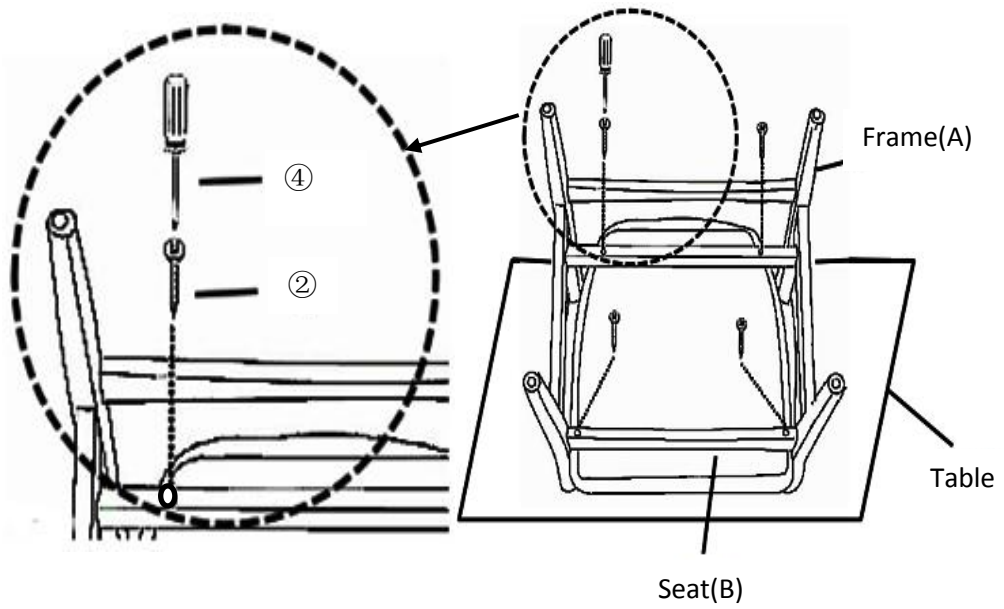

2.2

Place the Seat(B) on the side of a table, with the backrest facing down and perpendicular to the Desk Top.

**2.1)** Place the Frame(A) onto the Seat(B) with the Seat(B) stuck in the middle of the Frame(A) and align the mounting positions.

**2.2)** Attach Frame(A) to Seat(B) using Screws(②) with Screwdriver(④).

**Do not fully tighten the Screws.**

### Step 3

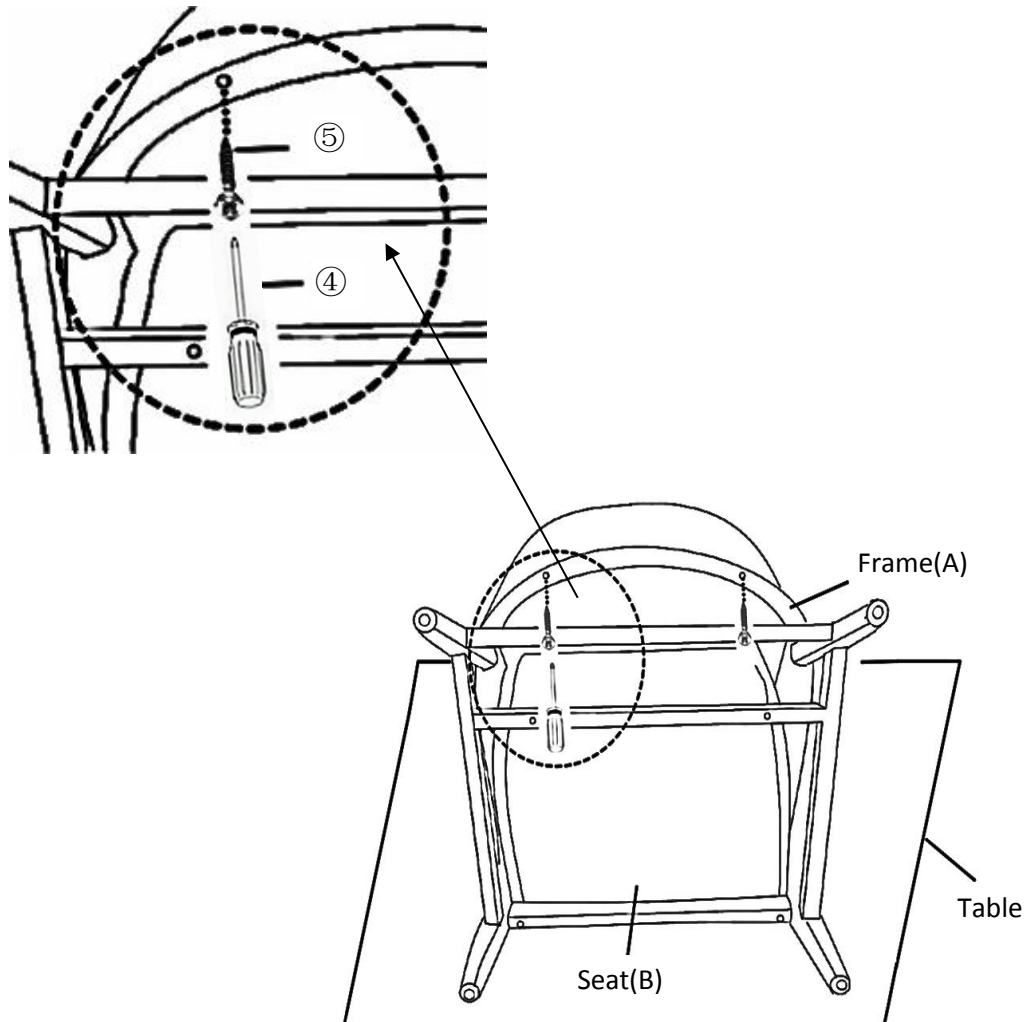

Attach Frame(A) to Seat(B) using Screws(⑤) with Screwdriver(④).

**Do not fully tighten the Screws.**

## Step 4

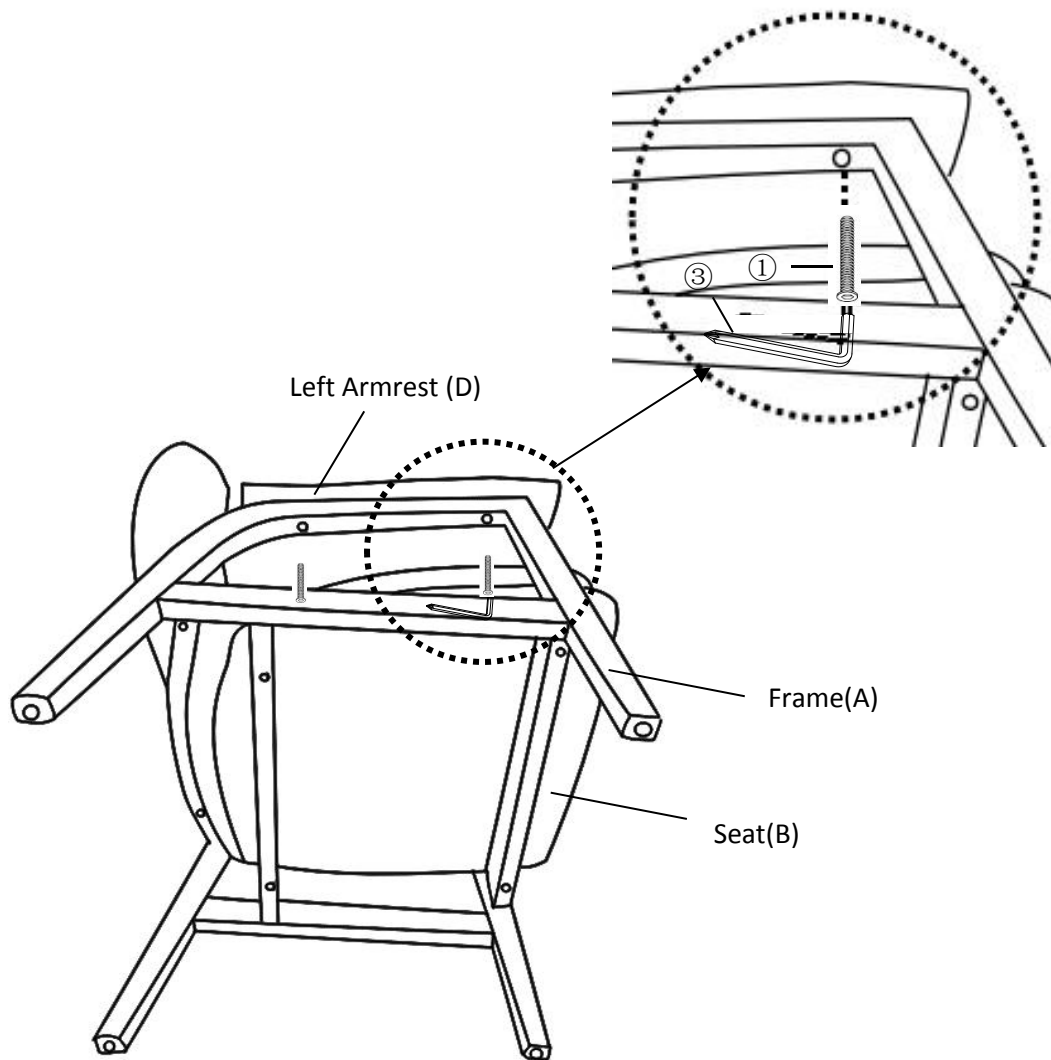

Place the Chair sideways on a clean, non-marring surface as shown above.

Align the mounting positions of the Left Armrest(D) with the Frame(A) and attach using Bolts(①) with Allen Key(③).

**Do not fully tighten the Bolts.**

Repeat this process with the Right Armrest(E).

**Note: If the mounting positions cannot be aligned well and hinder the installation, then sway the Armrest lightly when locking the Bolts; this action could help prevent the Bolts from getting stuck and ensure smooth assembly.**

## Step 5

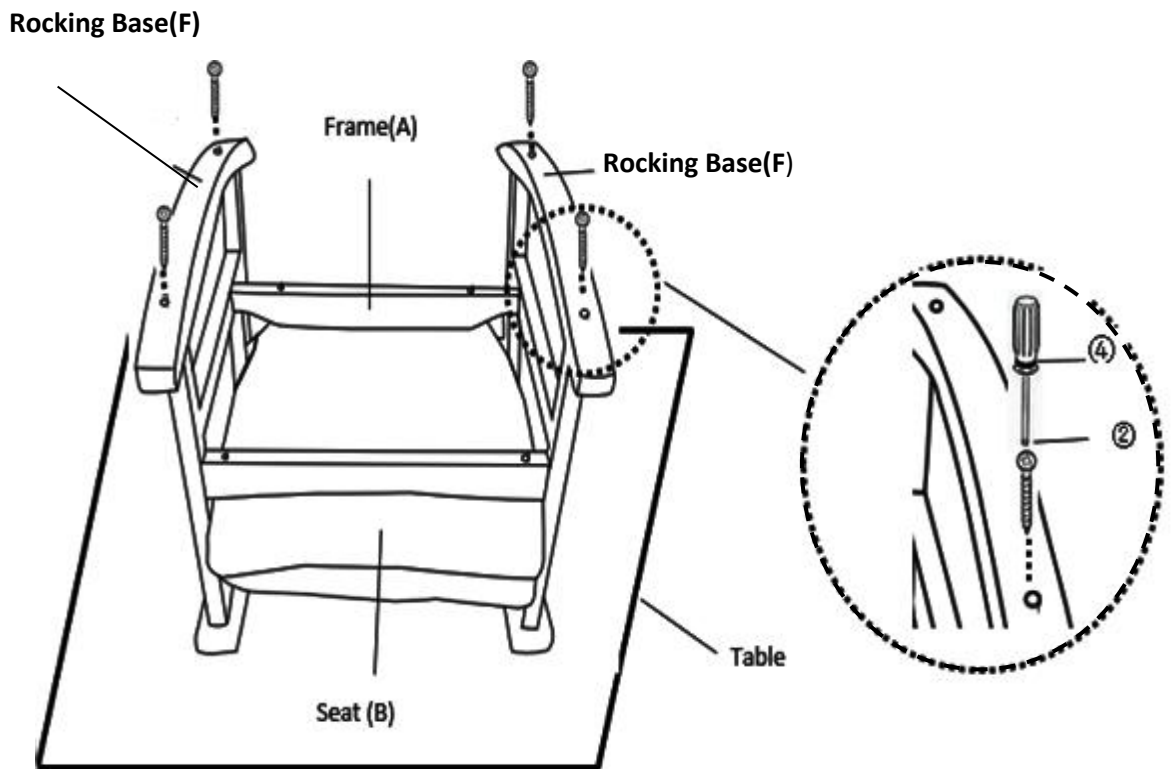

Position the assembled Chair on the edge of a Table as pictured. Align the mounting positions of the Rocking Base(F) with the Frame(A) and attach using Screws(②) with Screwdriver(④).

**Do not fully tighten the Screws.**

**Note: There are two mounting sites on the Rocking Base, please insert the back foot into the back mounting position first and then do the same for the front foot, this action should ensure smoother assembly.**

## Step 6

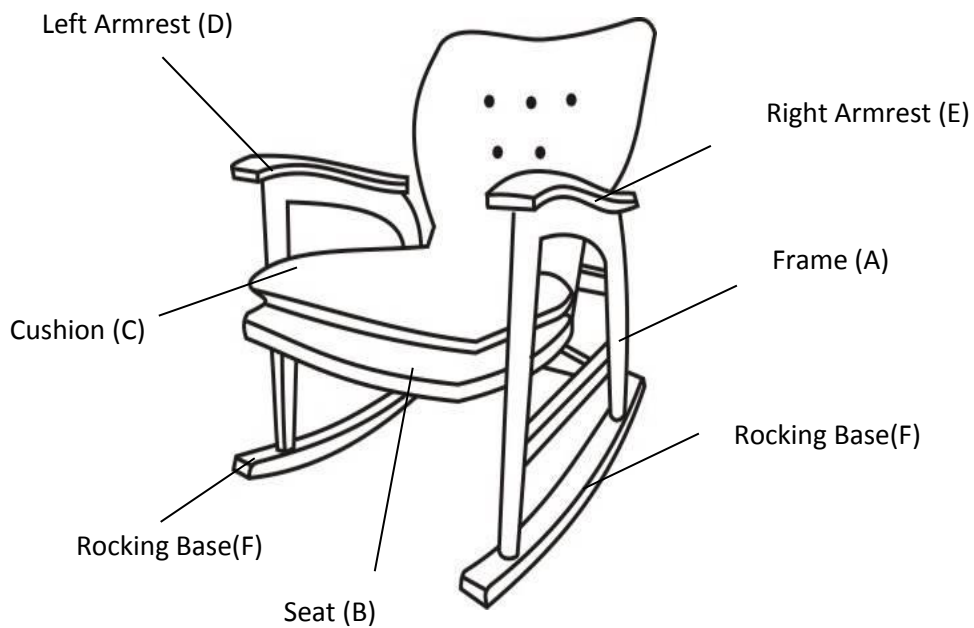

### **Test for Stability**

Inspect the Rocking Chair and make sure all parts are adequately connected.

**Gently and carefully, sit into to the Rocking Chair.**

This would help to align all the parts at all joints.

Then get off the Rocking Chair, and place it facedown.

**Proceed to tighten all Bolts and Screws at all joints in a sequential manner.**

**If there are still wobbles, loosen the Bolts and Screws and execute this same process.**

Finally, stand the Rocking Chair right side up, and put the Cushion(C) on the Seat(B) as shown in the picture.



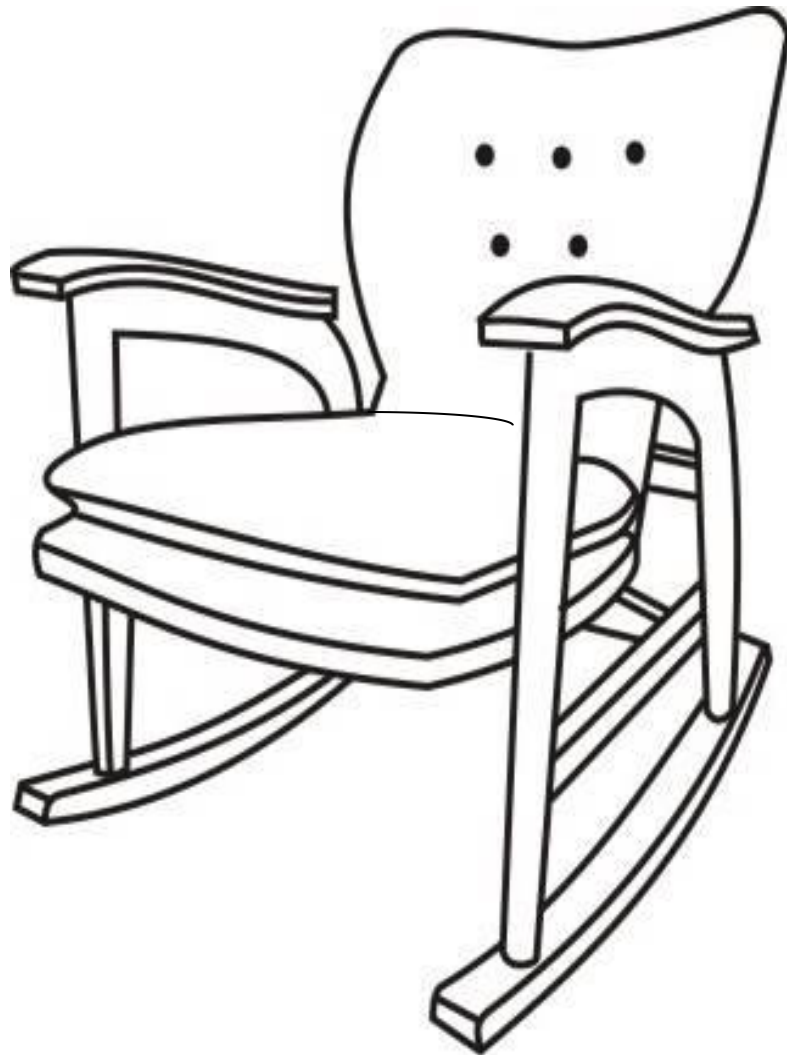

















Step 7



Your Rocking Chair is ready for use.

**This Rocking Chair can only be used on a flat, level surface.**

## Care & Maintenance

-   • Do not put hot items directly on furniture surface
  -   • Do not clean furniture with harsh cleansers or polish.
  -   • Do not place furniture under direct sunlight.
  -   • Do not place furniture near heating or cooling vents.
  -   • Do not write on furniture without a padded barrier to protect the surface.
  -   • Do not place furniture outside . For indoor use only .
  -   • Not for commercial use. For residential use only .
  -   • Stains may be removed with mild soap solution and damp cloth.
  -   • Children should not climb or jump on the furniture.
- 
-   • Dust and pick-up spills using a clean, non-colored, lint-free cloth .