

15

INSTALLATION STEPS

Adjust Height 高さを調節

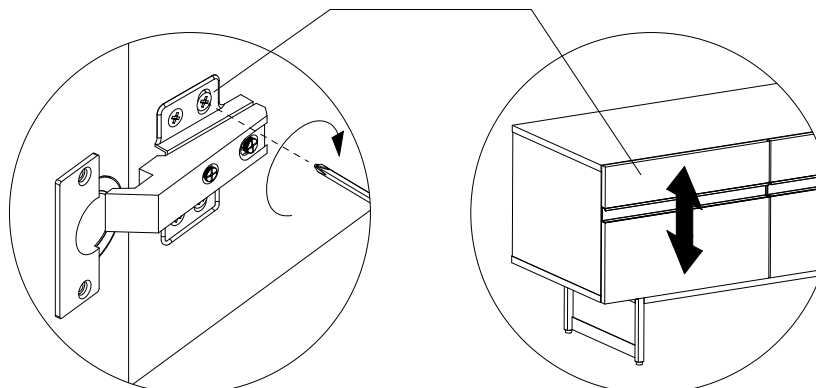

Adjust front and back 前後を調節

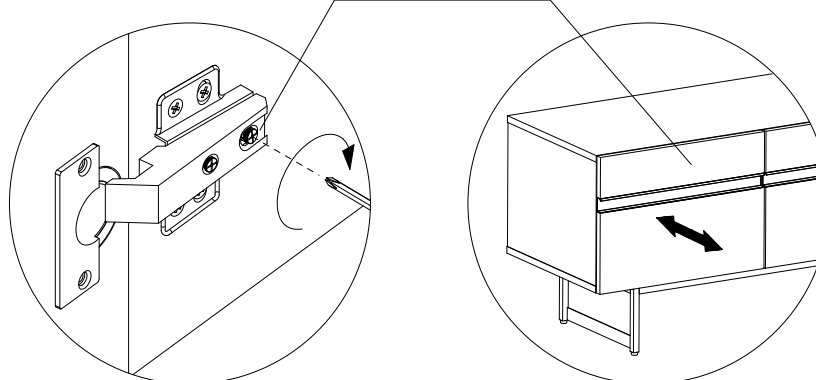

Adjust left and right 左右を調節

