

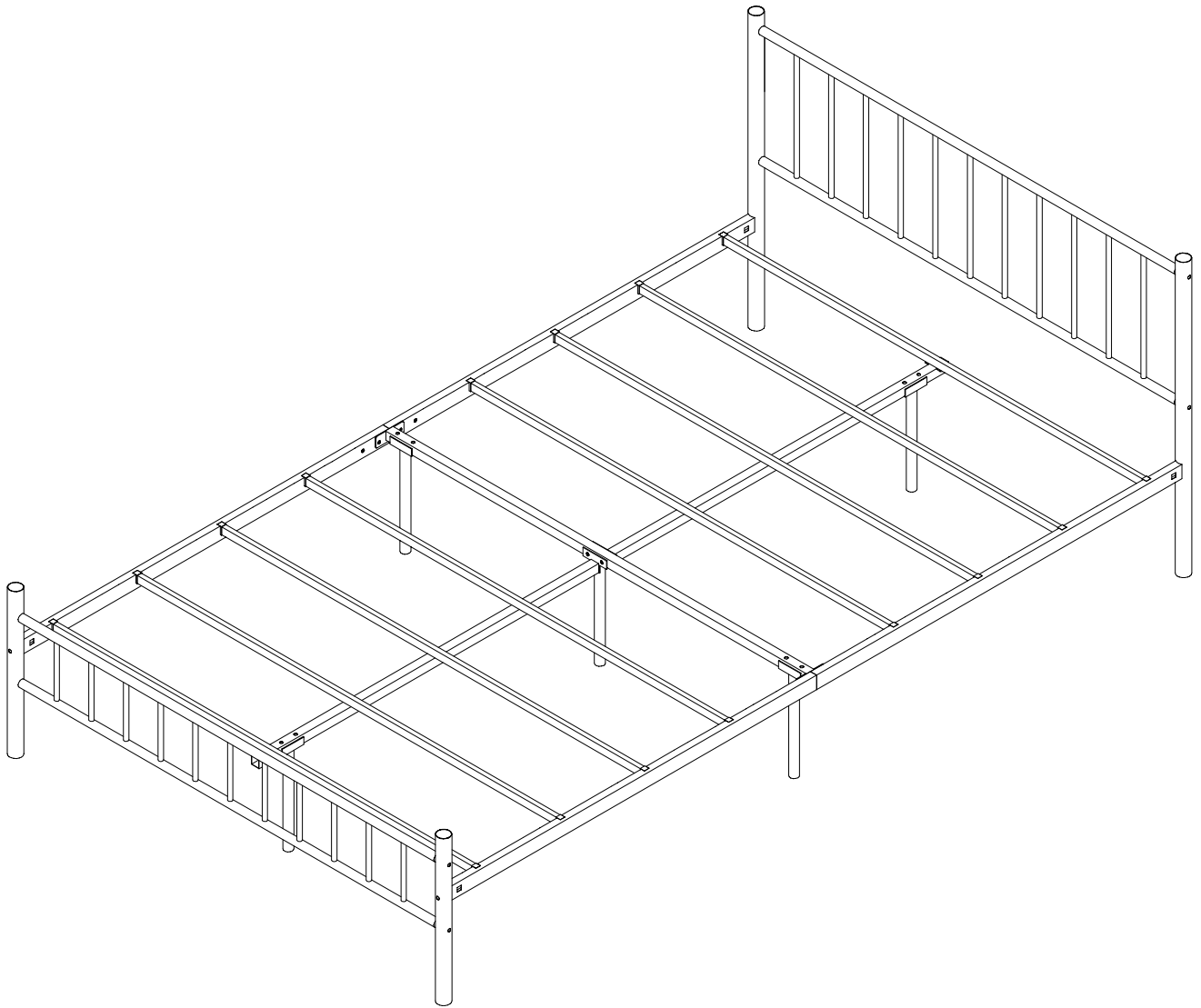

















KESSIE DOUBLE/FULL

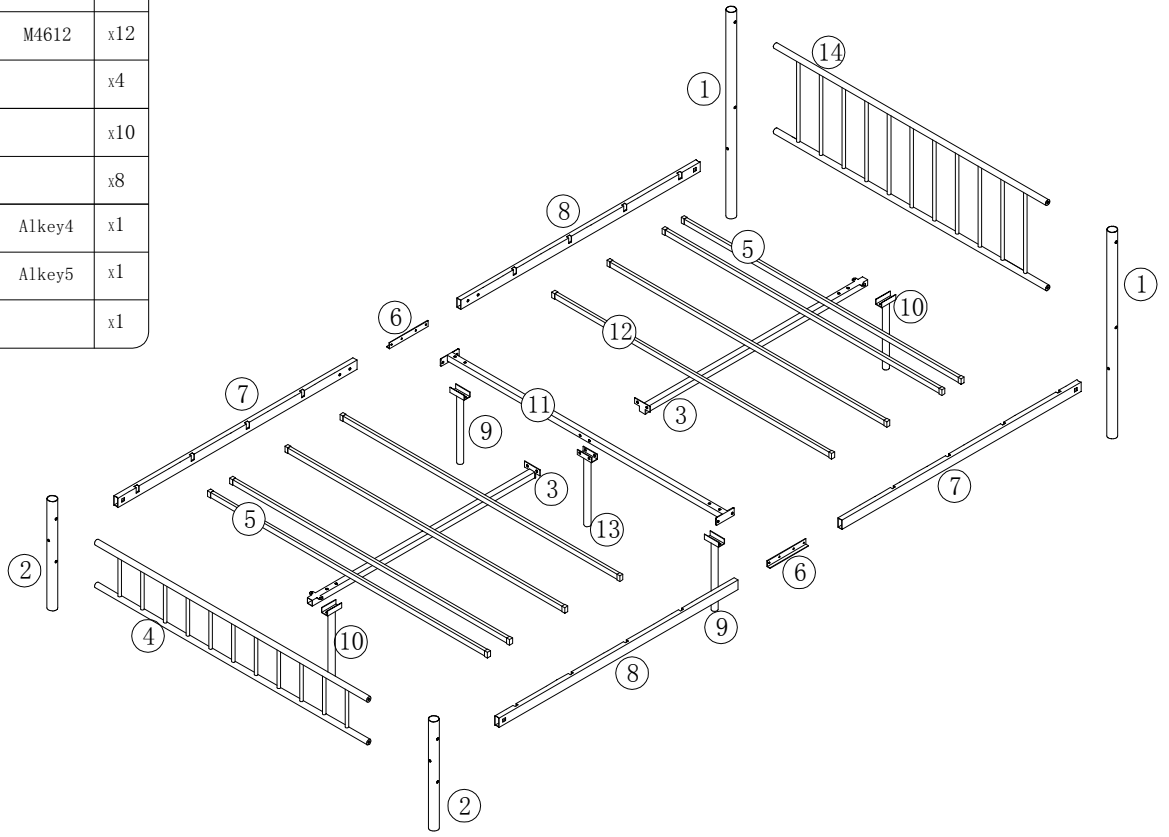
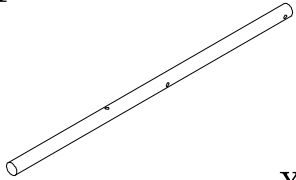
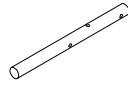
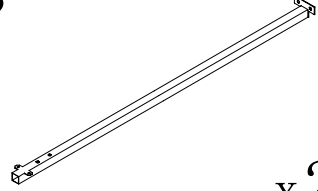
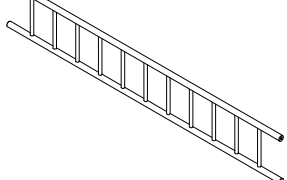
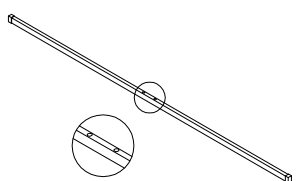

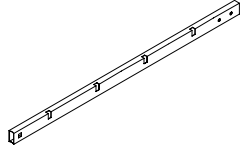
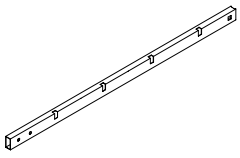
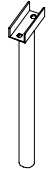
A		M6x45mm	M4645	x10
B		M8x70mm	M5880	x4
C		Φ8.5		x12
D		M6x35mm	M4635	x8
E		M6x12mm	M4612	x12
F				x4
G		M6		x10
H		Φ7		x8
I			Alkey4	x1
J			Alkey5	x1
K				x1

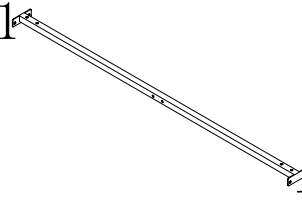
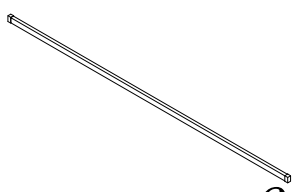

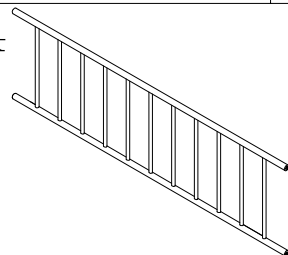
1  x2	2  x2	3  x2	4  x1
5  x2	6  x2	7  x2	8  x2
9  x2	10  x2	11  x1	12  x6
13  x1	14  x1		

STEP 1

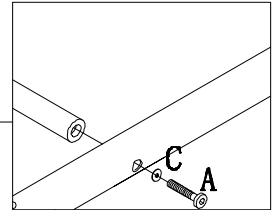
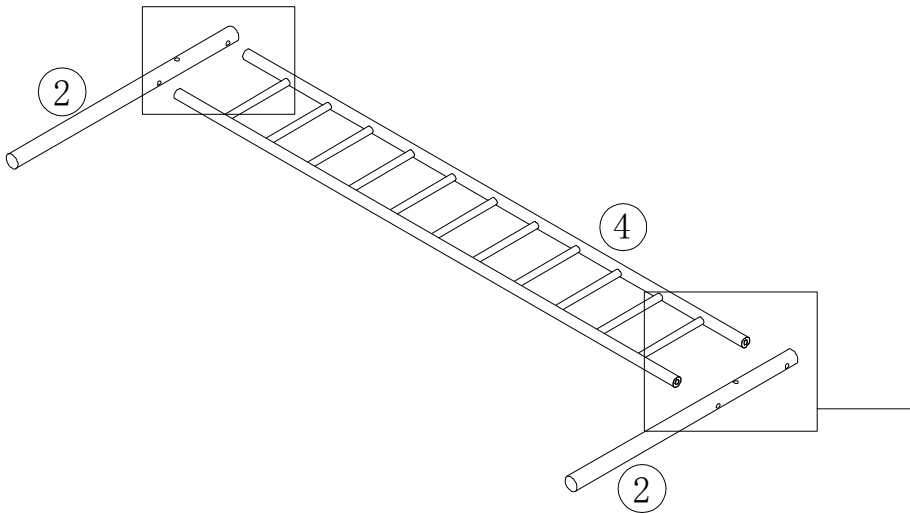
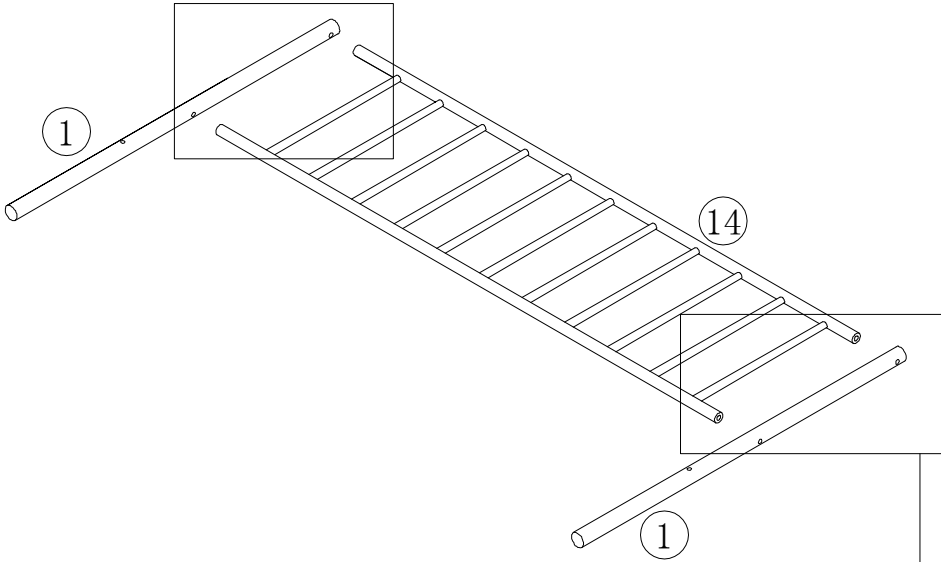
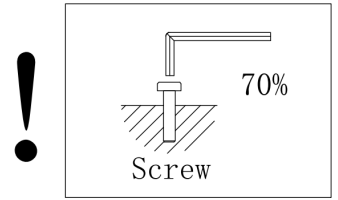

A		x8
C		x8

STEP 2

Please separate the parts 7 and 8 before beginning the assembly.

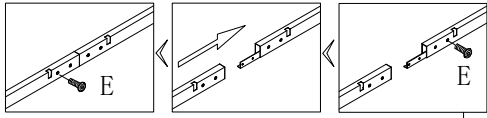
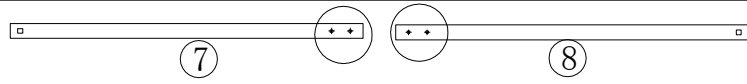

E		X2
---	--	----

The small piece #6 goes inside the two longer piece 7 and 8.

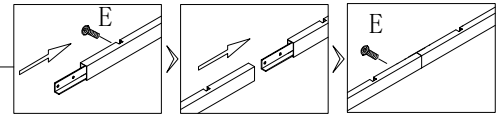
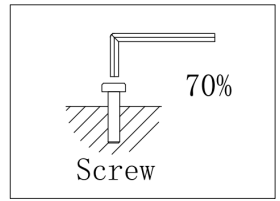
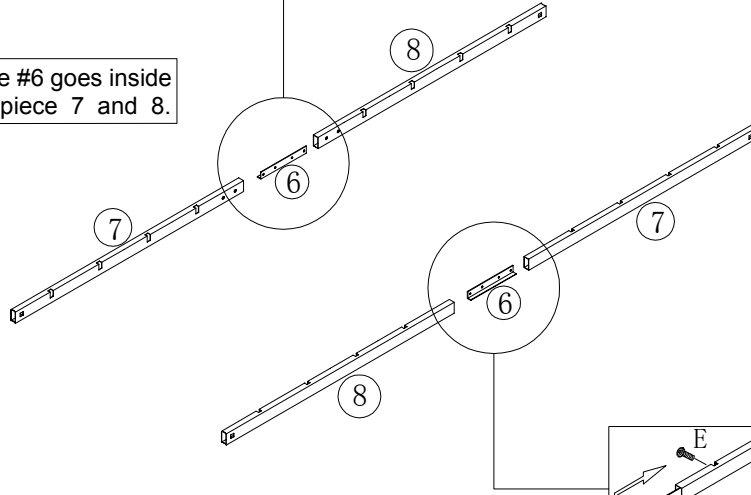

E		X2
---	--	----

STEP 3

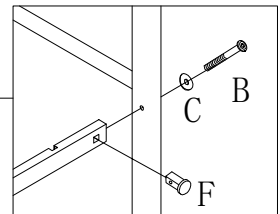
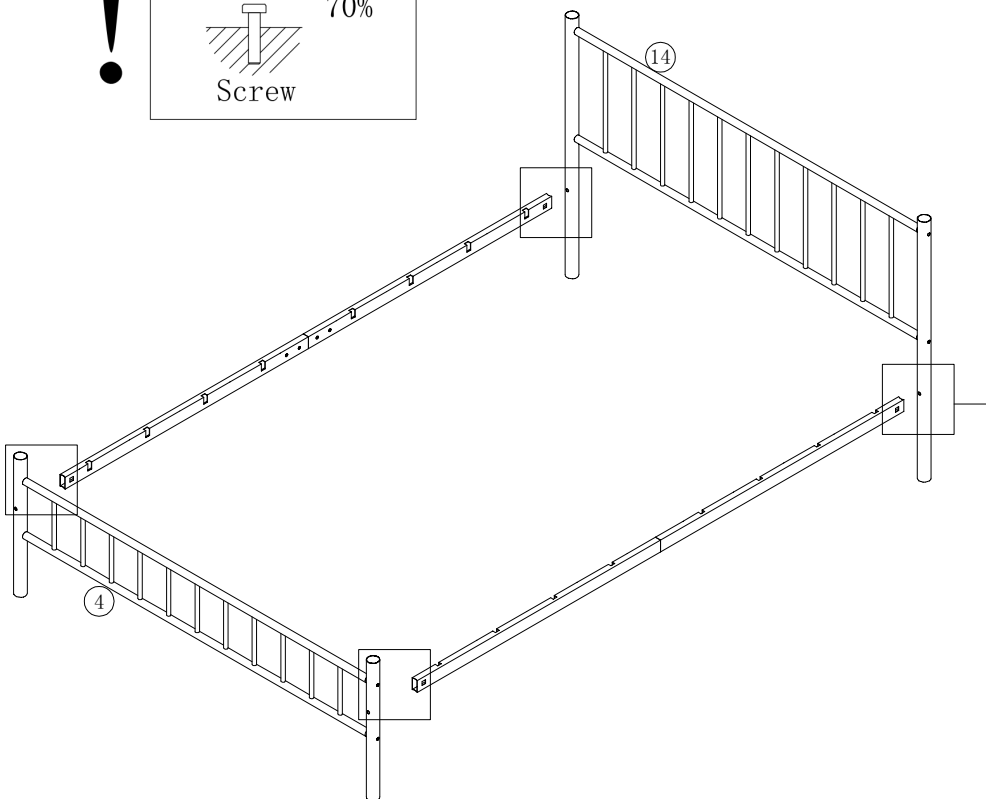
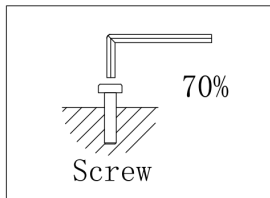

B		X4
F		X4
C		X4

STEP 4

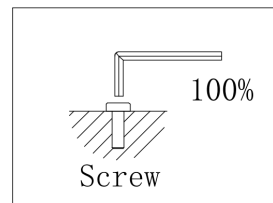
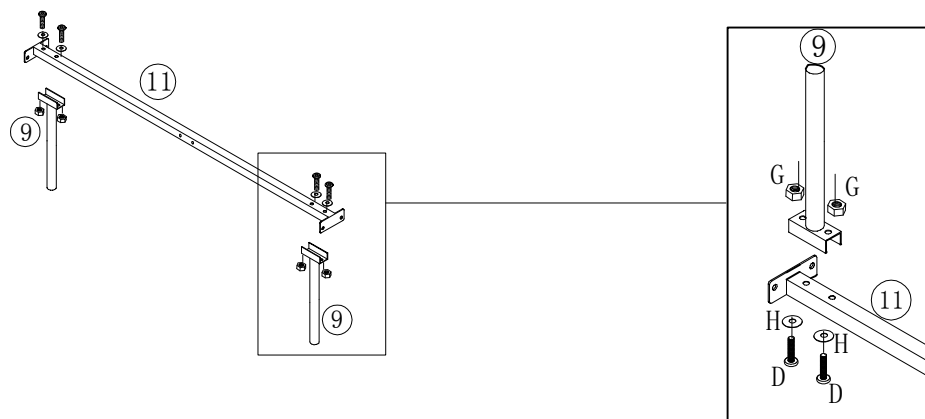

D		X4
H		X4
G		X4

STEP 5

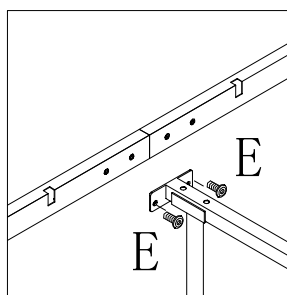

E		X4
---	--	----

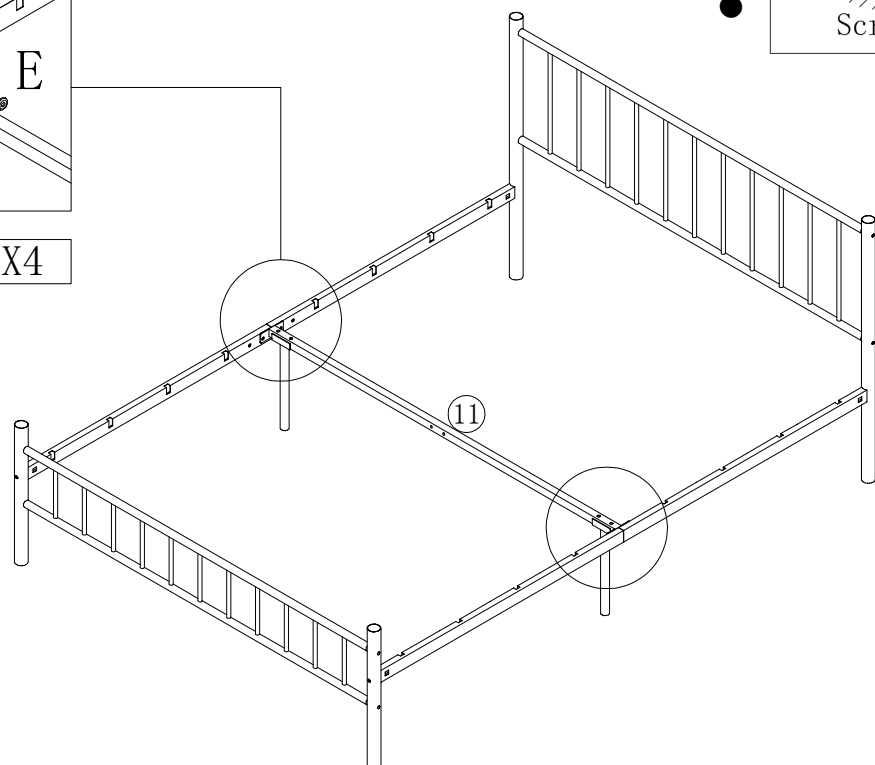
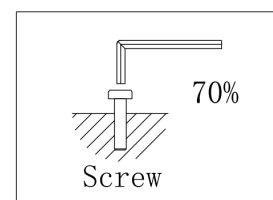

STEP 6

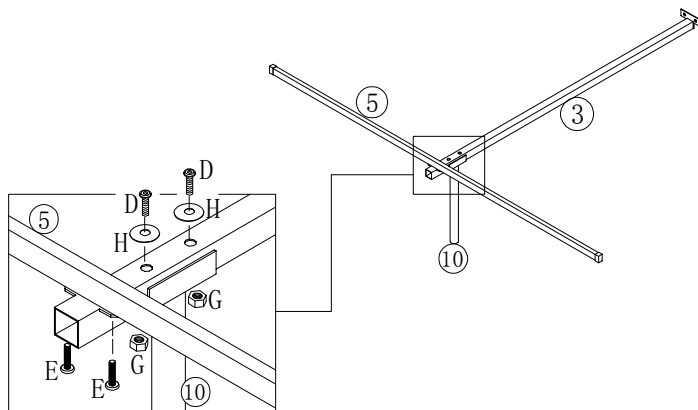
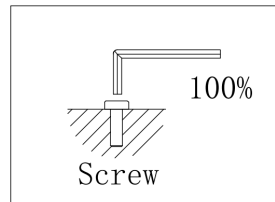

D		X4
H		X4
E		X4
G		X4

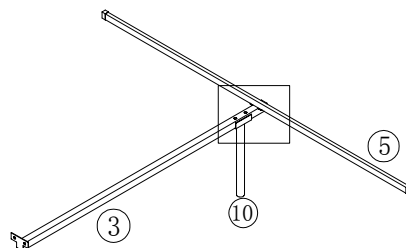

STEP 7

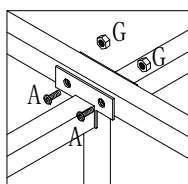
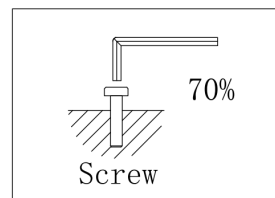

A		X2
G		X2

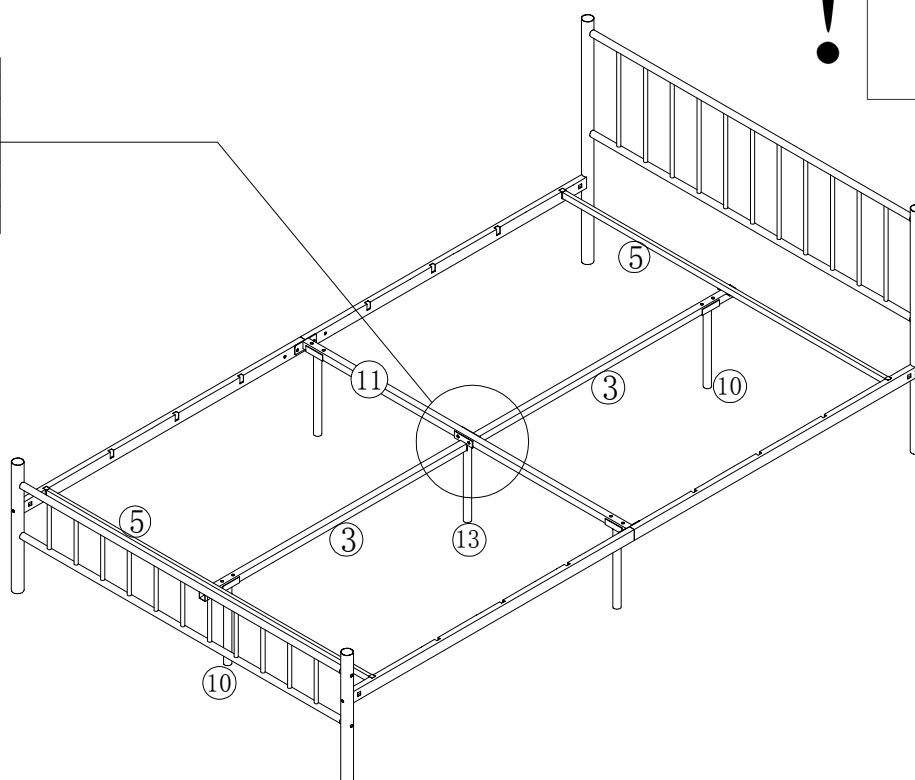

STEP 8

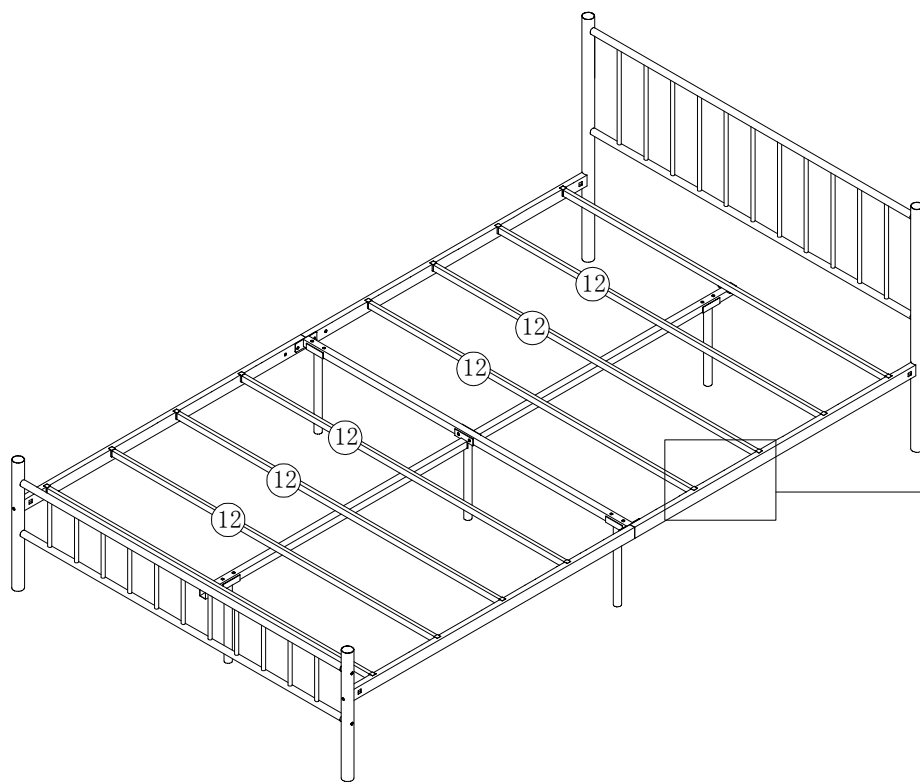

Please confirm that the buckle is installed in place

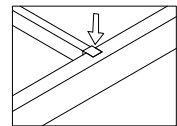
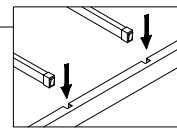
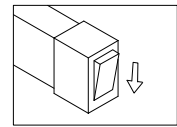
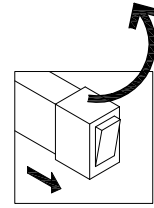

STEP 9

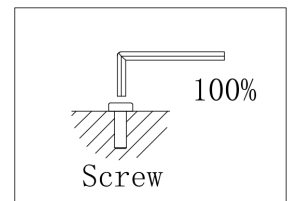
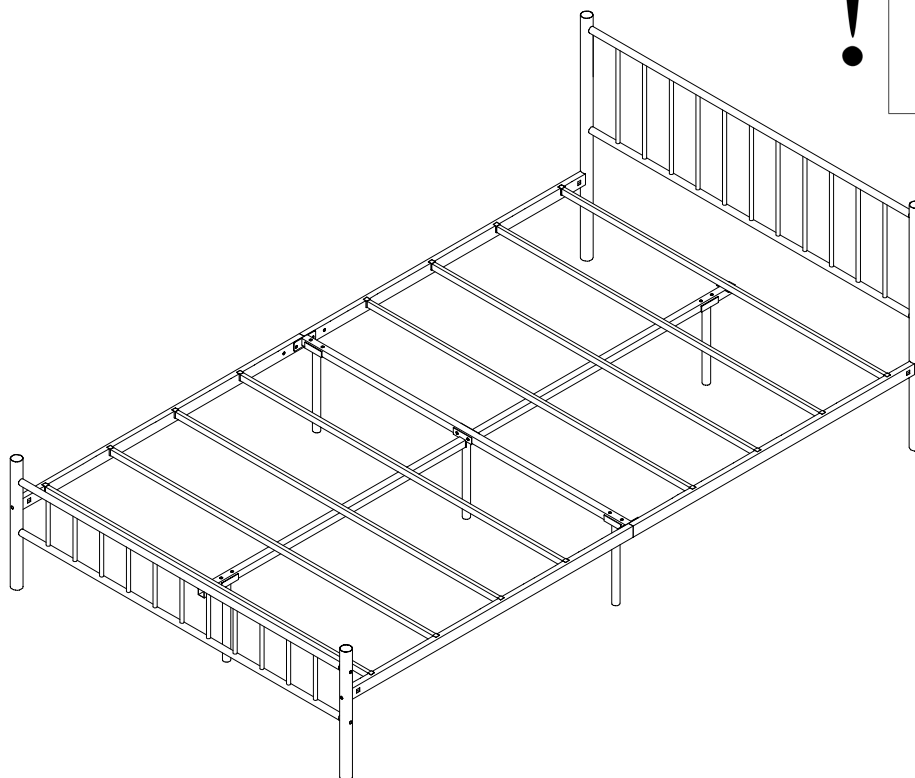

IMPORTANT – READ CAREFULLY – RETAIN FOR FUTURE REFERENCE
Wichtig - Bitte sorgfältig lesen - Reserviert für zukünftige Referenz
IMPORTANT - À LIRE ATTENTIVEMENT - À CONSERVER POUR
RÉFÉRENCE ULTÉRIEURE
IMPORTANTE - LEA CUIDADOSAMENTE - CONSERVE PARA
REFERENCIA FUTURA
IMPORTANTE - LEGGERE ATTENTAMENTE - PRENOTARE PER
FUTURO RIFERIMENTO

WARNING : Children must stay away from the assembly zone, preventing children from potential asphyxia because of plastic bag and foam breathing in nose.

WARNUNG: Kinder müssen sich vom Montagebereich fernhalten, um das Ersticken von Kindern durch Plastiktüten und Nasenschaum zu verhindern.

AVERTISSEMENT : Les enfants doivent rester à l'écart de la zone de montage, évitant ainsi aux enfants une asphyxie potentielle à cause du sac en plastique ou de la mousse.

ADVERTENCIA: Los niños deben mantenerse alejados de la zona de reunión, evitando que puedan asfixiarse debido a la bolsa de plástico y la espuma que respiran por la nariz;

AVVERTENZA: i bambini devono stare lontano dalla zona di assemblaggio, impedendo ai bambini la possibilità di asfissia a causa del sacchetto di plastica e della schiuma che respira nel naso;

WARNING : Do not stand on the product for any purpose.

Warnung: Stellen Sie sich auf keinen Fall auf das Produkt.

AVERTISSEMENT: Ne vous tenez pas sur le produit pour quelque raison que ce soit.

ADVERTENCIA: No se pare sobre el producto por ningún motivo

AVVERTENZA: non salire sul prodotto per nessuno scopo.

WARNING : For your safety, please do not tread or climb product.

Warnung: Steigen Sie aus Sicherheitsgründen nicht auf das Produkt

AVERTISSEMENT : Pour votre sécurité, veuillez à ne pas marcher ni grimper le produit.

ADVERTENCIA: Por su seguridad, no pise ni suba el producto.

AVVERTENZA: per motivi di sicurezza, non calpestare o scalare il prodotto.

WARNING : The loading weight of seating shall be within the range that vendor claims.

WARNUNG: Das Ladegewicht des Sitzes sollte innerhalb des vom Lieferanten angegebenen Bereichs liegen.

AVERTISSEMENT : Le poids de chargement du mobilier doit être compris dans la plage indiquée par le fournisseur.

ADVERTENCIA: El peso de carga de los asientos debe estar dentro del rango que el vendedor reclama

AVVERTENZA: il peso di carico dei posti a sedere deve rientrare nell'intervallo richiesto dal venditore

WARNING : The product is designed for adults use, domestic use and indoor use only.

Warnung: Dieses Produkt ist nur für Erwachsene, für den Heimgebrauch und für den Innengebrauch bestimmt.

AVERTISSEMENT : Le produit est conçu pour un usage adulte, domestique et intérieur uniquement.

ADVERTENCIA: El producto está diseñado para uso de adultos, uso doméstico y uso en interiores solamente.

AVVERTENZA: il prodotto è progettato esclusivamente per uso domestico, domestico e interno.

WARNING : Check regularly that all assembly fastenings are properly tightened, do not use the product if any structural part is broken or missing

WARNUNG: Überprüfen Sie regelmäßig alle Befestigungselemente der Komponenten auf festen Sitz. Verwenden Sie dieses Produkt nicht, wenn strukturelle Komponenten beschädigt sind oder fehlen.

AVERTISSEMENT : Vérifiez régulièrement que toutes les fixations de l'assemblage sont correctement serrées. N'utilisez pas le produit si une pièce de la structure est cassée ou manquante.

ADVERTENCIA: Verifique regularmente que todos los sujetadores de ensamblaje estén apretados adecuadamente, no use el producto si alguna parte estructural está rota o falta.

AVVERTENZA: verificare regolarmente che tutti i fissaggi di assemblaggio siano serrati correttamente, non utilizzare il prodotto se una parte strutturale è rotta o mancante.

WARNING : Incorrect installation and incorrect use can cause accidents. Please completely follow the guidance of assembly instruction.

WARNUNG: Unsachgemäße Installation und unsachgemäße Verwendung können zu Unfällen führen. Bitte folgen Sie den Anweisungen in der Montageanleitung vollständig.

AVERTISSEMENT: Une installation incorrecte et une utilisation incorrecte peuvent provoquer des accidents. S'il vous plaît suivez complètement les instructions de montage.

ADVERTENCIA: La instalación incorrecta y el uso incorrecto pueden causar accidentes. Siga por completo la guía de instrucciones de montaje.

ATTENZIONE: un'errata installazione e un uso errato possono causare incidenti. Seguire completamente la guida delle istruzioni di montaggio

Security instructions

Before assembling check whether all parts listed in the parts list have been delivered. Do not start assembling if parts are missing or damaged.

A failure to assemble this product correctly could cause damage or result in serious injury!

Before assembling make sure that you have enough space for the procedure.

Assemble on a flat surface.

Keep the assembly instructions available at all times and follow each of the individual steps exactly.

During assembly, be careful with all the parts of the assembly (do not walk on them or distort them) and beware of shearing and trapping risks. Keep children and pets away while setting up the furniture.

Sicherheitshinweise

Überprüfen Sie vor dem Zusammenbau, ob alle in der Teileliste aufgeführten Teile geliefert wurden. Beginnen Sie nicht mit der Montage, wenn das Teil fehlt oder beschädigt ist.

Wenn dieses Produkt nicht ordnungsgemäß zusammengebaut wird, kann es beschädigt oder schwer verletzt werden!

Stellen Sie vor dem Zusammenbau sicher, dass genügend Platz für den Betrieb vorhanden ist.

Auf einer ebenen Fläche montiert.

Halten Sie die Montageanleitung immer bereit und befolgen Sie jeden Schritt genau.

Achten Sie beim Zusammenbau auf alle Teile der Baugruppe (nicht gehen oder verdrehen) und achten Sie auf die Gefahr des Abscherens und Einklemmens. Bei der Installation von Möbeln von Kindern und Haustieren fernhalten.

Instructions de sécurité

Avant de procéder au montage, vérifiez si toutes les pièces répertoriées dans la liste de pièces ont été livrées.

Un assemblage incorrect de ce produit pourrait causer des dommages ou des blessures graves!

Avant de procéder au montage, assurez-vous de disposer de suffisamment d'espace pour la procédure.

Assemblez sur une surface plane.

Conservez les instructions de montage et suivez chacune des étapes à la lettre.

Pendant l'assemblage, faites attention à toutes les pièces de l'assemblage (ne marchez pas dessus, ne les déformez pas) et prenez garde aux risques de cisaillement et de coincement. Éloignez les enfants et les animaux domestiques lors du montage des meubles.

Instrucciones de seguridad

Antes de armar, verifique si se han entregado todas las piezas enumeradas en la lista de piezas. No comience a armar si faltan piezas o están dañadas.

¡Si no ensambla este producto correctamente podría causar daños o lesiones graves!

Antes de armar, asegúrese de tener suficiente espacio para el procedimiento.

Montar sobre una superficie plana.

Mantenga las instrucciones de montaje disponibles en todo momento y siga cada uno de los pasos individuales exactamente.

Durante el ensamblaje, tenga cuidado con todas las partes del ensamblaje (no camine sobre ellas ni las distorsione) y tenga cuidado con los riesgos de corte y atrapamiento.

Mantenga alejados a los niños y las mascotas mientras coloca los muebles.

Istruzioni di sicurezza

Prima del montaggio, verificare se tutte le parti elencate nell'elenco delle parti sono state consegnate. Non iniziare il montaggio in caso di parti mancanti o danneggiate.

Un mancato assemblaggio corretto di questo prodotto può causare danni o lesioni gravi!

Prima di assemblare assicurarsi di avere abbastanza spazio per la procedura.

Montare su una superficie piana.

Mantenere sempre disponibili le istruzioni di montaggio e seguire esattamente ciascuna delle singole fasi.

Durante il montaggio, prestare attenzione a tutte le parti del gruppo (non calpestarle o deformarle) e fare attenzione ai rischi di taglio e intrappolamento. Tenere lontani bambini e animali domestici durante l'installazione dei mobili.