

Pure & Easy



ASSEMBLY INSTRUCTIONS

NOTICE

IMPORTANT, RETAIN FOR FUTURE REFERENCE: READ CAREFULLY
WICHTIG, FÜR SPÄTERE NACHSCHLAGE AUFBEWAHREN: SORGFÄLTIG LESEN
IMPORTANTE, GUARDAR PARA REFERENCIA FUTURA: LEER ATENTAMENTE
IMPORTANTE, CONSERVARE PER RIFERIMENTI FUTURI: LEGGERE ATTENTAMENTE
IMPORTANT, À CONSERVER POUR RÉFÉRENCE FUTURE : LIRE ATTENTIVEMENT

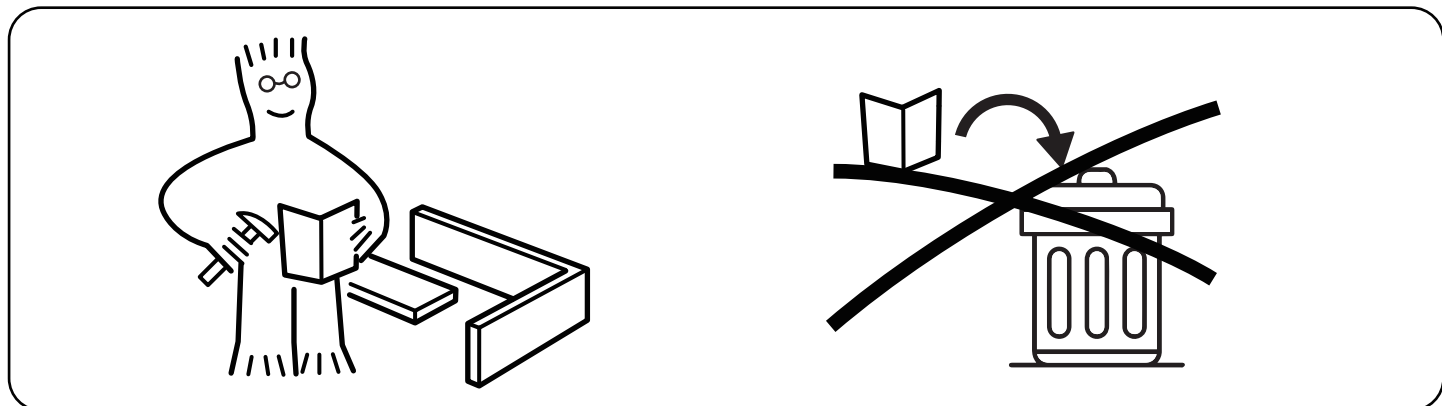

Assemble on a flat, clean and soft surface.
Auf einer flachen, sauberen und weichen Oberfläche zusammenbauen.
Assembler sur une surface plate, propre et douce.
Assemblare su una superficie piatta, pulita e morbida.
Ensamblar sobre una superficie plana, limpia y suave.

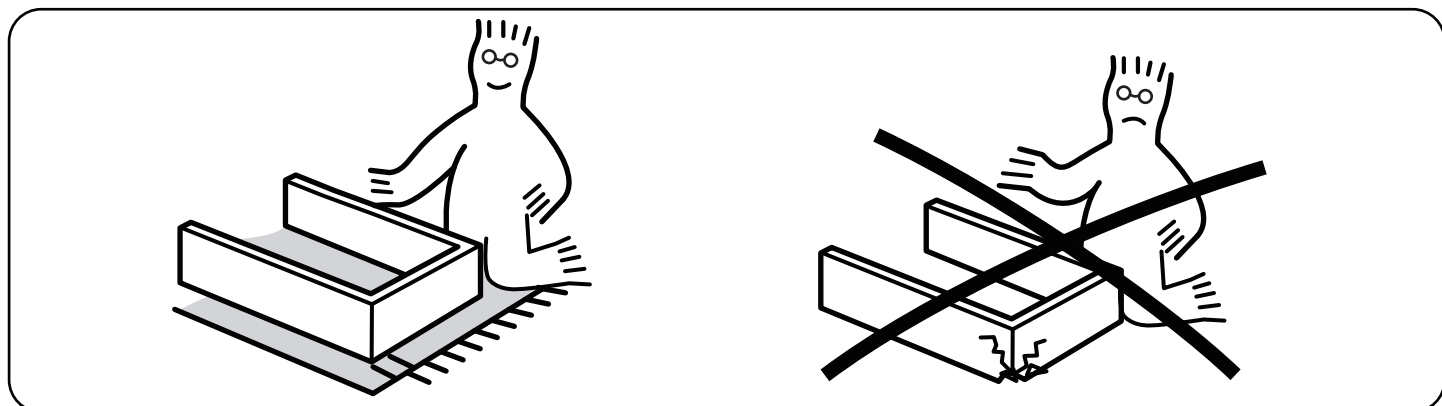

Professional installation is highly recommended.
Eine professionelle Installation wird dringend empfohlen.
Une installation professionnelle est fortement recommandée.
Si raccomanda vivamente l'installazione professionale.
Se recomienda altamente la instalación profesional.



Periodically Check That All Components Are Tightly Secured.
Überprüfen Sie Regelmäßig, Dass Alle Komponenten Fest Gesichert Sind.
Vérifiez Périodiquement Que Tous Les Composants Sont Bien Fixés.
Controllare Periodicamente Che Tutti I Componenti Siano Ben Fissati.
Verifique Periódicamente Que Todos Los Componentes Estén Bien Asegurados.

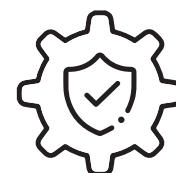

It is recommended that multiple people assemble this product.
Es wird empfohlen, dass mehrere Personen dieses Produkt zusammenbauen.
Il est recommandé que plusieurs personnes assemblent ce produit.
Si raccomanda che più persone assemblino questo prodotto.
Se recomienda que varias personas ensamblen este producto.

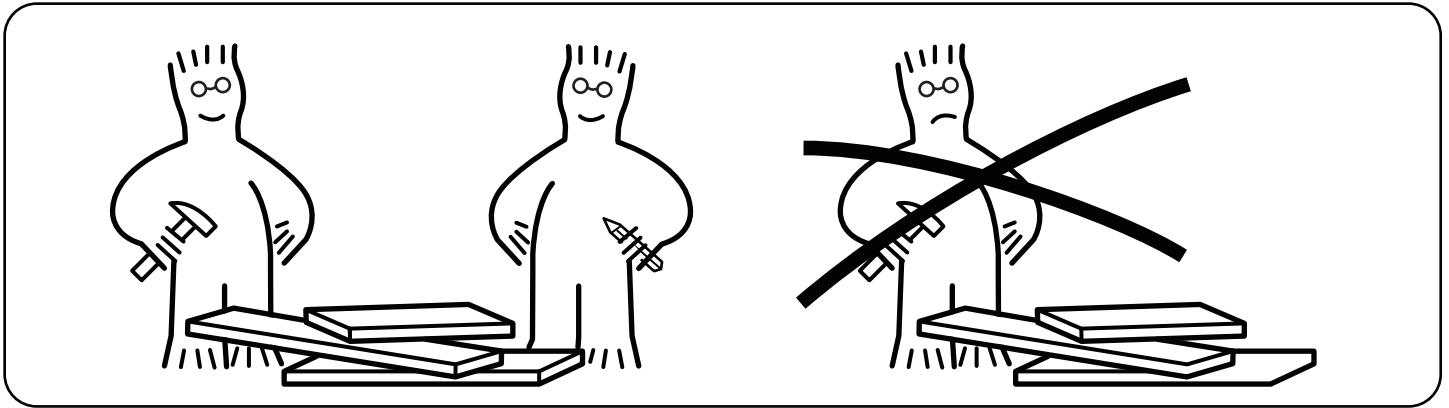

Please have the following auxiliary tools ready:

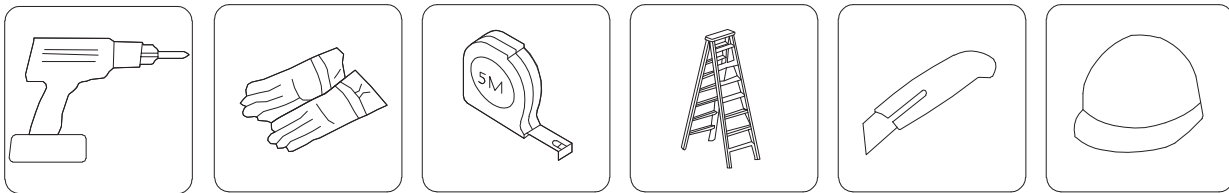

SAFETY GUIDELINES

1. To avoid possible electric shock, turn off the electricity in the main fuse box or on the circuit panel before you begin the fan installation, maintain the fan or install any accessories.
 2. Read all instructions and safety guidelines carefully before installing your fan and follow all the instructions.
 3. Make sure all electrical connections comply with the local codes or ordinances and the national electrical code. If you are unfamiliar with electric wiring, please consult a qualified licensed electrician.
 4. Make sure you have a location that has clear space for the fans' blades to rotate. There is at least seven (7) feet of clearance between the floor and the fan blades' tips. The fan should be mounted at least thirty (30) inches from walls or other upright structures.
 5. **▲ WARNING:** The outlet box and ceiling support joist must be securely mounted, and capable of supporting at least 100 pounds. To reduce the risk of fire, electric shock or personal injury, mount to the outlet box marked "acceptable for fan support" and use mounting screws matching the outlet box. The box must be supported directly by the building structure.
 6. **▲ WARNING:** To reduce the risk of fire, electric shock or personal injury, mount to the outlet box marked "acceptable for fan support" and use mounting screws matching the outlet box. Most outlet boxes are only used for supporting lighting fixtures and not acceptable for fan support. Consult a qualified electrician if in doubt.
 7. Electrical diagrams are for reference only. Light kits don't come with the fan. It must be UL listed and marked "suitable for use with the fan model you are installing". Switches must be UL general switches. Refer to the instructions to properly assemble the fan.
 8. After installing, check that all connections are firmly secured.
 9. After making electrical connections, the spliced conductors should be turned upward and carefully pushed up into outlet box. The wires should be placed separate from the grounded conductor as well as the equipment-grounding conductor on opposite side of the outlet box.
 10. **▲ WARNING:** To reduce the risk of electrical shock and fire, do not use this fan with any solid-state fan speed
 11. Do not operate the reverse switch until the fan has come to a complete stop.
 12. Do not insert anything into the fan's blades while they are rotating.
 13. **▲ WARNING:** To reduce the risk of personal injury, do not bend the blade brackets (also referred to as "flanges")
 14. To avoid personal injury or damage to the fan and other items, be cautious when working around or cleaning the fan.
 15. Do not use water or detergent to clean the fan or its blades. A dry or lightly dampened cloth will be more suitable.
- NOTE:** The important safety precautions and instructions on the manual are not meant to cover all possible conditions and situations that may occur. It is understood that common sense and caution are necessary factors during installing and operating the fan.
- NOTE:** This product is not intended for persons who have badly physical sensory or mental capabilities, or lack certain life experience and knowledge, especially children. Unless such persons are supervised or trained to operate the appliance under the guidance of a person who is responsible for their safety.
- NOTE:** Children should be supervised to ensure that they do not use appliances as toys.
- NOTE:** You must install a switch or circuit breaker that disconnects all power poles, at least 3 mm between each pole.

BEFORE YOU START

Contact a licensed electrician if you are not good at performing electrical work. It's the licensed electrician who installs the fan, if required by the local code. Do not use the fan with a dimmer switch. Turn off power at breaker.

SCREWS BAG

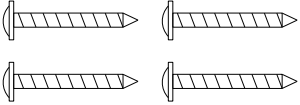
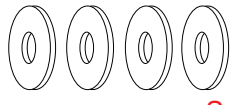
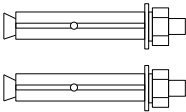
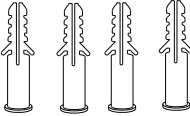
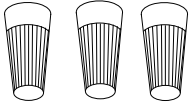
Item no. Nr. N° d'article Articolo No. Artículo No.	Reference Image Referenzbild Image de référence Immagine di riferimento Imagen de referencia	Qty. Menge Qté. Qtà Cant.	Item no. Nr. N° d'article Articolo No. Artículo No.	Reference Image Referenzbild Image de référence Immagine di riferimento Imagen de referencia	Qty. Menge Qté. Qtà Cant.
1	 <p><u>ST5*25</u> <u>Setscrew</u></p>	X4	4	 <p><u>Screw</u> <u>Washer</u></p>	X4
2	 <p><u>Expansion</u> <u>Screw</u></p>	X2	5	 <p><u>Aircraft glue</u></p>	X4
3	 <p><u>Wire Cap</u></p>	X3			

PACKAGE CONTENTS

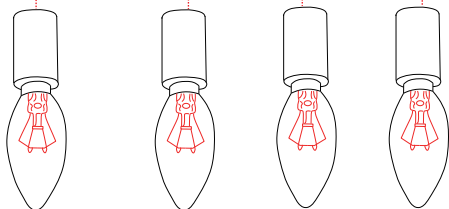
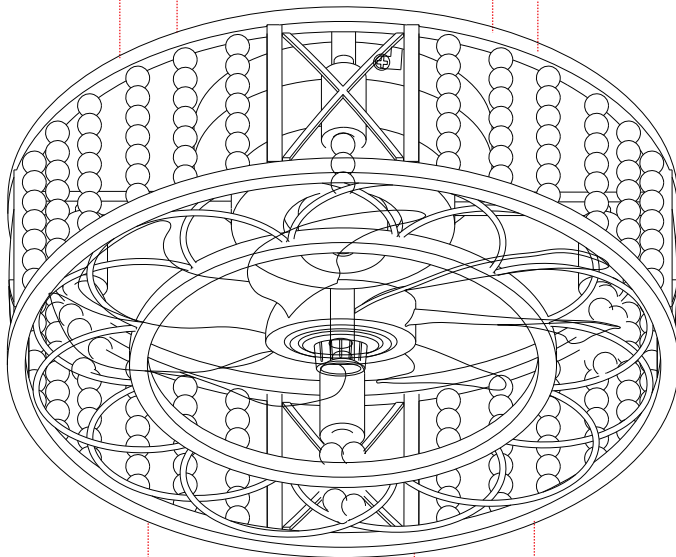
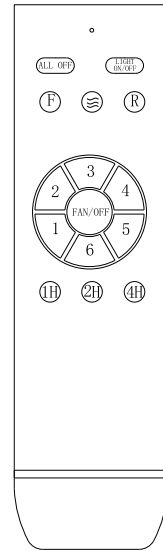
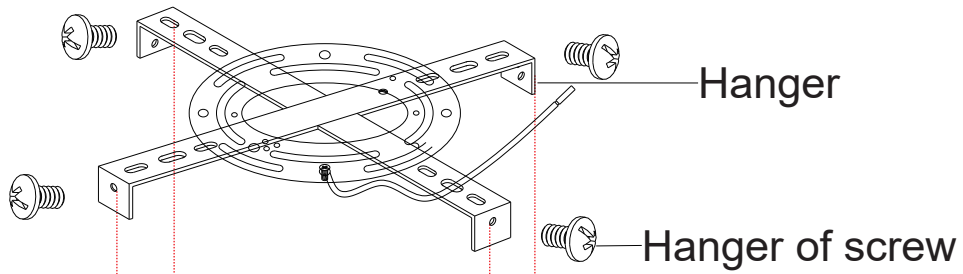

INSTALLING THE MOUNTING BRACKET

1

1. Take the hanger off the top of the fan and remove the four screws as well.

(You only need to remove two screws, and there are two more screws that are already in place, just rotate them in when you install them later)

2. Secure the hanger to the ceiling with aircraft screw and setscrew inside the screw pack.

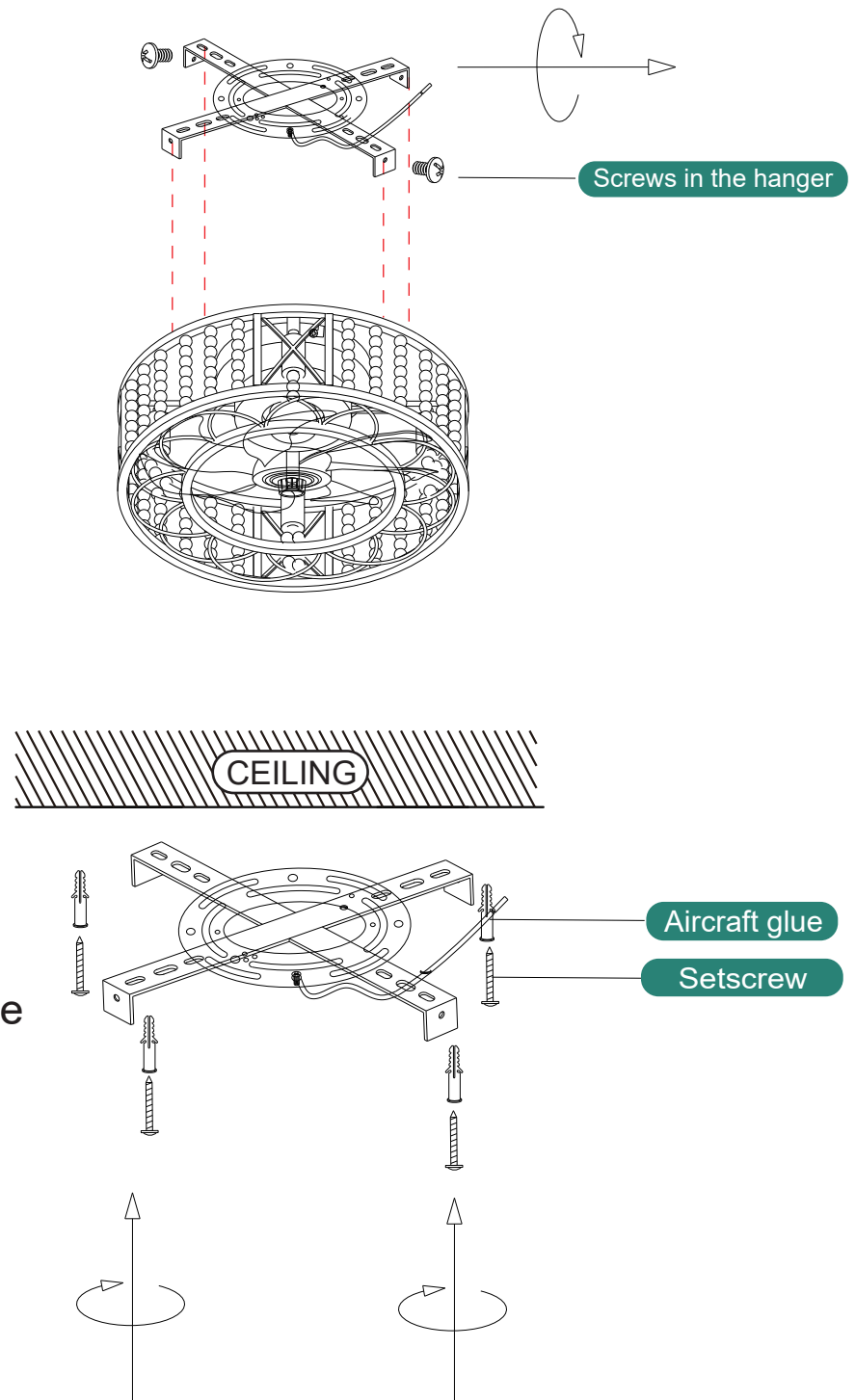

INSTALLING WIRES

2

1. Mount the white and black wires from the fan to the black and white wires on the wall of your home.

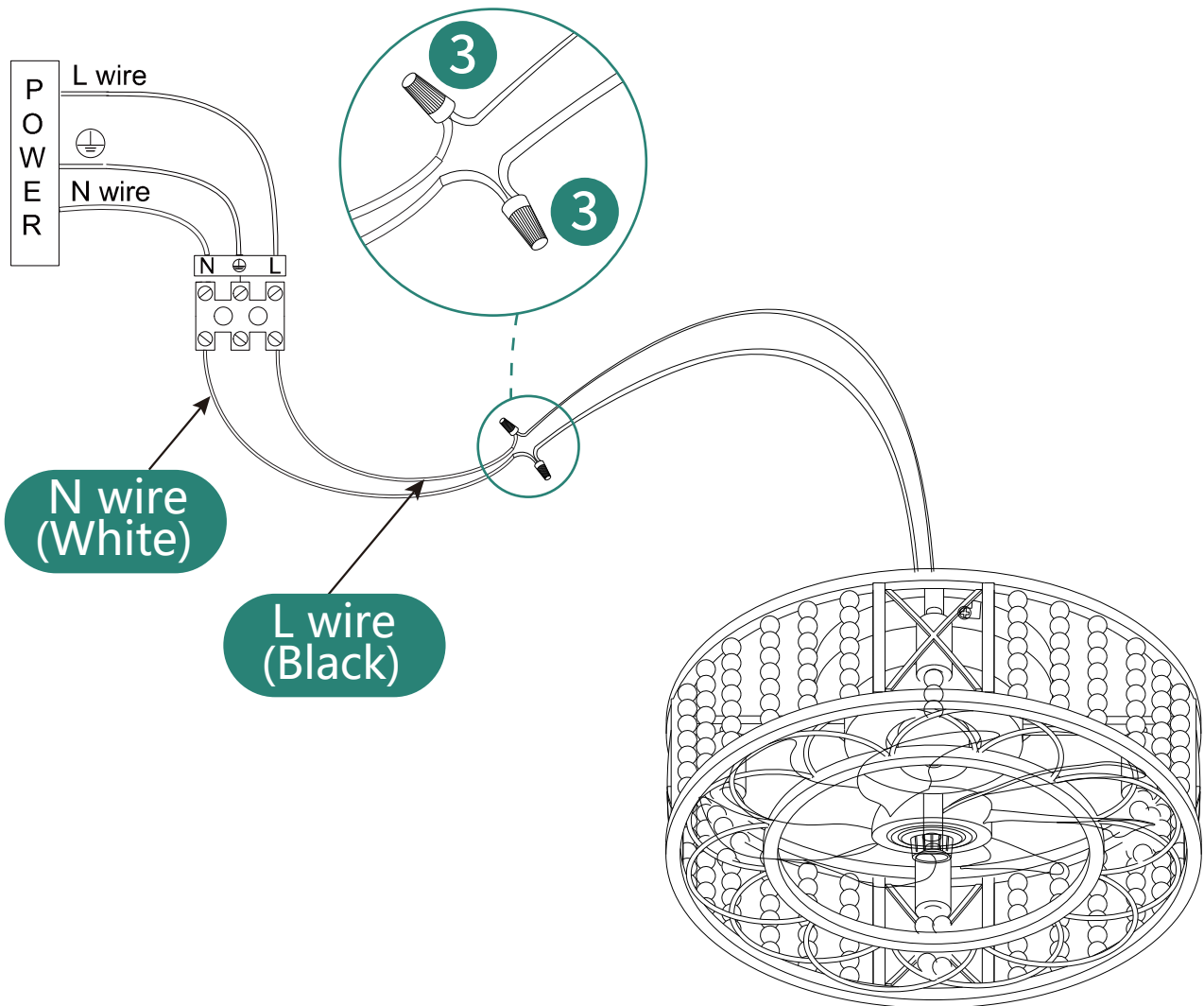

INSTALLING FANS AND LIGHT BULBS

3

1. Reinstall the four screws that were removed to the hangers.

2. Rotate the bulb to install it inside the fan.

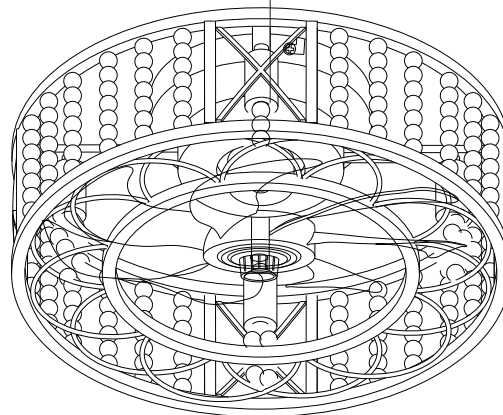
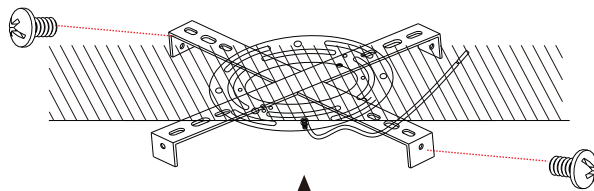

Ceiling Fan Shade

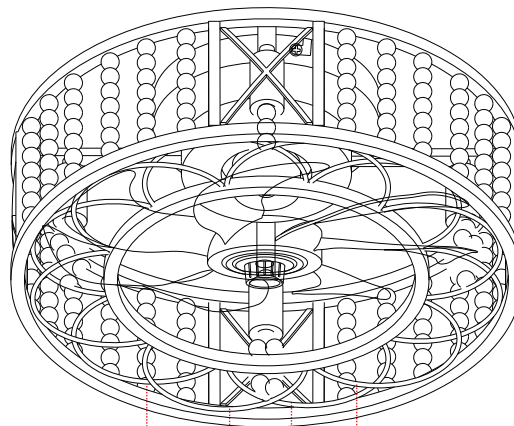

E12 Bulbs x 4 (Not Included)
Install the bulb upwards into the four holes in the lampshade

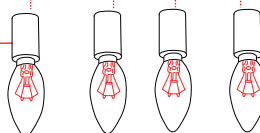

INSTALLATION COMPLETED

4

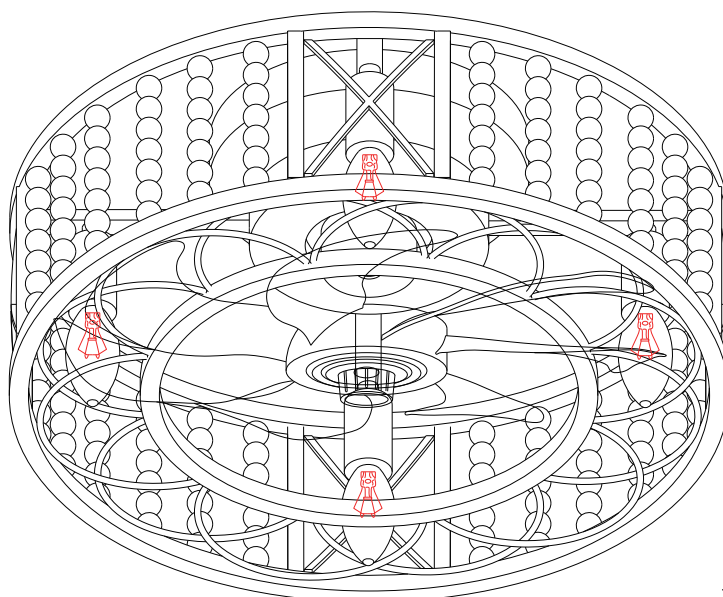

Installation Completed

Installation Abgeschlossen

Installation Complétée

Installazione Completata

Instalación Completada

REMOTE CONTROL SETTING AND OPERATION

1. Restore electricity to the outlet box by turning the electricity on at the main fuse box.
2. Remove the battery cover from the remote control transmitter, install the battery, and replace the cover.

Note: 1). Please use two 1.5v AAA sections to power the remote transmitter



- 2). If not used for a long period of time, remove the battery to prevent damage to the remote transmitter, and store the remote transmitter away from excess heat or humidity.
- 3). Batteries are **not** included in the package, please purchase separately

3. The buttons on the remote control transmitter control the fan speed and light as follows.

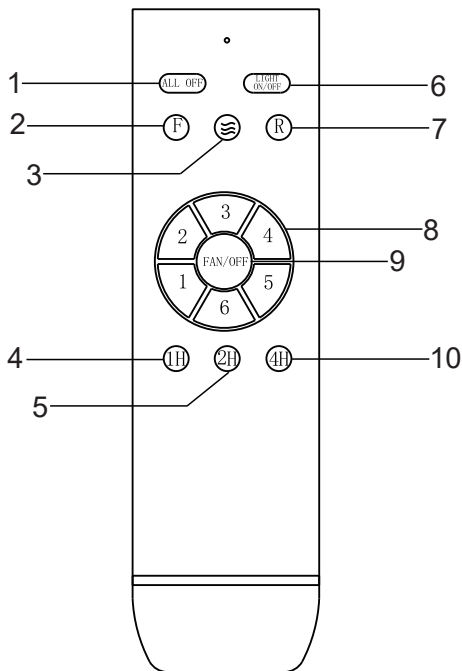

1. ALL OFF
2. FORWARD WIND
3. NATURAL WIND
4. 1 HOUR TIMING
5. 2 HOUR TIMING
6. LIGHT ON/OFF
7. REVERSE WIND
8. 6 SPEEDS
9. FAN/OFF
10. 4 HOUR TIMING

Press the F/R key when the fan is running, and the fan will automatically stop and rotate in the opposite direction.

If needed, install the remote control holder onto a wall or any other suitable flat surface using appropriate fasteners. For wood or other thinner and weaker surfaces, use the provided steel screws and plastic anchors. For reinforced concrete or similar surfaces, use anchor bolts for best results.

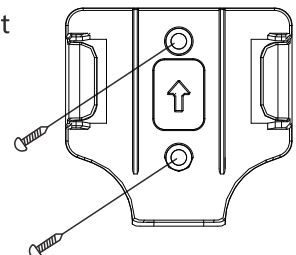

TROUBLESHOOTING

Your fan may occasionally jerk forward or backward upon starting up.

This is normal and does not affect the fan operation.

Try these troubleshooting steps before contacting customer service.

SYMPTOM	POSSIBLE SOLUTIONS
The fan doesn't spin	<ol style="list-style-type: none"> 2. Check the functionality of circuit breaker or fuse panel and wall switch. 3. Confirm fan wires are correctly connected to the house wires. 4. Make sure the blocker of the fan motor is removed. 5. Use your remote to check the power to the breaker and try to work your ceiling fan manually from afar (Normal switch only for the fan power on/off)
The fan's light does not work	<p>Make sure the LED light kit and light bulb are connected well.</p>
The fan is noisy and wobbling	<ol style="list-style-type: none"> 1. Confirm the blade screws are NOT rubbing against the the motor's round plastic part. 2. Confirm the pin wire are NOT connected against the moving part. 3. Confirm the coupling cover is NOT hitting the motor 4. Confirm the down rod is NOT slanted 5. Tighten any loose screws on the light kit, fan blades, motor coupling, down rod, brackets and mounting hardware. 6. Confirm the hanger ball is firmly seated in the mounting bracket. 7. The ceiling beam must meet the minimum tensile test strength of 30KG for installation. 8. Make sure the airfoils and brackets are NOT bent or deformed. 9. Confirm the wire connections are not rattling against each other. 10. Confirm the fan blades are not cracked. If the fan blades are cracked, replace the damaged blades with the set of new blades of same brand as your ceiling fan ensures the compatibility. 11. Change fan blades' positions. 12. Confirm the light kit is NOT slanting and hitting the motor. 13. Confirm all the blades are screwed firmly into blade holders.
The fan or light automatically turns on/off	<ol style="list-style-type: none"> 1. Confirm the circuit breaker is not malfunctioning. 2. Confirm the wire connections are not frayed. 3. Confirm the app does not set the timer or schedule 4. Power off the fan for 10 minutes, then power on again.

HELP CENTER



Inquiry



Assembly issue



Missing parts

If you encounter any difficulties during assembly, please contact us.

Wenn Sie während der Montage auf Schwierigkeiten stoßen, kontaktieren Sie uns bitte.

Si vous rencontrez des difficultés lors du montage, veuillez nous contacter.

Se incontri difficoltà durante il montaggio, ti preghiamo di contattarci.

Si encuentras alguna dificultad durante el ensamblaje, por favor contáctanos.

DISCLAIMER

Manufacturer and seller expressly disclaim any and all liability for personal injury, property damage or loss, whether direct, indirect, or incidental, resulting from the incorrect attachment, improper use, inadequate maintenance, unapproved modification, or neglect of this product.

Der Hersteller und Verkäufer lehnen ausdrücklich jegliche Haftung für Personenschäden, Sachschäden oder Verluste ab, egal ob direkt, indirekt oder zufällig, die durch falsche Anbringung, unsachgemäßen Gebrauch, unzureichende Wartung, nicht genehmigte Änderungen oder Vernachlässigung dieses Produkts entstehen.

El fabricante y vendedor renuncian expresamente a toda responsabilidad por lesiones personales, daños materiales o pérdidas, ya sean directos, indirectos o incidentales, derivados de la incorrecta colocación, uso inadecuado, mantenimiento insuficiente, modificación no aprobada o negligencia de este producto.

Il produttore e il venditore declinano espressamente ogni responsabilità per lesioni personali, danni materiali o perdite, dirette, indirette o incidentali, derivanti dall'errato fissaggio, uso improprio, manutenzione inadeguata, modifica non autorizzata o negligenza di questo prodotto.

Le fabricant et le vendeur déclinent expressément toute responsabilité en cas de blessures corporelles, de dommages matériels ou de pertes, qu'ils soient directs, indirects ou accessoires, résultant de la fixation incorrecte, de l'utilisation inappropriée, de l'entretien insuffisant, de la modification non approuvée ou de la négligence de ce produit.