

CARE AND MAINTENANCE

Spot clean using a mild water-free solvent. Only a professional cleaner should undertake a complete overall cleaning.

The use of steam or water-based cleaners may cause excessive shrinking or staining.







NOTICE

* Please make sure that you have all parts indicated before you begin assembly of this item

* This item should be assembled on a soft surface to prevent scratching the finish during assembly

* This item may require periodic tightening

Part List and Hardware List

PIECE	DESCRIPTION	PICTURE	QUANTITY
A	SEAT		1X
B	Front leg		2X
C	Rear leg		2X
H1	Allen bolt L		8X
H2	Spring washer		8X
H3	Flat washer		8X
H4	Allen key		1X

Product Dimensions: 22.4" W x 27.9" D x 31.8" H

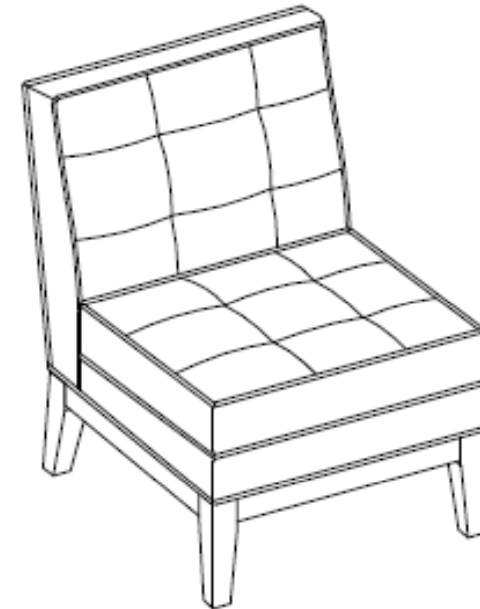

PREPARATION

Before beginning assembly of product, make sure all parts are present. Compare parts with package contents list and hardware contents list.

If any part is missing or damaged, do not attempt to assemble the product.

Estimated Assembly Time: 10 minutes.

Tools Required for Assembly (included): Allen Key

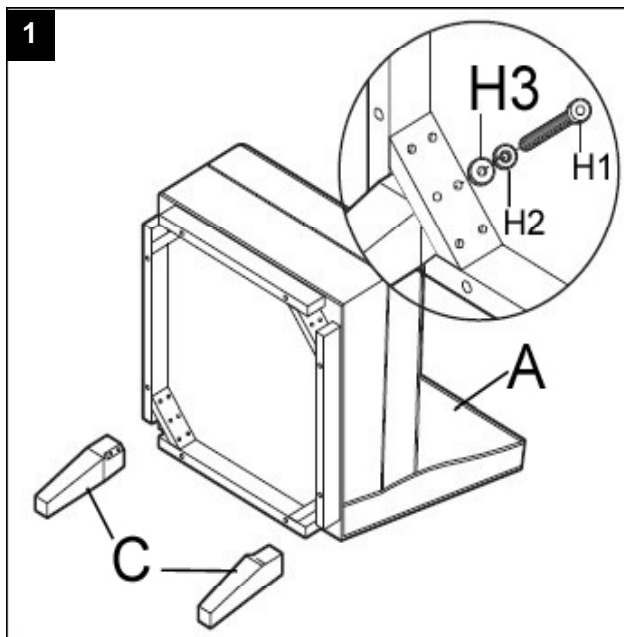

Step 1
Attach rear leg(C) to seat (A),
using Allen bolt L(H1), flat washer (H3),
and Spring washer (H2), Tighten with allen key (H4)

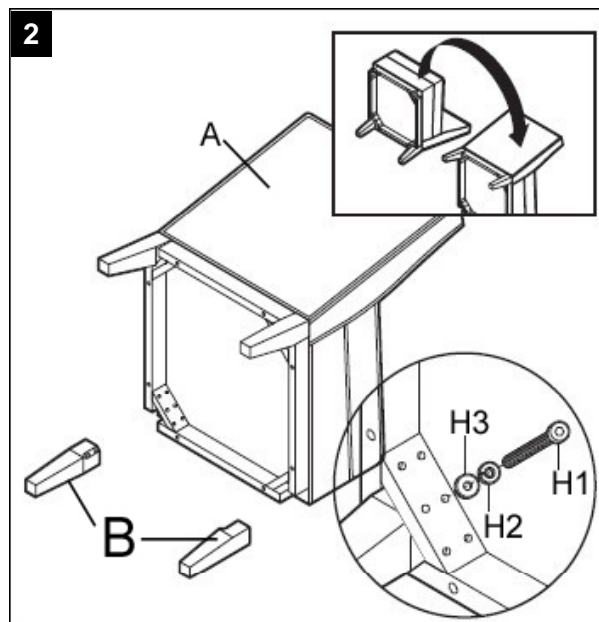

Step 2
Attach front leg(B) to seat (A),
using Allen bolt L(H1), flat washer (H3),
and Spring washer (H2), Tighten with allen key (H4)