

PLEASE INSPECT ALL PARTS PRIOR TO ASSEMBLY AND CONTACT US IF ANY OF THE PARTS ARE DAMAGED OR MISSING. THIS MUST BE DONE BEFORE ATTEMPTING ASSEMBLY.

Thank you for purchasing this Pioneer Desk. Please read the instructions carefully before assembly and use to ensure safe and satisfactory operation of this product.

Tools:

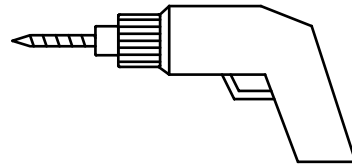
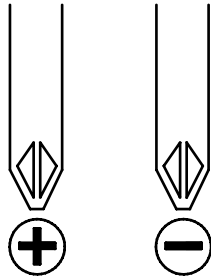
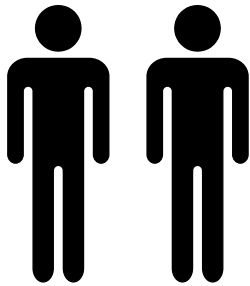

**Notes: Some of the tools shown here are optional and are required only for quick assembly of this product**

Please check the pack contents before attempting to assemble this product. A full checklist of components is given in this leaflet. If any components are missing, please contact the retailer from whom you bought this product.

This product is **HEAVY**, it should be assembled as near as possible to the point of use. **TAKE CARE WHEN LIFTING** to avoid personal injury and(or) damage to the product.

This product takes approximately **60MINUTES** to assemble with **2 PEOPLE**.

The fittings pack contains **SMALL ITEMS** which should be **KEPT AWAY FROM YOUNG CHILDREN**.

Read this leaflet in full before commencing assembly.

**Max printer weight: 10kg**



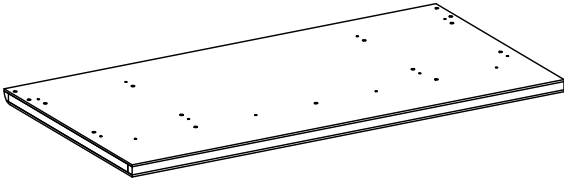

**A** x1

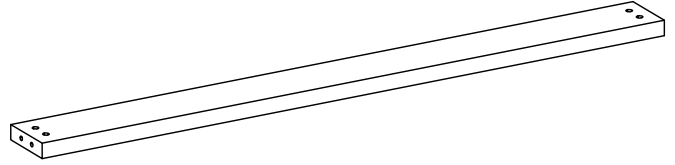

**B** x1

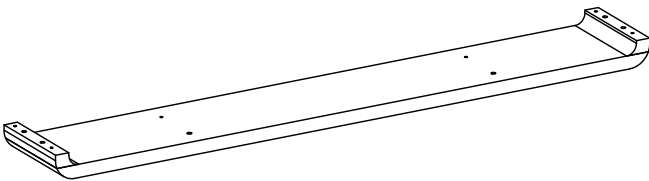

**C** x1

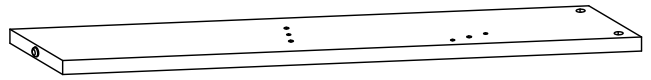

**D** x1



**E** x1

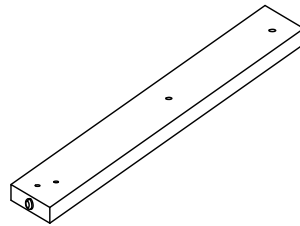

**F** x1

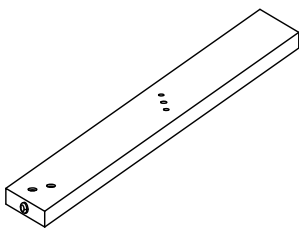

**G** x1

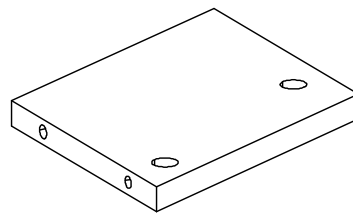

**H** x2

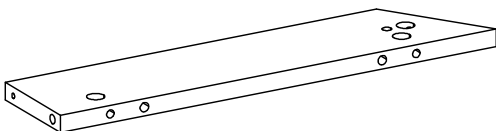

**I** x1

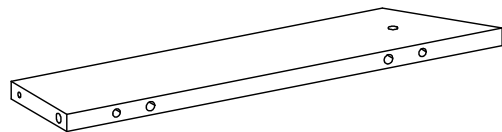

**J** x1

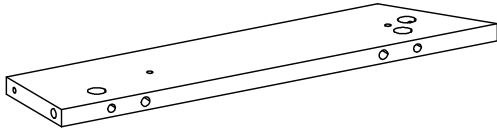

**K** x1

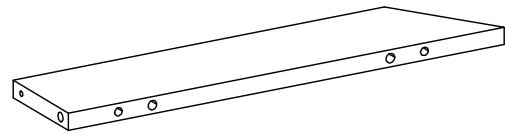

**L** x1

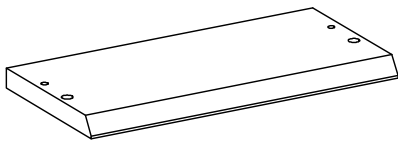

**M** x1

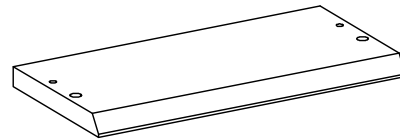

**N** x1

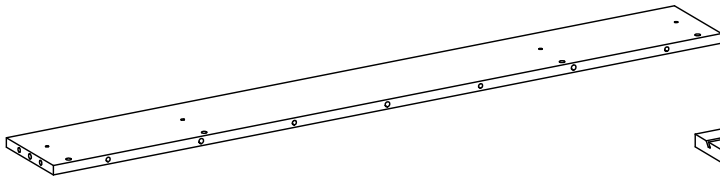

**O** x1

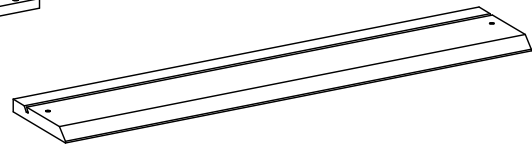

**P** x1

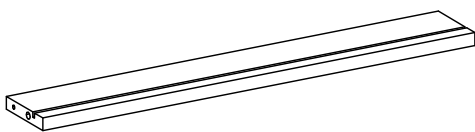

**Q** x1



**R** x1

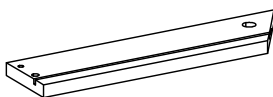

**S** x1

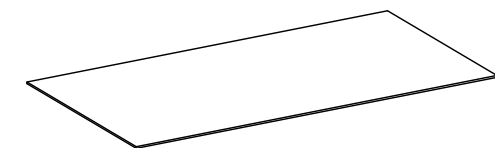

**T** x1



**U** x26

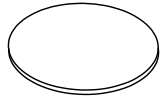

SONOMA OAK LIGHT

**W** x20

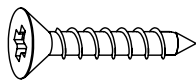

**Y** x8

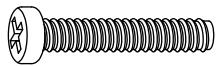

**A1** x2

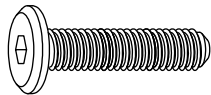

**C1** x2

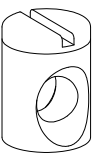

**E1** x8

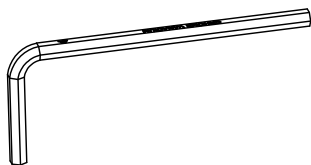

**G1** x1

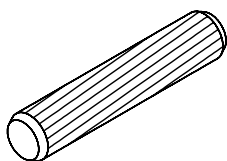

**I1** x6

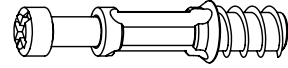

**V** x26

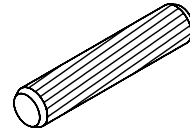

**X** x33

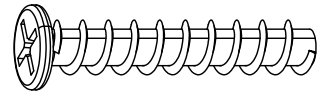

**Z** x6

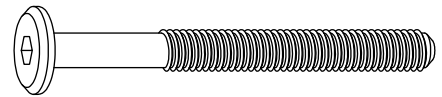

**B1** x8

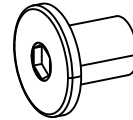

**D1** x2

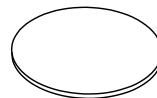

WHITE

**F1** x6

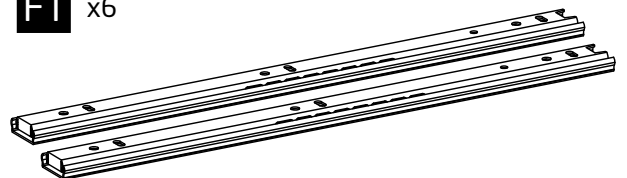

**H1** x1

1

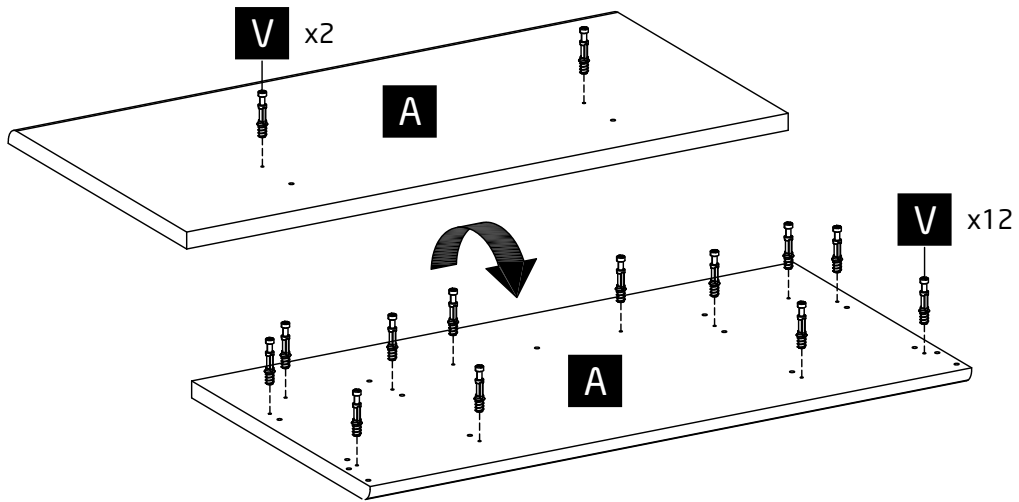

2

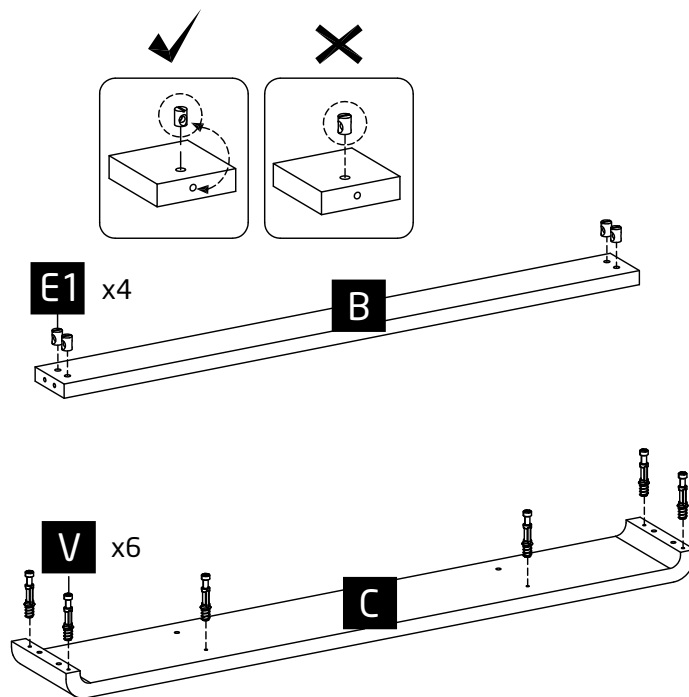

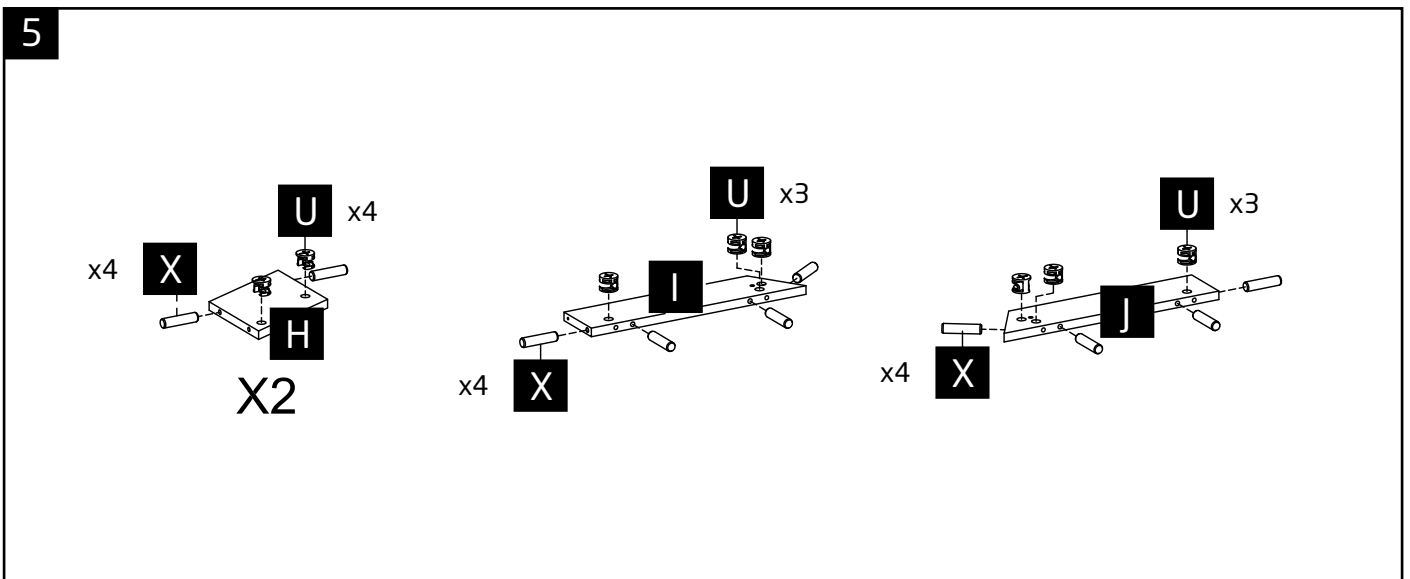
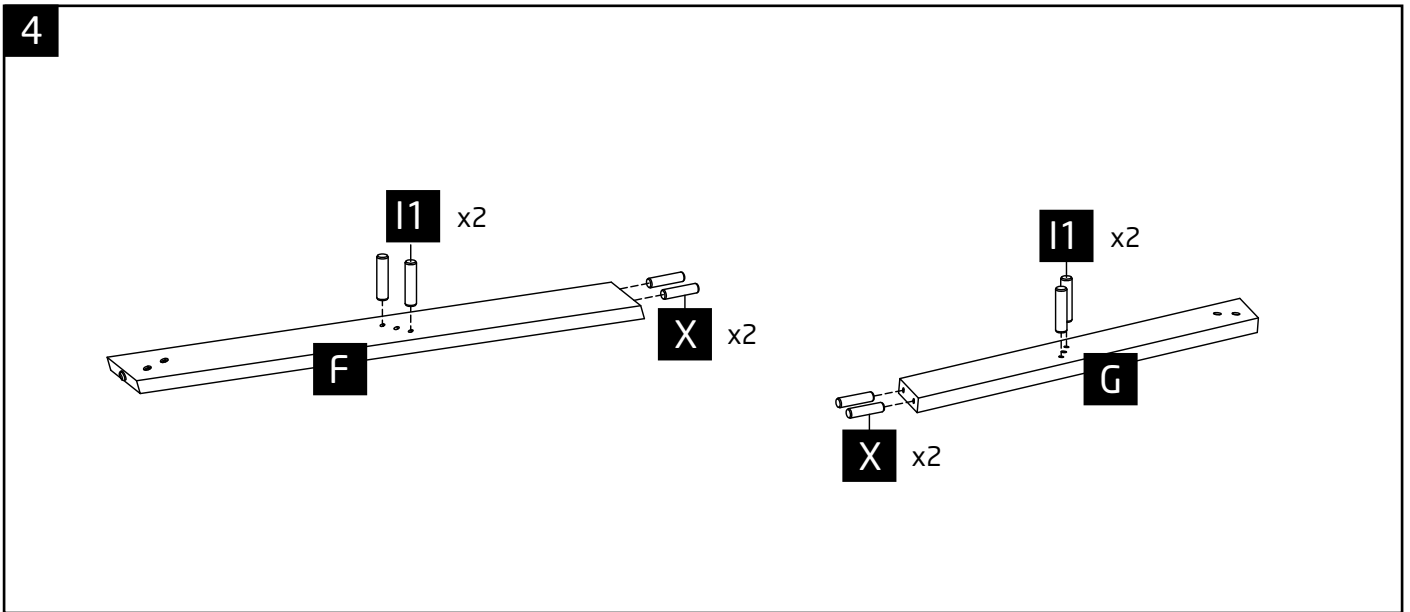
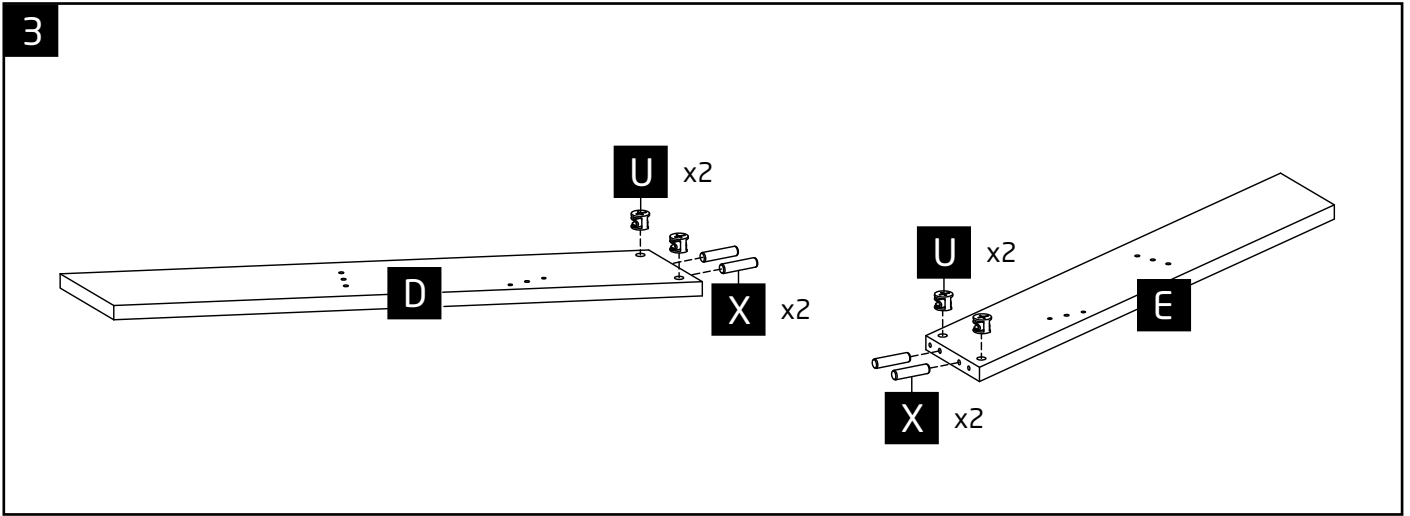

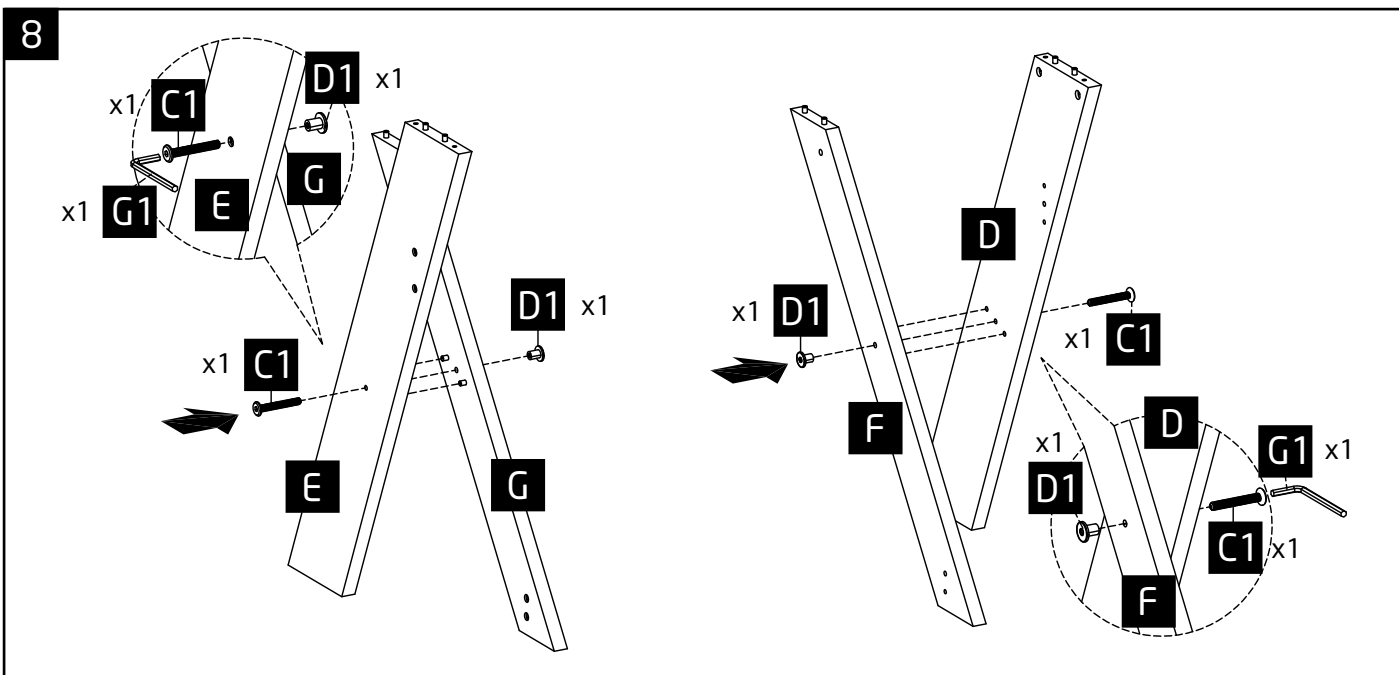
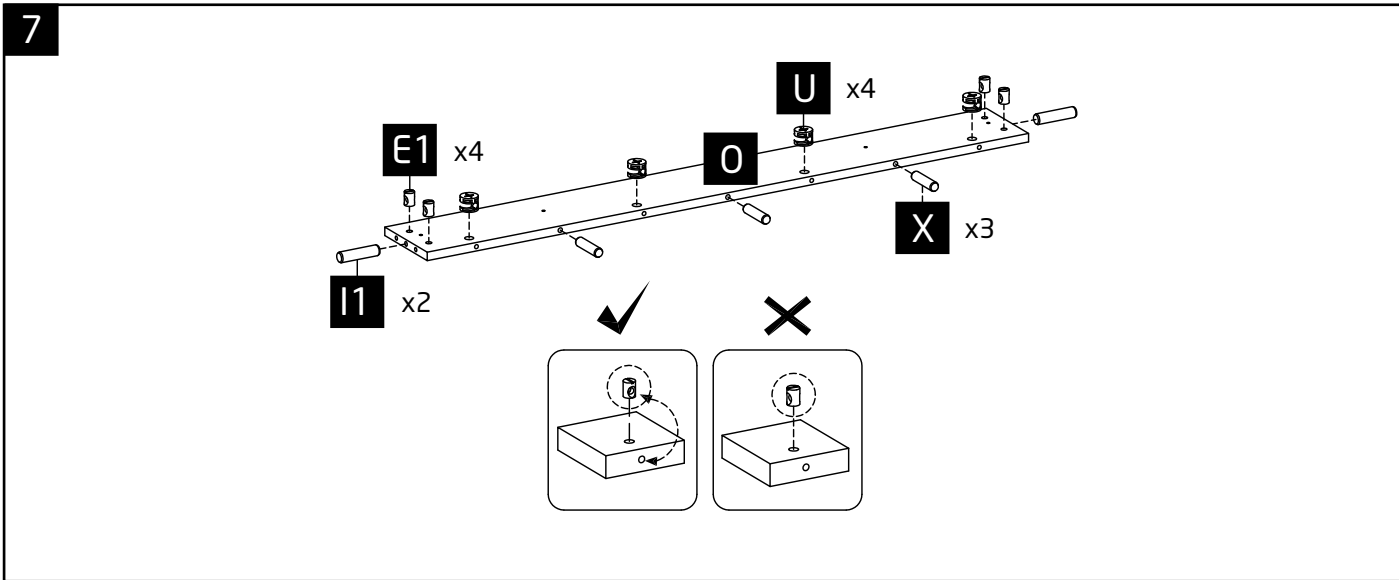
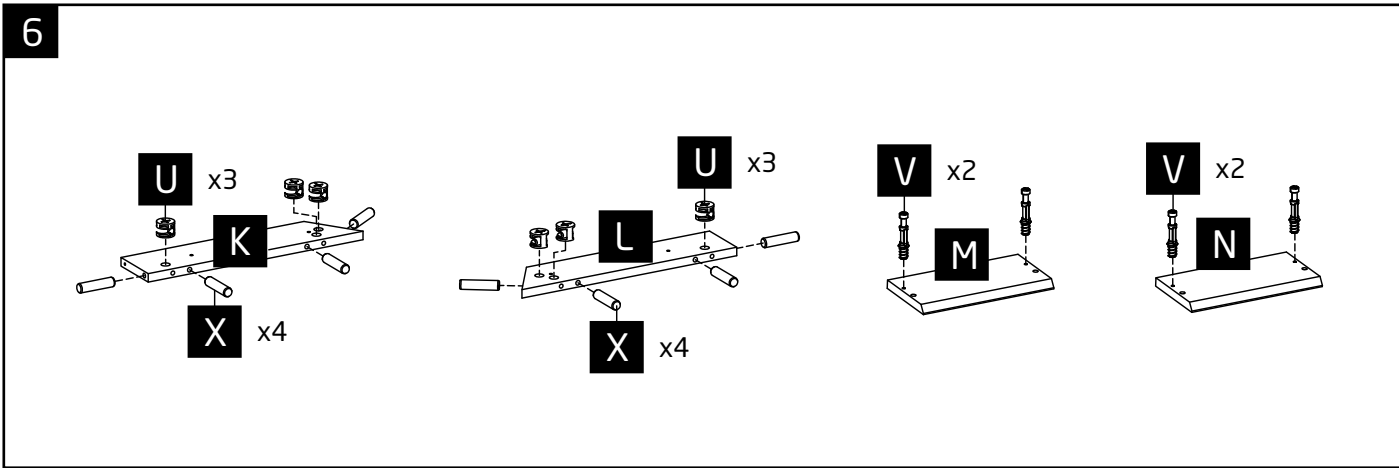

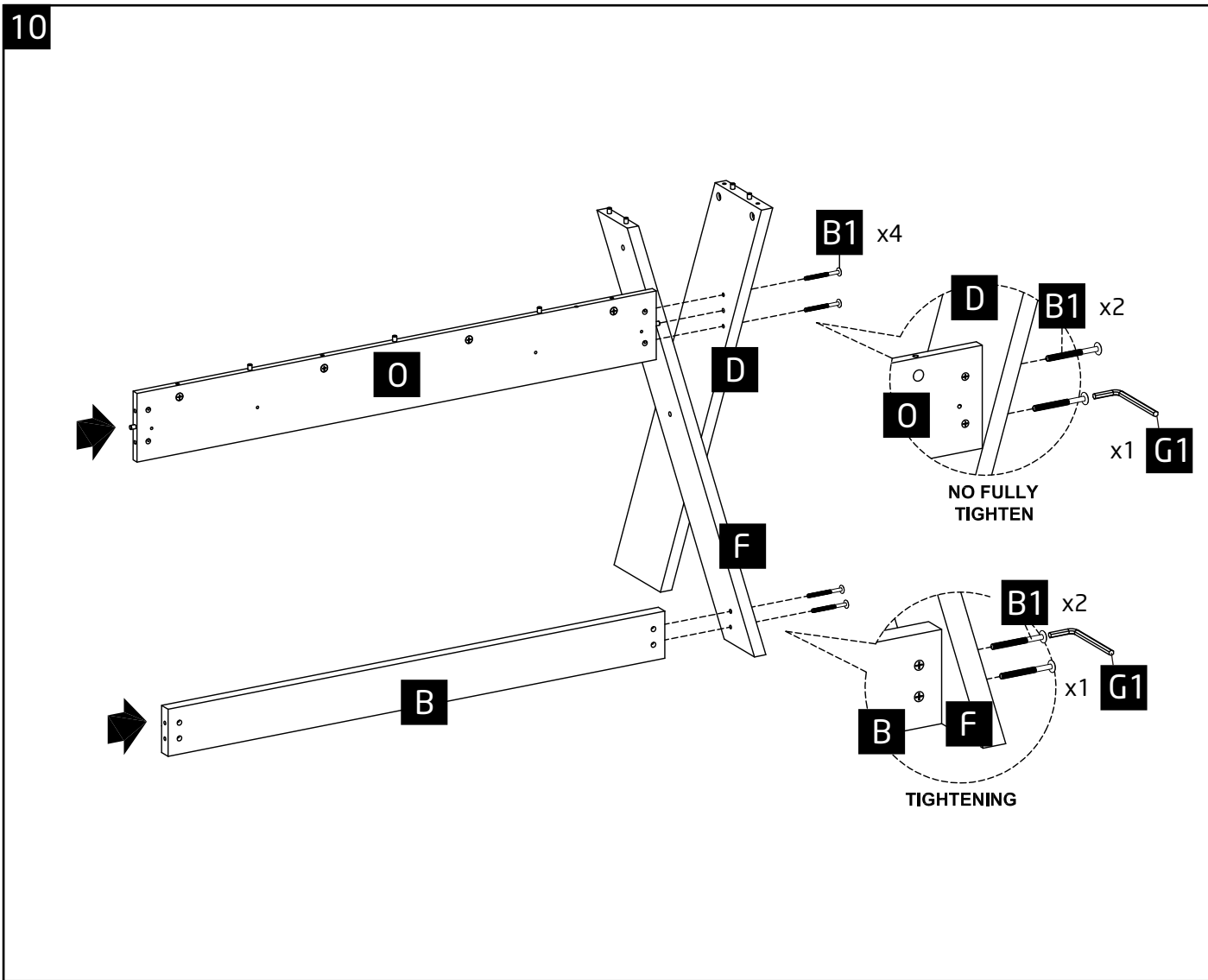
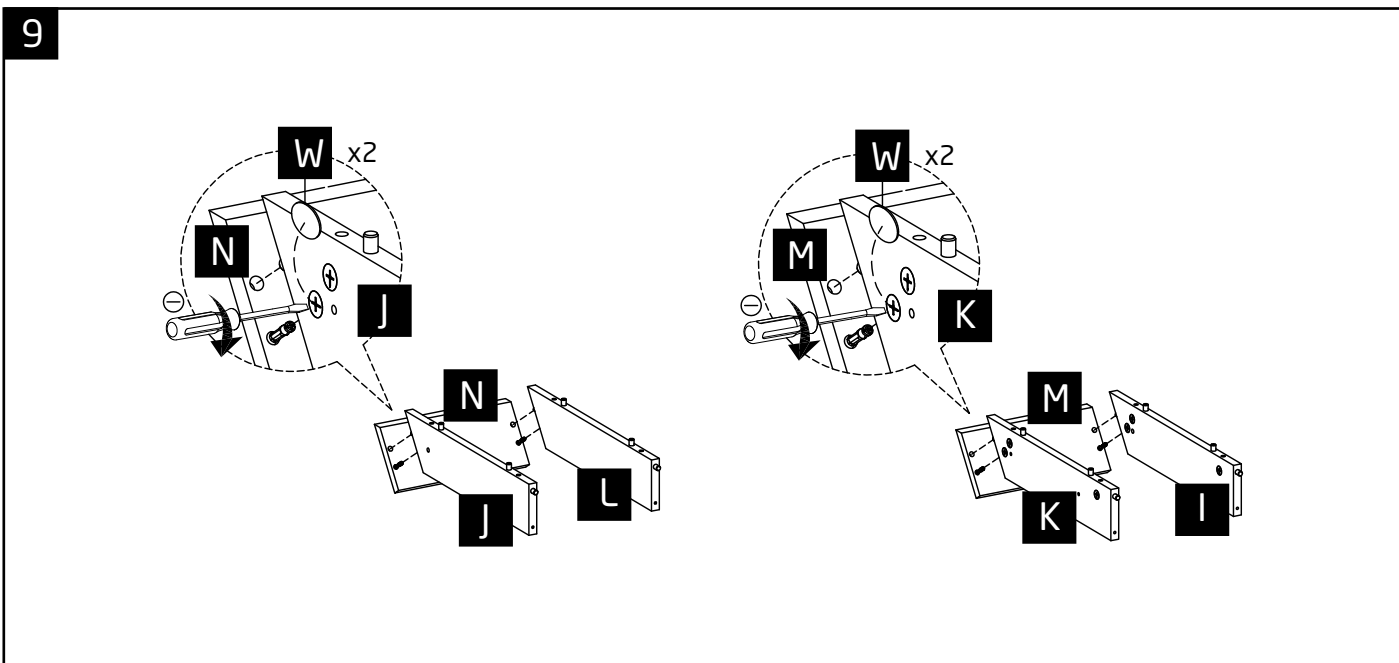

11

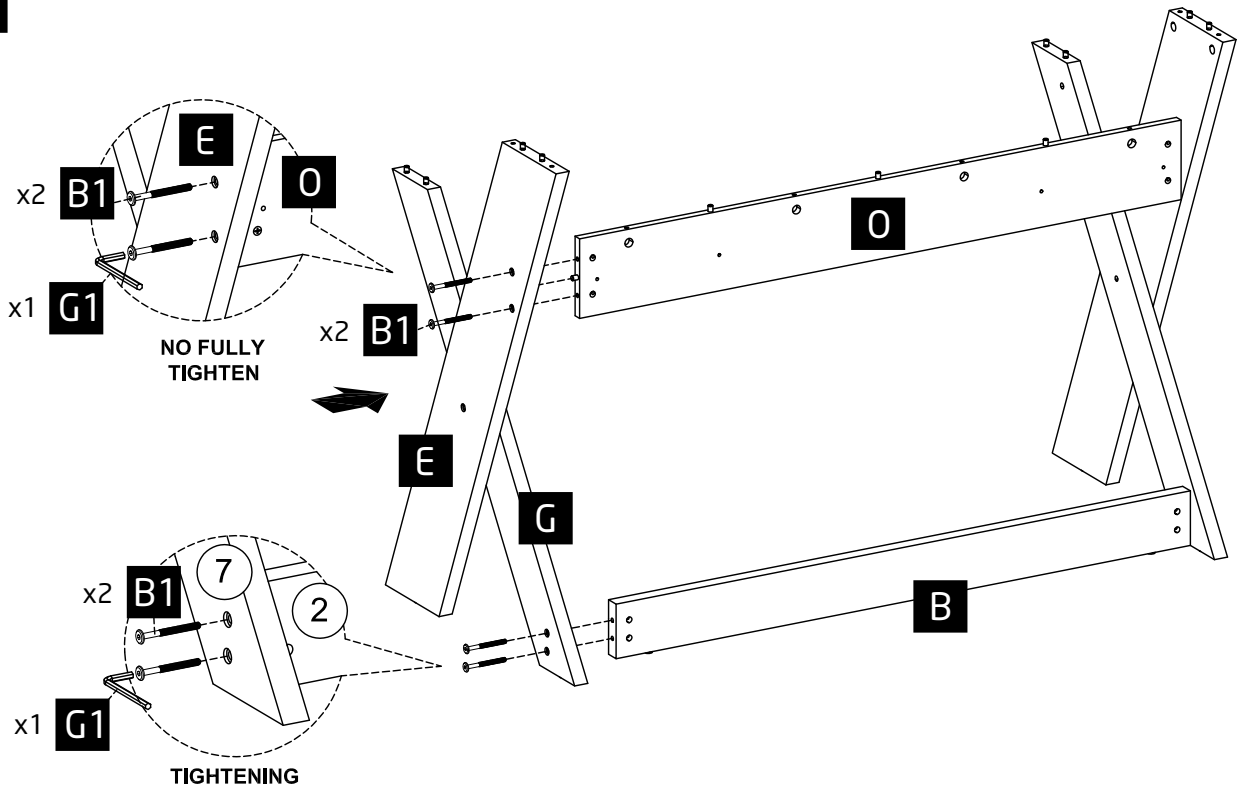

12

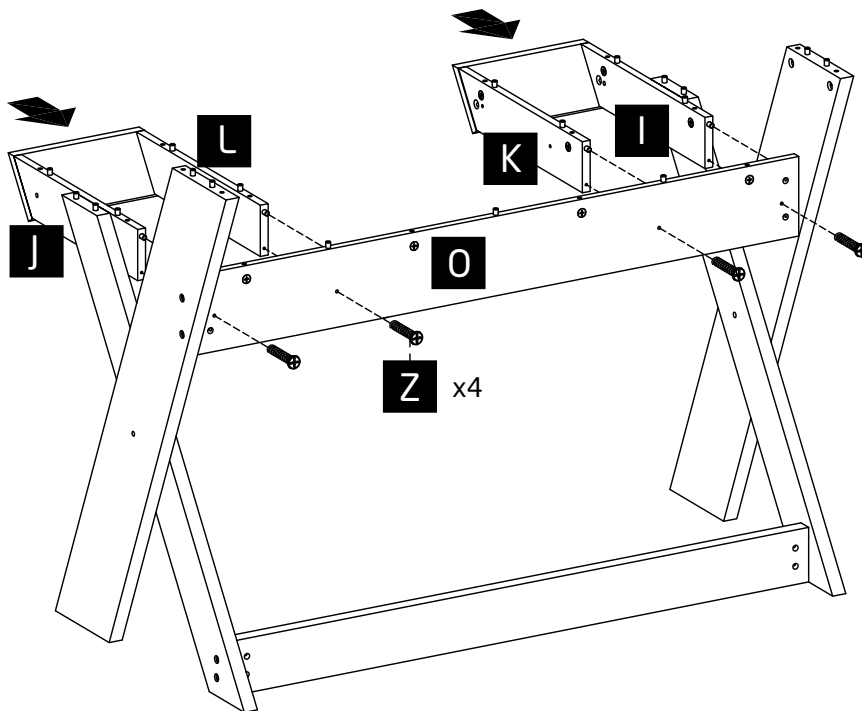

13

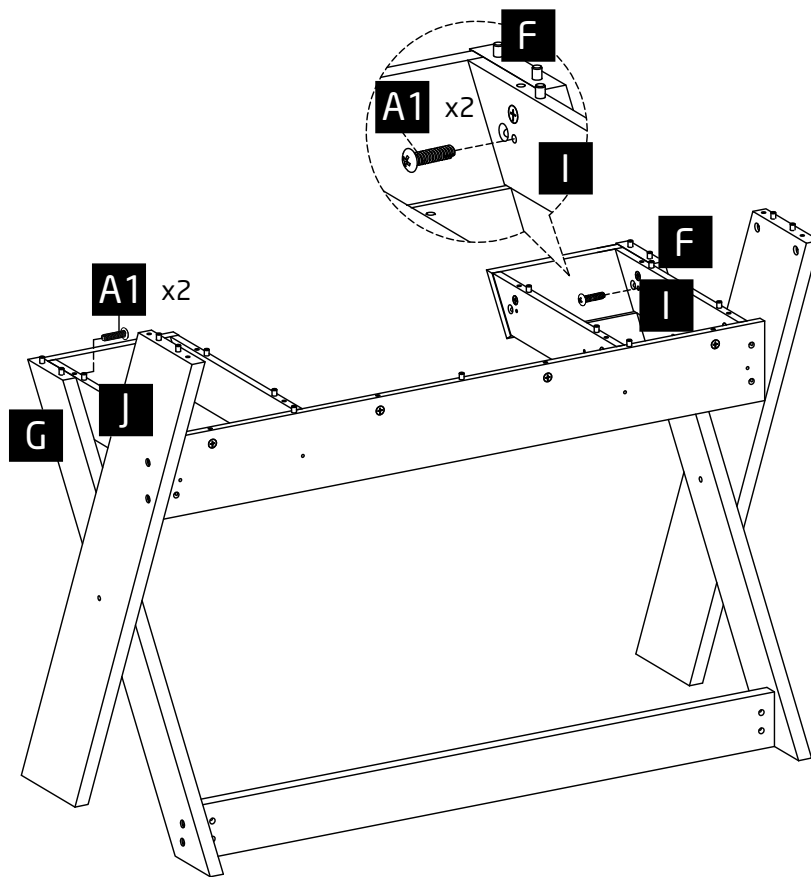

14

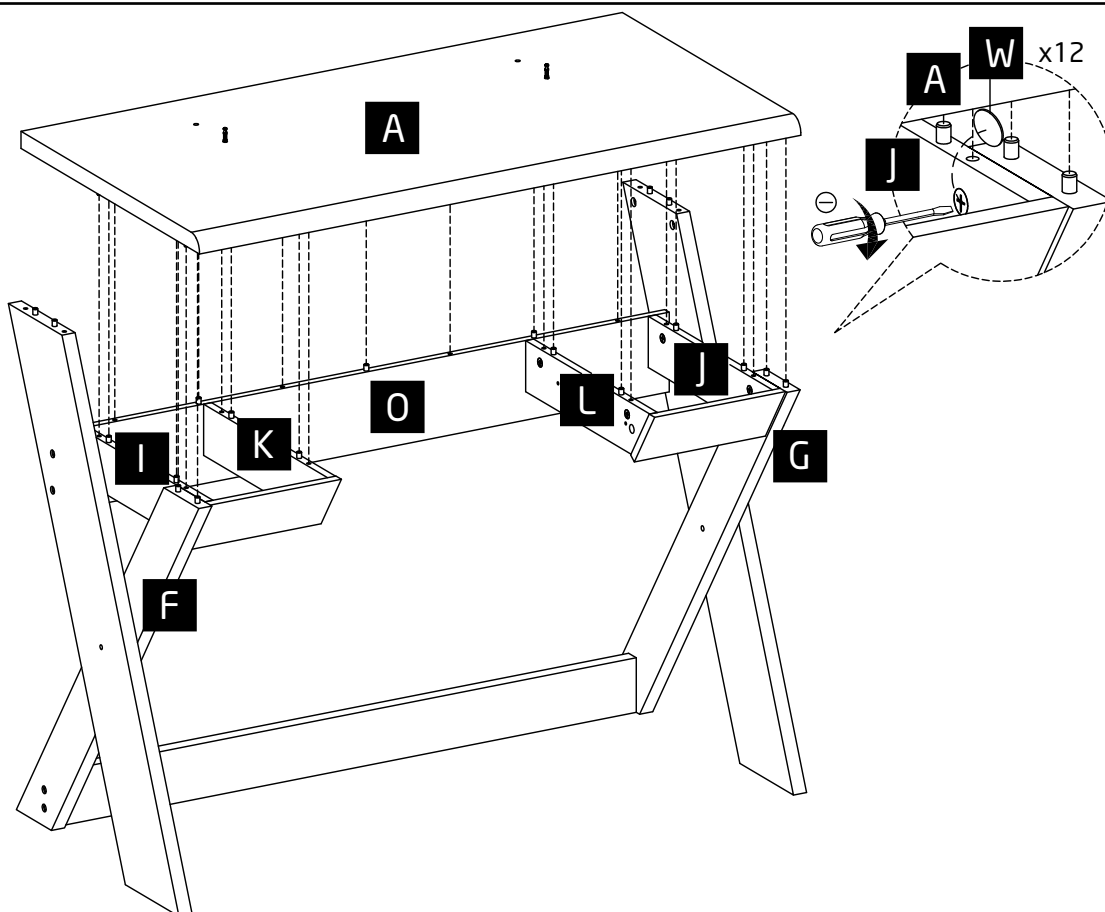

15

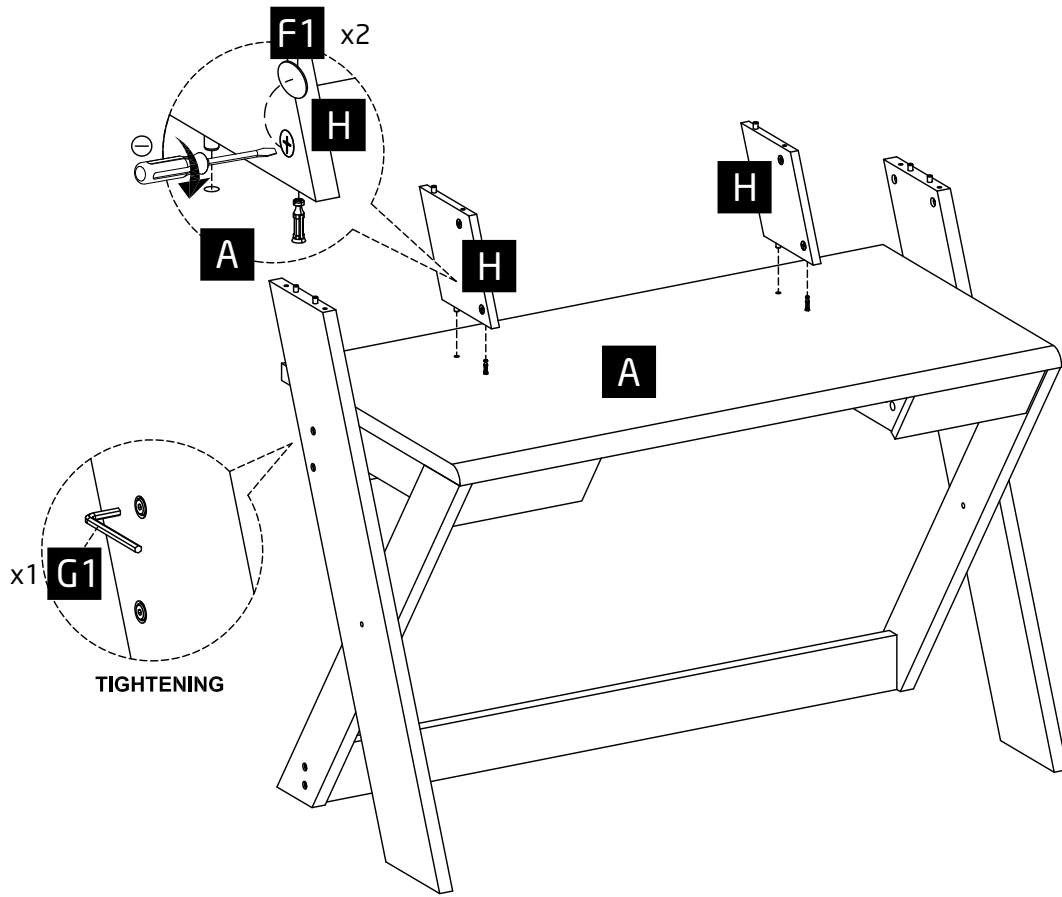

16

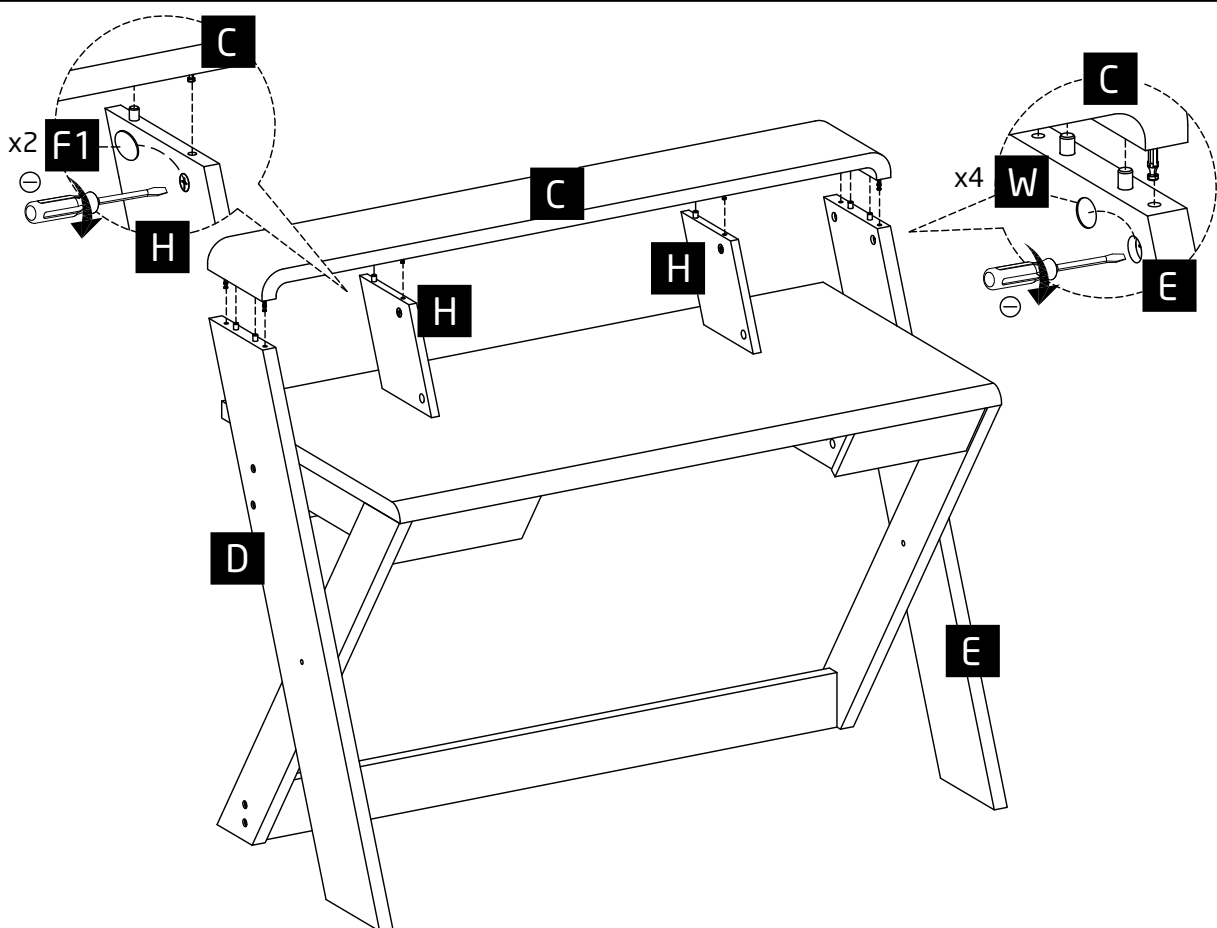

17

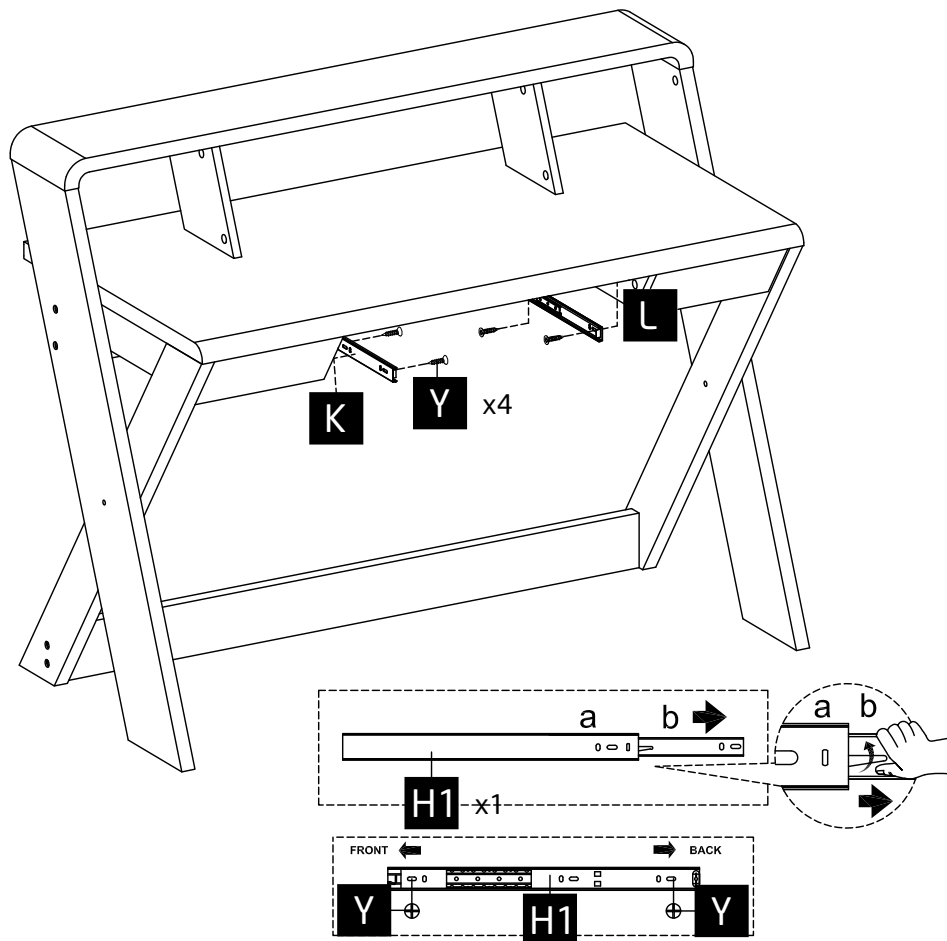

18

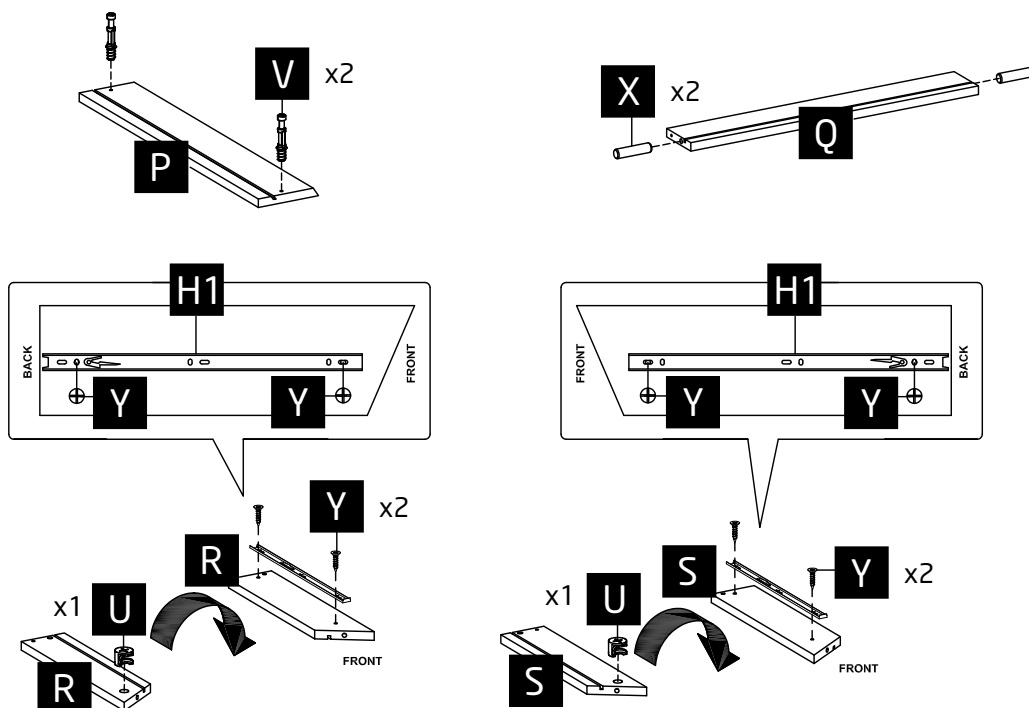

19

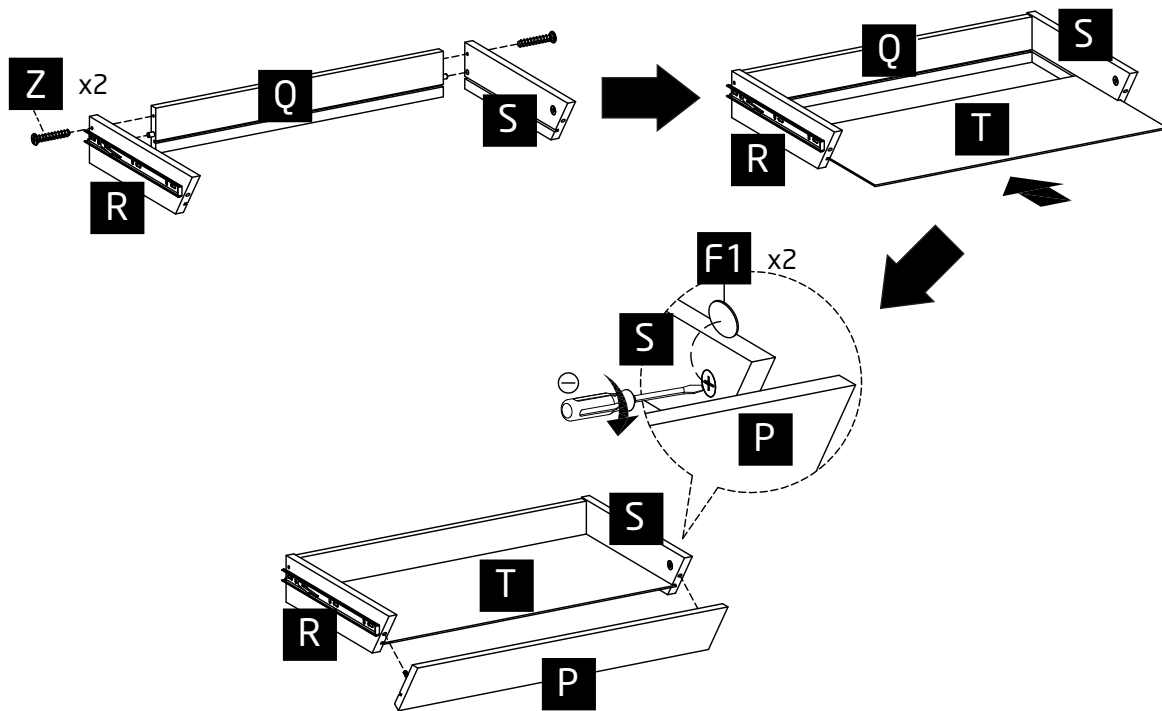

20

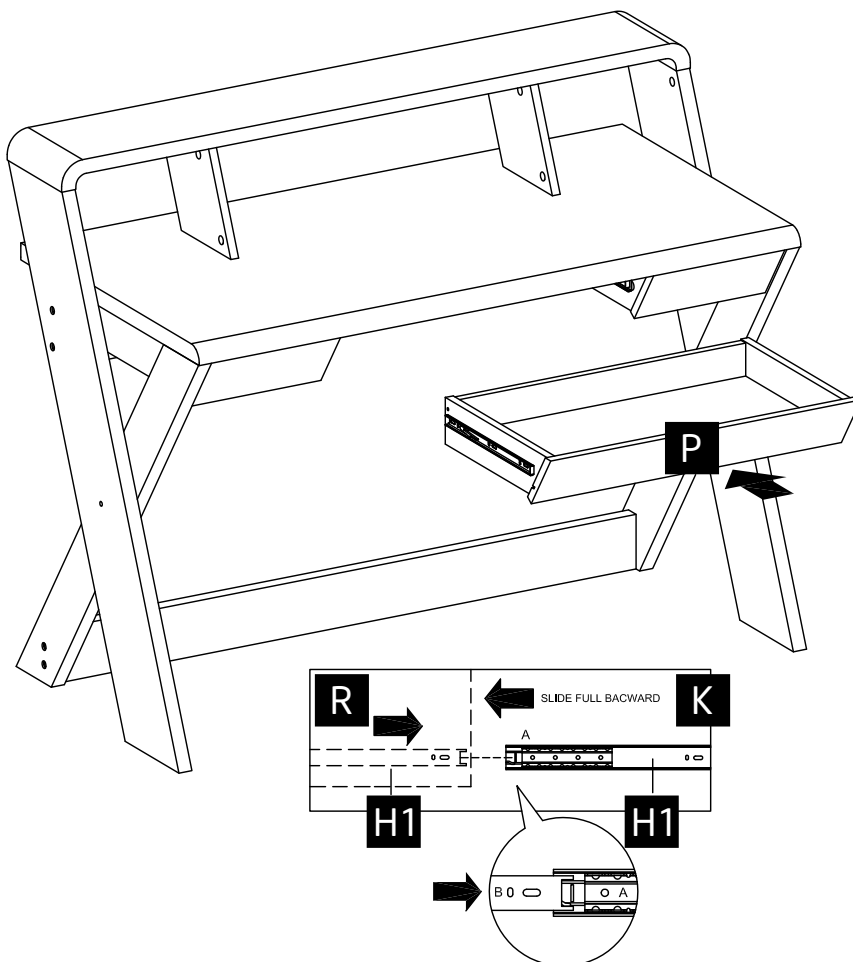

### **How to care for your wood furniture**

Furniture with a hard lacquer, wax polish or painted surface should be dusted with a dry cloth.

Waxed furniture will need to be given a coat of beeswax a couple of times a year to help maintain its luster.

Spray polishers are best avoided as they contain silicones which may spoil the furniture's surface by building up over time.

Make sure all surfaces are protected from heat and liquids by mats and coasters. Wipe up spills immediately and ensure that a mat or a pad is placed under paper if you are writing.

Extendable dining tables should be left extended for the first few months to avoid an uneven appearance. Likewise, lamps and ornaments should also be moved regularly.

Our furniture will endure most temperatures in the home but it is best to avoid placing furniture next to heat sources such as radiators or fires. Be particularly careful with solid wood as the lack of humidity caused by heating can cause damage such as warping.

### **Safety Instructions**

Never drag furniture when moving it, always lift it.

Periodically check all fixings to ensure none have come loose and re-tighten where necessary.

Please take care when handling or moving the furniture as careless handling may cause damage or injury.

Furniture can be dangerous if incorrectly installed. Assembly should be carried out by a competent person. No liability will be accepted for damage or injury caused by incorrectly installed or assembled furniture.

It is recommended that before moving heavy objects to a new location they are completely dis-assembled to avoid personal injury or damage to the furniture. Please be careful to retain all fittings when doing this.

**PLEASE KEEP THESE INSTRUCTIONS FOR FUTURE REFERENCE**