

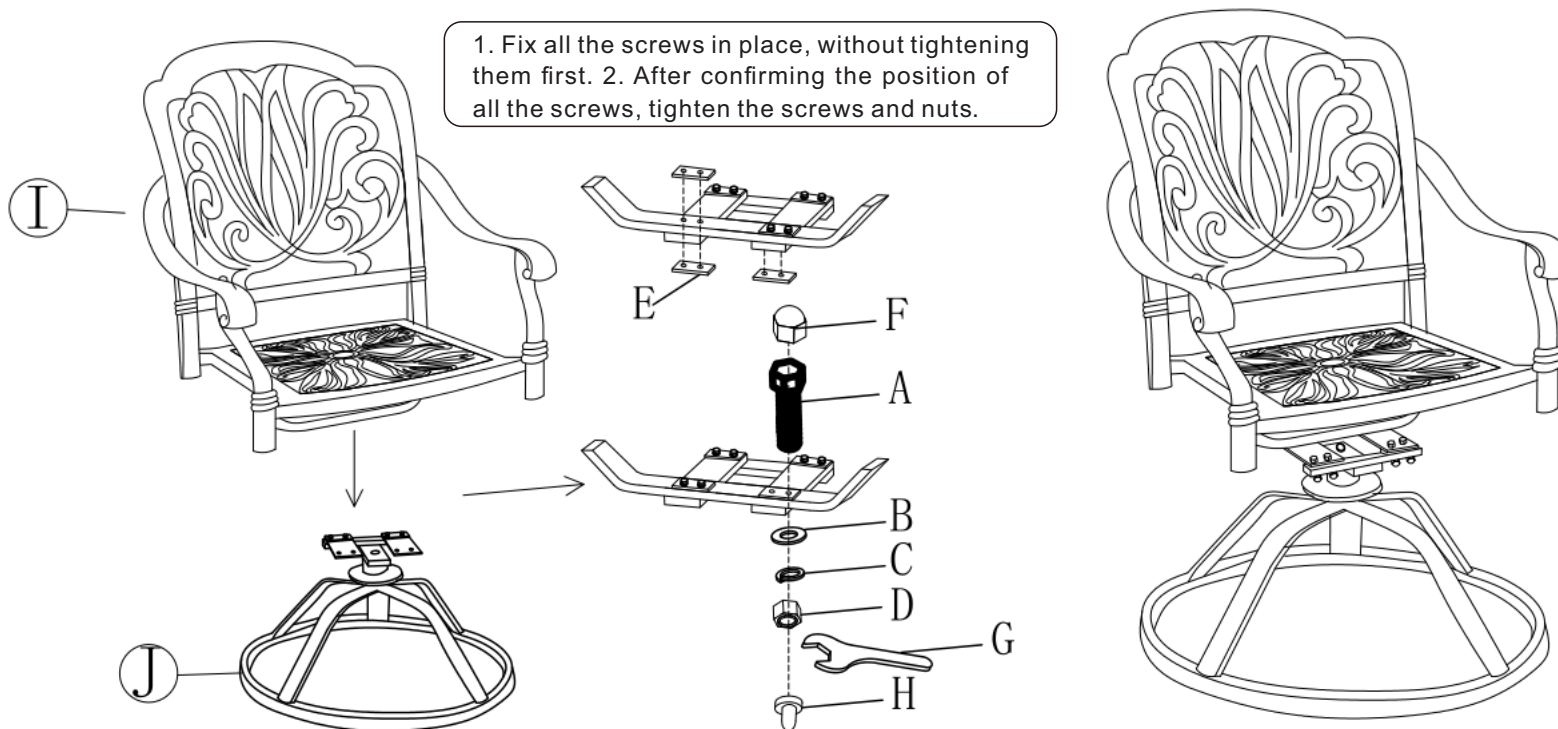









ASSEMBLY INSTRUCTION

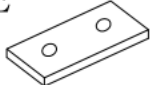

1. Fix all the screws in place, without tightening them first. 2. After confirming the position of all the screws, tighten the screws and nuts.



Service Contact: service@alipuinc.com
 Website: <https://clihome.net/>
 Contact Phone Number: 303-747-4421

 4PCS	 4PCS	 4PCS	 4PCS	 4PCS	<h1>J</h1>									
 4PCS	 1PCS	 4PCS PE cap	 1PCS	 1PCS										