

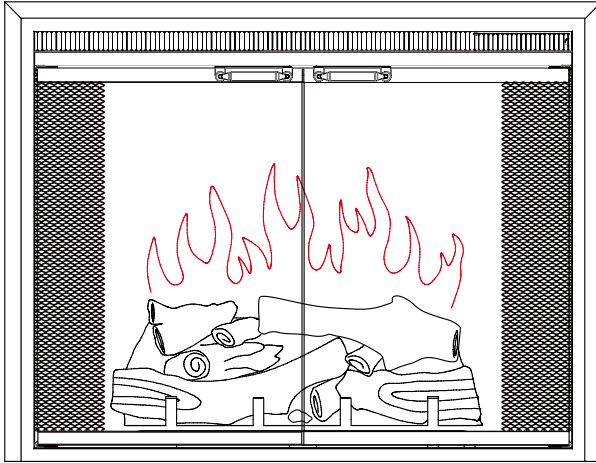

Electric Fireplace Insert

Model Number: (EF42B, EF43B, EF44B, EF45B, EF302B)

OWNER'S MANUAL



 WARNING	<p>Read and understand this entire owner's manual, including all safety information, before plugging in or using this product. Failure to do so could result in fire, electric shock, or serious personal injury.</p>
 CAUTION	<p>Keep this owner's manual for future reference. If you sell or give this product away, make sure this manual accompanies this product.</p>

DO NOT RETURN!

Contact our customer service team for help first.

service2@richenchina.com

Call: 909-206-6608

CONTENT

1. Important Safety Information	1
2. Technical Specifications	4
3. Before Installation	5
4. Installation Instruction	6
5. Operation Instruction	10
5a. Manual Control Panel	10
5b. Remote Control	12
6. Care and Maintenance	14
7. Limited Warranty	15
8. Troubleshooting Guide	16
9. Schematic Diagram	18

1. IMPORTANT SAFETY INFORMATION

When using electrical appliances, basic precautions should always be followed to reduce the risk of fire, electric shock, and injury to persons, including the following:

- **Read all instructions before using this appliance.**
- **Use this appliance only as described in this manual. Any other use not recommended by the manufacturer may cause fire, electric shock, or injury to persons.**
- **DO NOT use outdoors.**
- **NEVER** use this appliance in **bathrooms, laundry rooms**, or any other location where the appliance could fall into a **bathtub** or **pool**, **become damp**, or **come in contact with water**.
- **For residential use only. NOT for commercial use!** Any commercial or public use of this appliance **voids all warranties**, and could cause **injury**.
- This product is **not intended** to be a **primary heat source**. It is for **supplemental heat only**.
- **Do not** locate the appliance immediately **below** a fixed socket outlet.
- This appliance **must** be **grounded**.
- **DO NOT** operate any appliance with a **damaged cord or plug** or after the **appliance malfunctions**, has been **dropped** or **damaged in any manner**. Discard appliance, or return to authorized service facility for examination and/or repair.
- This appliance is **hot when in use**. To avoid burns, **DO NOT** let bare skin touch **hot** surfaces. Keep **combustible materials**, such as furniture, pillows, bedding, papers, clothes, and curtains at least **3 feet (0.9m)** from the **front of the appliance**.
- **Extreme caution** is necessary when any appliance is used by or near **children** or **invalids** and whenever the appliance is left **operating and unattended**.
- **DO NOT insert** or **allow foreign objects** to **enter any ventilation or exhaust opening**, as this may cause **electric shock** or **fire**, or **damage the appliance**.

- To prevent a possible fire, **DO NOT** block air intakes or exhaust in any manner. Doing so could cause a **fire**. **DO NOT** use on soft surfaces, like a bed, where openings may become blocked.
- As the appliance has **hot and arcing or sparking parts inside**. **DO NOT** use it in areas where **gasoline, paint, or flammable liquids** are used or stored.
- **AVOID FIRE!** Regularly inspect all air vents to make sure they are free from dust, lint, or other blockage. **Unplug the unit** and clean with a **vacuum ONLY**. **DO NOT** rinse or get wet.
- **DO NOT USE** this appliance with any **solid state speed control devices**.
- **Risk of electric shock! DO NOT OPEN!** No user-serviceable parts inside!
- **NEVER modify this appliance**. Doing so could result in personal **injury** or property **damage**. Modification of this fireplace **completely voids all warranties**.
- **NEVER** leave this appliance unattended. **To disconnect** appliance, **ALWAYS turn controls to "OFF"** then remove plug from outlet or turn off circuit when not in use.
- **ALWAYS** turn this appliance off before unplugging it from the outlet.
- **To prevent** a possible **fire, do not burn wood** or other materials **in this appliance**.
- **ALWAYS disconnect** this unit from the **power supply before** performing any assembly or cleaning, or before relocating the electric fireplace.
- **Always use** properly grounded, **fused** and polarized outlets.
- **Always use ground fault protection** where required by electrical code.
- **Avoid use** of an **extension cord** because an extension cord may overheat and cause a fire. However if you have to use an extension cord, the cord should be **No.14 AWG minimum size** and rated to not less than 1875watts.
- **NEVER** plug this appliance into an outlet that is **old, cracked**, or has any **loose wires or connections**. Plugging this appliance into a faulty outlet could result in **electric arcing** within the outlet that could cause the **outlet to overheat or catch fire**.
- **DO NOT** run **power cord** under carpeting. **DO NOT** cover power cord

with throw rugs, runners, or similar coverings. **DO NOT** route power cord under furniture or appliances. Arrange power cord **away from traffic** area, and where it will not be tripped over.

- **ALWAYS** check your appliance cord and plug connections with **each use!**
 - A. **MAKE SURE** the plug fits tight in the outlet! Faulty wall outlet connections or loose plugs can cause the outlet to overheat.
 - B. **Appliances draw more current** than small appliances. **Overheating** may occur even if it has not occurred with the use of other appliances.
 - C. During use **check frequently** to see if the **plug outlet** is **HOT!** If the outlet or faceplate is **HOT, discontinue use immediately** and have a qualified electrician inspect and/or replace the faulty outlets.
- **SAVE THESE INSTRUCTIONS.**



Safety Alert Key:

- **WARNING!** Indicates a hazardous situation which, if not avoided could result in death or serious injury.
- **CAUTION!** Indicates a hazardous situation which, if not avoided, could result in minor or moderate injury

2. TECHNICAL SPECIFICATIONS

Electric Specifications

Model	Volt	Watt (min/max)	Hz	BTU(max)	Amp	Heating Area(max)
EF42-45B EF302B	120	750/1500	60	5000	12.5	400 square feet

Product Dimensions

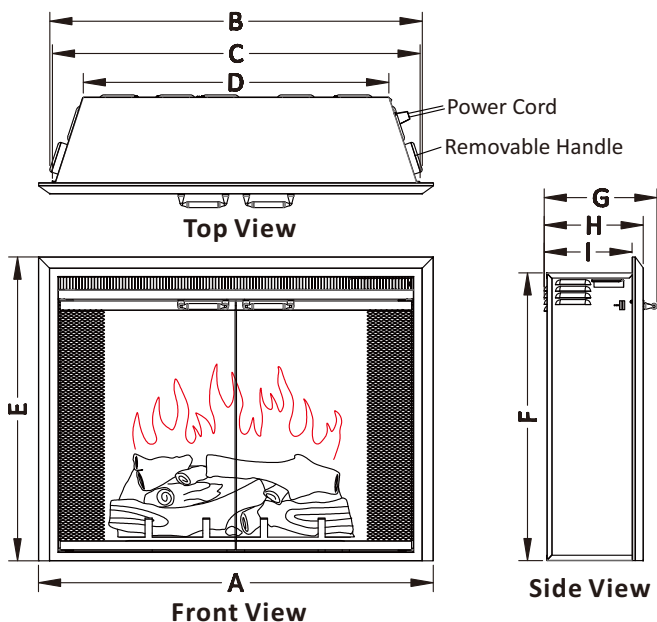

Model	unit	A	B	C	D	E	F	G	H	I
EF42B	inch	24 13/16	22 13/16	21 7/8	16 15/16	21 7/16	20 1/16	10	8 25/32	7 51/64
	mm	630	580	556	430	545	509	254	223	198
EF43B	inch	27 15/16	26	25 1/16	20 1/16	24 5/8	23 3/16	10	8 25/32	7 51/64
	mm	710	660	636	510	625	589	254	223	198
EF44B	inch	31 7/8	29 15/16	29	24	24 5/8	23 3/16	10	8 25/32	7 51/64
	mm	810	760	736	610	625	589	254	223	198
EF45B	inch	35 1/16	33 1/16	32 1/8	27 3/16	27	25 9/16	10	8 25/32	7 51/64
	mm	890	840	816	690	685	649	254	223	198
EF302B	inch	35 1/16	33 1/16	32 1/8	27 3/16	22 7/16	21	10	8 25/32	7 51/64
	mm	890	840	816	690	570	534	254	223	198

3. BEFORE INSTALLATION

WARNING! DO NOT operate or use this Electric Fireplace if it is damaged or has malfunctioned or any part has been under water. Immediately call a qualified service technician to inspect and to replace any part of the electrical system if necessary. Keep plastic wrapping away from children.

Note:

- Keep the packaging (carton, poly bag, polystyrene, etc.) for future transportation and/or storage.
- **If the unit needs to be returned, please make sure all the spare parts are packed inside, door handles are taken off, and packed the same as the original packing.**

Check Spare Parts

- Open the packaging carefully and remove the polystyrene.
- Check the spare part list below to verify all parts have been received.
- Carefully check if any damages that may have for the insert or spare parts.

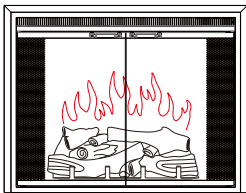

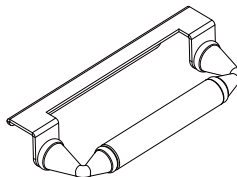

Firebox (1 pc)



Door Handle (2 pcs)



ST4*10 Screw (4 pcs)

 <p>Remote Handset (1 pc)</p>	 <p>AAA Battery (2pcs)</p>	 <p>Owner's Manual (1 pc)</p>
--	---	--

Function Testing

Please refer to section 5a. Manual Control Panel and 5b. Remote Control to test the appliance first before installation. **Should any defects found, please contact service team for help. E-mail service2@richenchina.com or call 909-206-6608 during 9:00 to 17:00 PST from Monday to Friday.**

4. INSTALLATION INSTRUCTIONS

ALWAYS unplug this fireplace heater before assembly or cleaning, or before relocating. Failure to do so could result in electric shock, fire or personal injury.



KEEP drapery and other furnishings at least 3ft /0.9m from the front and sides of the electric fireplace.

AFTER installation, ensure that there is $\geq 0.004\text{m}^2$ ventilation area between inside and outside of fireplace mantel.

Tools Required

A Phillips screwdriver

Locating the Appliance

Your new electric fireplace may be installed virtually anywhere in your home. However, when choosing a location, ensure that the general instructions for safety are followed.

- For best results, install out of direct sunlight, water or very damp air.

- Power supply service must be installed within proximity of electric fireplace prior to finishing avoiding reconstruction.

Minimum Clearance to Combustibles

Sides.....	0 inch
Floor.....	0 inch
Back.....	0 inch
Top (shelf or TV).....	8 inch min
Front.....	36 inch

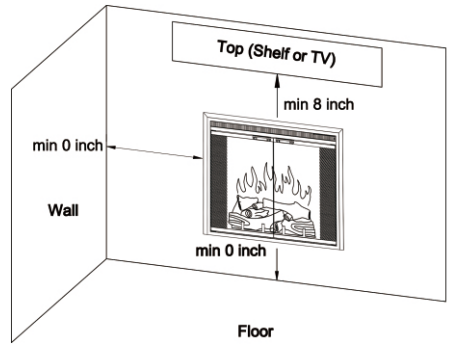

WARNING! Risk of Fire!

Keep electrical cords, drapery, furnishings or other combustibles at least 3ft. (0.9 m) from the front of the electric fireplace.

Electrical Supply Circuit Requirements

- Plan the location of the appliance so that it will have adequate electric power. A 15 AMP, 60Hz circuit is required for 120V installation. The appliance should ideally be located close to a suitable main socket to enable power connection.

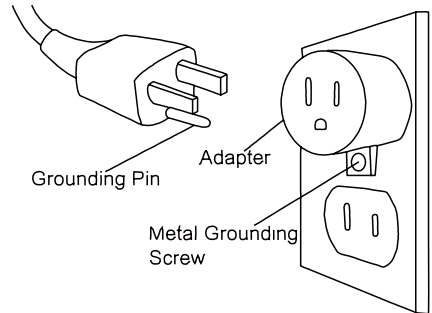

- The power cord is 6ft long and locates on the right side of the unit. If the cord is found not long enough to reach the outlet, a grounded extension could be run from an existing socket outlet but a minimum size 14 AWG with a minimum rating 1875W would be recommended, and it should not be longer than 7ft and 10 31/64”.
- Always make sure the outlet is in good condition and the plug is not loose. **NEVER** exceed the maximum amperage of the circuit.

Note:

- This model can **NOT** be hard wired.
- **THE PLUG MUST BE PLUGGED VERY TIGHTLY. DO NOT plug other appliances onto the same circuit.**

Install the Door Handles

Open the door and fix the handles with 2pcs ST4x10 screws on each side.

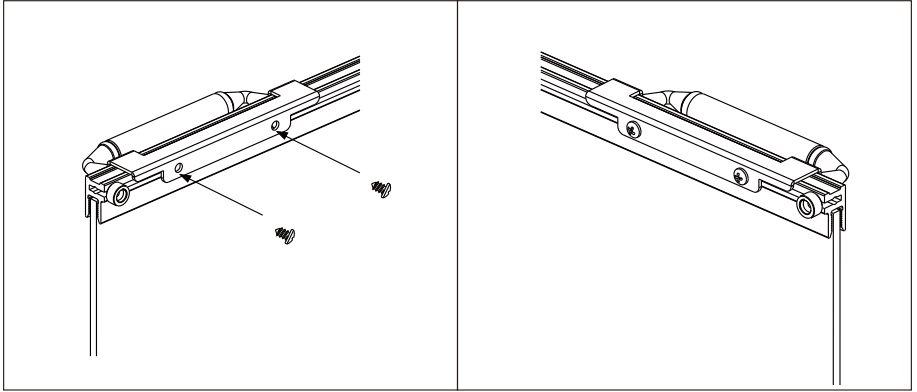

Insert into the Opening

The product can be built into a framing, an existing fireplace opening, a custom mantel or a cabinet. The opening depth $8 \frac{3}{16}$ " is suggested for better ventilation.

It is recommended of the clearance from the top of the appliance to the bottom of TV to be kept 8" at least if there is a TV above. No special venting would be required on either side.

The desired dimension should follow below diagram and table.

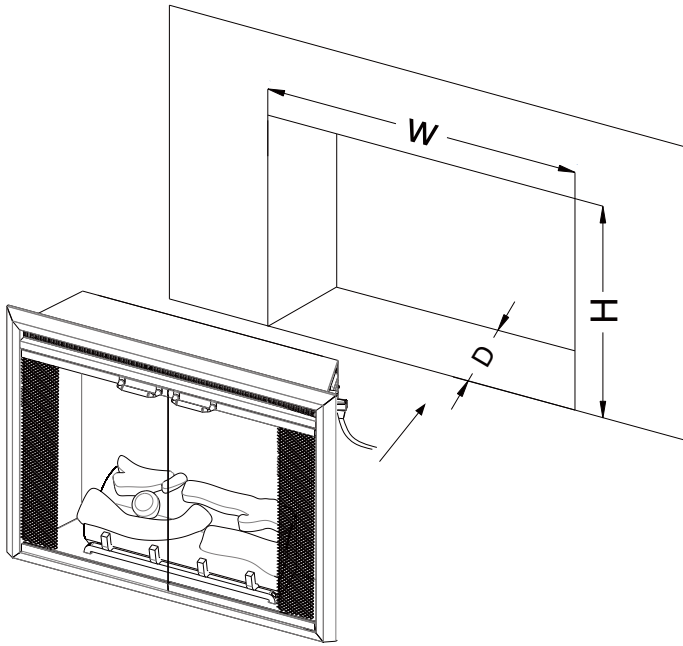

Opening dimensions ranges					
SKU	Unit	Width	Height	Depth (min)	Depth (suggest)
EF42B	inch	22 ¹³ / ₁₆ - 24	20 ¹ / ₄ - 21 ¹ / ₄	7 ¹³ / ₁₆	8 ³ / ₁₆
	mm	580-610	515-540	198	206
EF43B	inch	26 - 27 ³ / ₁₆	23 ⁷ / ₁₆ - 24 ⁷ / ₁₆	7 ¹³ / ₁₆	8 ³ / ₁₆
	mm	660-690	595-620	198	206
EF44B	inch	29 ¹⁵ / ₁₆ - 31 ¹ / ₈	23 ⁷ / ₁₆ - 24 ⁷ / ₁₆	7 ¹³ / ₁₆	8 ³ / ₁₆
	mm	760-790	595-620	198	206
EF45B	inch	33 ¹ / ₁₆ - 34 ¹ / ₄	25 ¹³ / ₁₆ - 26 ³ / ₄	7 ¹³ / ₁₆	8 ³ / ₁₆
	mm	840-870	655-680	198	206
EF302B	inch	33 ¹ / ₁₆ - 34 ¹ / ₄	21 ¹ / ₄ - 22 ¹ / ₄	7 ¹³ / ₁₆	8 ³ / ₁₆
	mm	840-870	540-565	198	206

Note: The removable handles on both sides could be removed if the existing opening is found a little bit narrow.

5. OPERATING INSTRUCTIONS



Read and understand this entire owner's manual, including all safety information, before plugging in or using this product. Failure to do so could result in electric shock, fire, serious injury, or death.



WARNING! Do not operate the unit if it is damaged or has malfunctioned. If you suspect the unit is damaged, call a qualified service technician to inspect and replace any part of the electrical system if necessary.

5a. Manual Control Panel

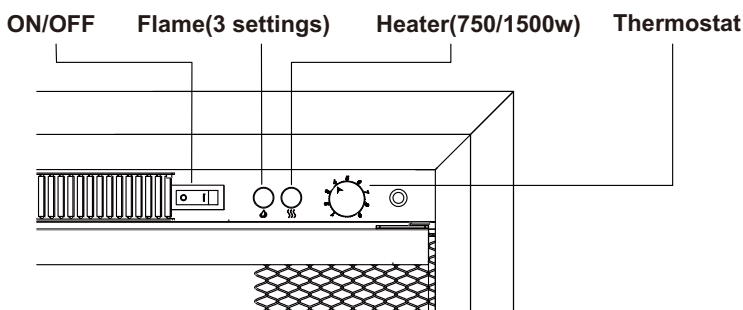

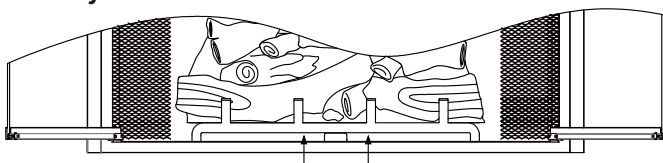

Note: When the heater is first turned on, a slight odor may be present. This is normal and should not occur again unless the heater is not used for a long period of time.

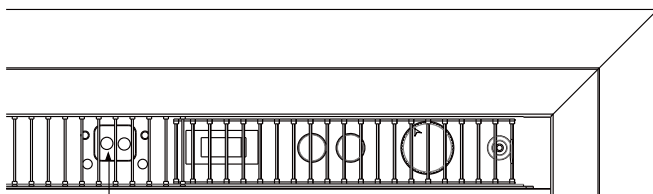

Heating Indicator Light



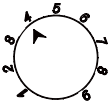

Heating Indicator Light & Remote Receiver



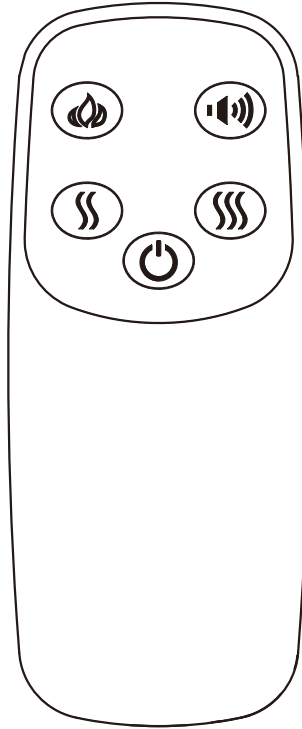

BUTTON	NAME	FUNCTION
	POWER SWITCH	<p>Turn the main power switch on. A long “beep” sound will be heard when the switch is turned at ON Position “I”.</p> <p>Note: The remote control will lost the memory for function settings when the switch is turned at OFF Position “O”.</p>
	FLAME	<p>The flame will be cycled from Flame A – Flame B – Flame C – Flame Off.</p> <p>Flame A: full bright flame + little blue Flame B: full bright flame Flame C: half bright flame</p>
	HEATER	<p>The heater will be cycled from Low – High – Heater Off. The indicator light on left to Power Switch (see the last picture on last page) will illuminate when the heater is turned on. The indicator light will go out within 10s.</p> <p>Low: (●○) High: (●●)</p> <p>Note:</p> <ol style="list-style-type: none"> 1. Heater can be used without flame. 2. The heater will work when the temperature set by thermostat is higher than room temperature. 3. The Fan works about 10s ahead of the heater, and stops about 10s later than the heater. 4. The indicator light in the lower fuel bed (see the first picture on last page) always illuminates when heater is on.
	THERMOSTAT	<p>Turn it to setting 9 first and when the room has reached a desired level, turn the rotary switch counterclockwise slowly until the thermostat just ‘clicks’ off. The thermostat will then maintain the room at this selected level. To increase the temperature, turn the rotary switch clockwise to a higher setting.</p>

5b. Remote Control

Note: Remote control can be used only when the main power switch is on. Aim the remote control at the remote receiver (see picture on page 10) which is on the left of the main power switch



BUTTON	TITLE	FUNCTION
	POWER	The power button will enable the unit in standby mode. This will turn off all functions and hold the settings in memory, press the power button again will turn on the unit to previous settings. For the first time use, Flame A will be turned on.

	FLAME	The flame will be cycled from Flame A – Flame B – Flame C – Flame Off.
	LOW HEAT	To turn on the heater on half heat setting or turn off the heater.
	HIGH HEAT	To turn on the heater on full heat setting or turn off the heater.
	CRACKLING	To turn on the crackling and cycle through high crackling sound – normal crackling sound – low crackling sound - high crackling with wind sound – normal crackling with wind sound – low crackling with wind sound- off.

Temperature Limiting Control

This heater is equipped with a Temperature Limiting Control. Should the heater reach an unsafe temperature, the heater will automatically turn OFF. To reset:

- Unplug the power cord from the outlet.
- Turn the Power Switch on the CONTROL PANEL to OFF. Wait at least 5 minutes.
- Inspect the fireplace to make sure no vents are blocked, or clogged with dust or lint. If they are, use a vacuum to clean the vent areas.
- With the Power Switch in the OFF position, plug the power cord back into the outlet.

If it switches off again, UNPLUG THE HEATER RIGHT AWAY! Have the outlets, wiring, and breaker box inspected by a professional. Make necessary repairs before using the heater.

6. CARE AND MAINTENANCE

ALWAYS turn the heater **OFF** and unplug the power cord from the outlet before cleaning, performing maintenance, or moving this fireplace. Failure to do so could result in electric shock, fire, or personal injury.



NEVER immerse in water or spray with water. Doing so could result in electric shock, fire, or personal injury.

Risk of electric shock! DO NOT OPEN! No user-serviceable parts inside!

Cleaning

Metal:

- Buff using a soft cloth, slightly dampened with a citrus oil-based product.
- **DO NOT** use brass polish or household cleaners as these products will damage the metal trim.

Glass:

- Use a good quality glass cleaner and dry thoroughly with a paper towel or lint-free cloth.
- **NEVER** use abrasive cleansers, liquid sprays, or any cleaner that could scratch the surface.

Plastic:

- Wipe gently with a slightly damp cloth and a mild solution of dish soap and warm water.
- **NEVER** use abrasive cleansers, liquid sprays, or any cleaner that could scratch the surface.

Vents:

- Use a vacuum or duster to remove dust and dirt from the heater and vent areas.
- Clean the exterior of the fireplace with a slightly damp cloth or duster.

Maintenance

Electrical and Moving Parts:

- The fan motors are lubricated at the factory and will not require lubrication.

- Electrical components are integrated in the fireplace and are not serviceable by the consumer.

Storage:

- Store heater in a clean dry place when not in use.

Replacement parts:

- Use only replacement parts supplied by the manufacturer. Use of any other parts, or modifying the fireplace in any way, will void all warranties.
- No internal parts are replaceable or serviceable.

7. LIMITED WARRANTY

This warrants to the original purchaser that this product is free from defects in material and workmanship as of the date of purchase and that it will, under normal use and proper care, remain so for one year from the date of purchase. Missing or initially defective parts will be replaced free of charge during the period of this limited warranty. If parts are unavailable, comparable replacement or refund will be given. **The original dated sales receipt is required for all warranty claims.** This warranty does not cover damage which has occurred during transport from the point of purchase to the consumer's home. This warranty does not cover glass, light bulbs, batteries, transportation, labor, or other issues not associated with the manufacture of the product.

This product is for residential use only. Any and all commercial use of this product voids all warranties, and frees the manufacturer from all liability.

Read and understand all assembly and operating instructions, and all safety information and warnings, before use. The following will void this warranty: Damage caused from tampering with, modifying, or altering the fireplace insert in any manner; Damage due to incorrect assembly, improper care, misuse, or abuse; Damage from being used with the wrong power source; Water damage; Damage caused from this insert being used outdoors; Damage caused from this insert being used for excessive periods of time; Damage caused by the insert being used in a commercial application; Damage from use as a primary heat source; Other misuse or abuse not specifically listed herein.

This product is not intended to be used as a primary heat source. It is for supplemental heating purposes only.

8. TROUBLESHOOTING GUIDE

1. The remote does not work and the new unit we just got cannot be turned on.
 - 1) Make sure the main power switch on the top right behind the fence is on.
 - 2) There would be a long beep when the main power switch is turned on.
 - 3) If there is no beep, the connectors on the PCB board might be loosen, please contact service team for a checking instruction.
 - 4) If there is a beep and the control panel can be used but the remote is not working, the remote is not working either close or far, please contact service team for help.
2. My old unit no longer works, it cannot power on.
 - 1) Check the power cord to see if it is well.
 - 2) If the power cord is fine, check the wires behind the rocker switch to see if they are burned.
 - 3) If the wires are well, too, the PCB board might be broken and need to be replaced. Please contact service team for a replacement and instruction.
3. The heater does not work, it turns on for several seconds then shuts off itself.
 - 1) New product:
 - b. If yes, pull off the CN3 connector plugged on the PCB board. If the heater works, the button panel should be replaced.
 - c. If the heater still does not work after unplugging the CN3 connector, please contact service team for a further solution.
4. There is no air coming out when turn the heater on.
 - 1) New product:
 - a. Confirm if the air outlet feels warm or there is something getting red inside when the heater is turned on. If yes, the fan is stuck or the heat motor is not in right position.

- a. Turn the thermostat to 8 to see if the heater will work continuously.
 - b. If not, unplug the unit for a whole night.
 - c. If still not, contact service team for a checking instruction, the fan assembly should be checked.
- 2) Product has been used for some time:
- a. Open the top panel to check if the fan can move smoothly or the heater motor is well connected.
 - b. If not, check the heater connectors on PCB board. Unplug and replug all connectors to see if the heater will work.
5. The heater does not come back even the room is already cold.
Turn the thermostat to 8 to see if the heater will work continuously, for help.
6. The flame does not show up or flicker or a noise when turn it on.
Please contact service team for a checking instruction of the flame LED board connector, flame motor and spindle.
7. The front trim is out of shape, the remote is missed or the log is broken.
Please contact service team for a replacement and instruction. if yes, the sensor is malfunction, if not, please contact service team

9. SCHEMATIC DIAGRAM

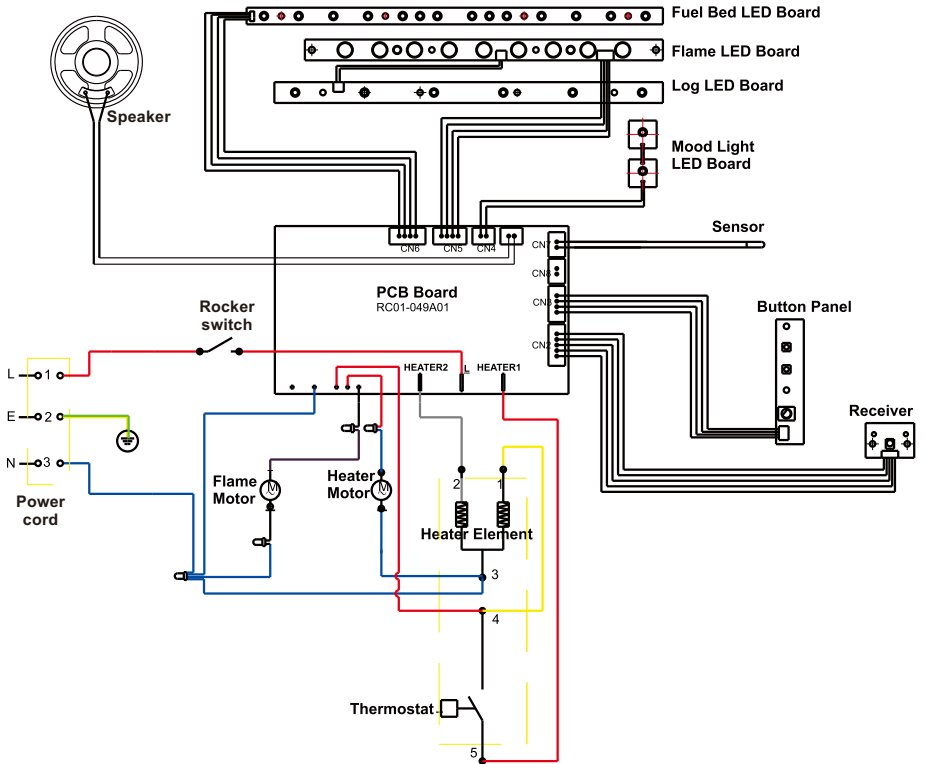

Ningbo Richen Electrical Appliance Co., Ltd.

Address: No.19, Yongdinghe Road, Xiapu, Beilun, Ningbo, P.R. China