

NOTE:

This brochure contains IMPORTANT safety info. Please read and keep for future reference.

MAINTAINANCE AND WARNING

- 1.Keep furniture away from heat sources.
- 2.Do not clean furniture with harsh cleaner or polishes.Do not use detergents,solvents,abrasives,spray packs or leather cleaner. Use non-color mild soa with warm water to clean spills(Mix 1:10 soap to water).
- 3.Do not place furniture under direct sunlight,material will possibly fade over time.
- 4.Do not use on site dry cleaning machine.Children should not climb or jump on the furniture.
- 5.Do not write on furniture that is not protectedby a padded barrier.
- 6.Not for commercial use,only for residential use.



Weight Limitation
100 LBS

EXPLOSIVE VIEW

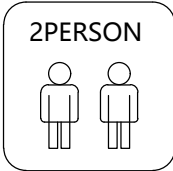
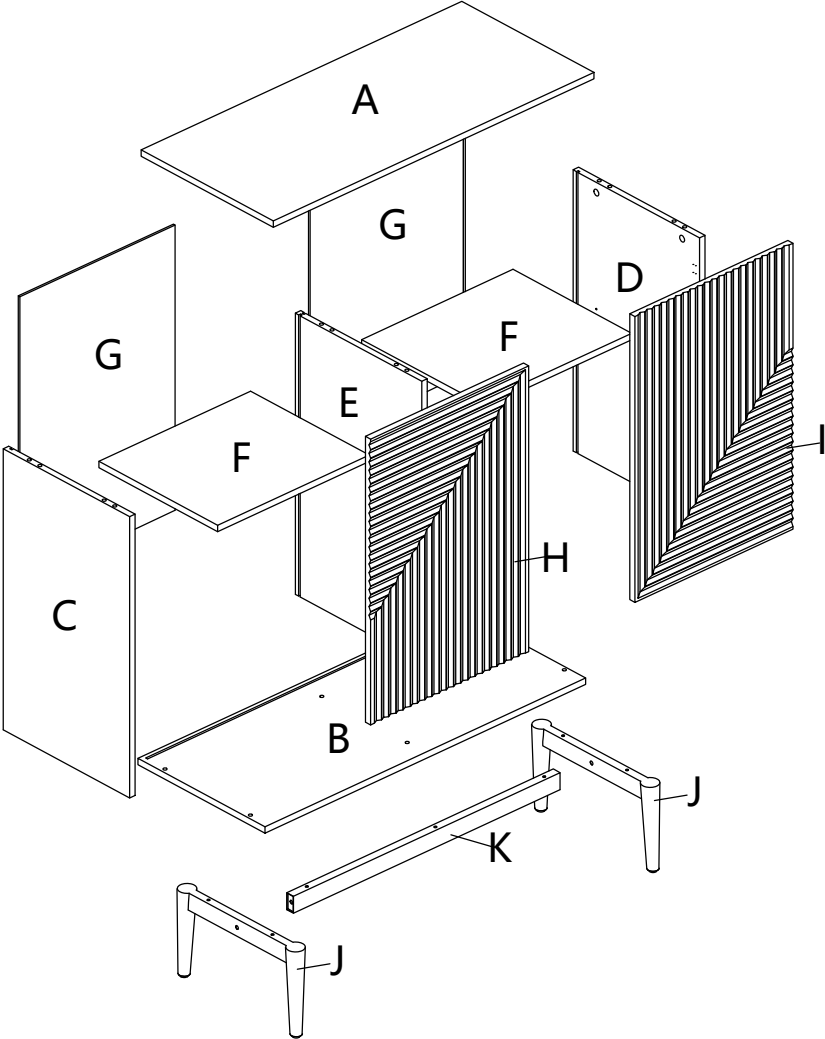





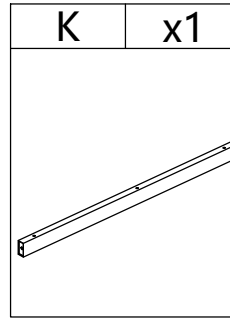
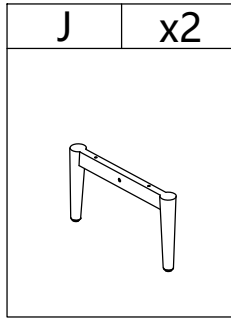
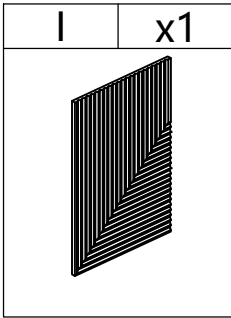
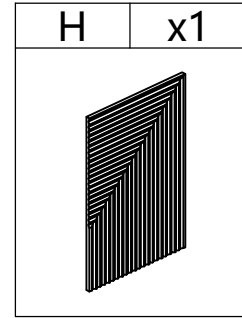
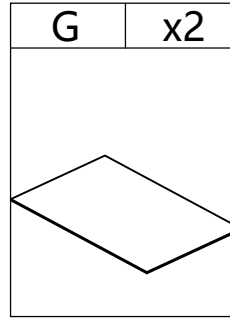
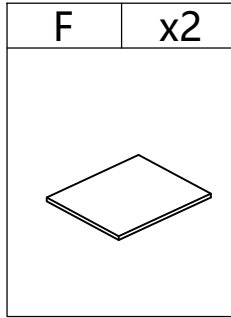
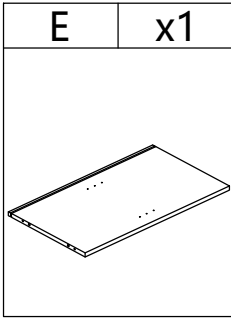
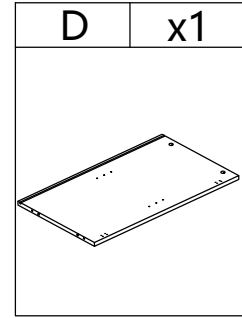
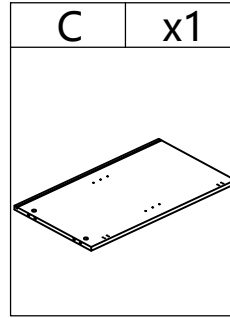
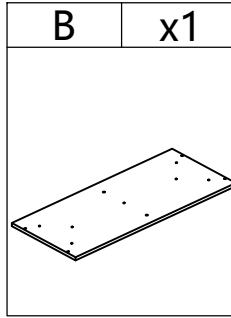
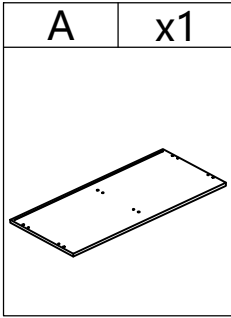

OVERVIEW







PARTS LIST













HARDWARE LIST

#1	x6	#2	x6	#3	x2	#4	x7	#5	x40	#6	x4
											
Ø6x35mm		M7x50mm		M6x40mm		M6x50mm		M3.5x14mm		M4x35mm	

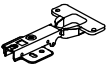
HARDWARE SPARE LIST

#1	x1	#2	x1	#3	x1	#4	x1	#5	x4	#6	x1
											
Ø6x35mm		M7x50mm		M6x40mm		M6x50mm		M3.5x14mm		M4x35mm	

HARDWARE LIST

#7	x12	#8	x6	#9	x6	#10	x8	#11	x4	#12	x2
											
ø8x30mm		ø15x11mm		ø20mm							
#13	x4	#14	x4	#15	x2	#16	x8				
											
		ø8x30mm									

TOOL LIST

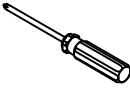
#17	x1	#18	x1
			
M4			

ASSEMBLY INSTRUCTIONS

STEP-1:

Insert wooden dowel #7 into the corresponding hole of top panel (A),screw bolt #1 into the corresponding hole of top panel (A),tighten bolt #1 with screwdriver #18.

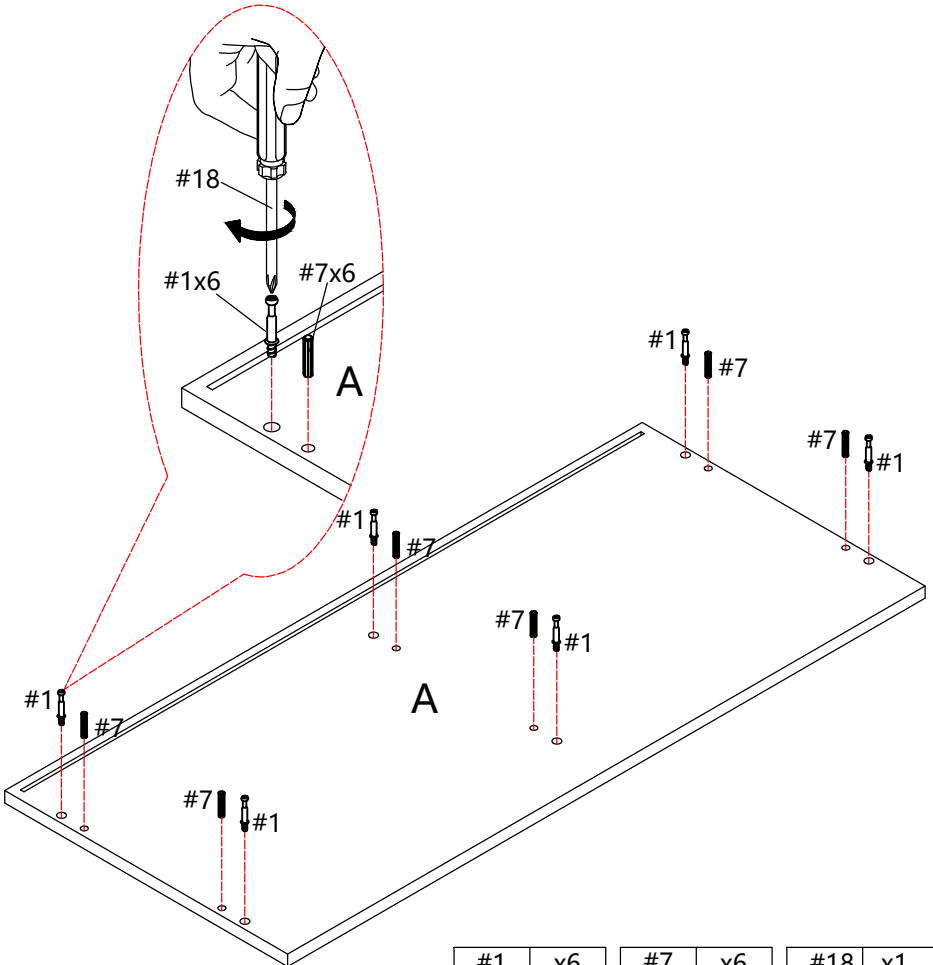

#1	x6
	
ø6x35mm	

#7	x6
	
ø8x30mm	

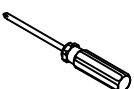
#18	x1
	

ASSEMBLY INSTRUCTIONS

STEP-2:

Insert panel (D)&(E)&(C) into top panel (A) as picture show, and then insert cam bolt #8 into the corresponding hole of panel (D)&(E)&(C), tighten cam bolt #8 with screwdriver #18, finally, stick paster #9 on the corresponding hole of panel (D)&(E)&(C).

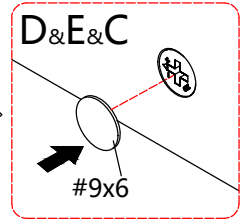
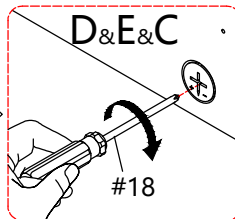
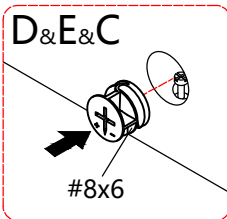
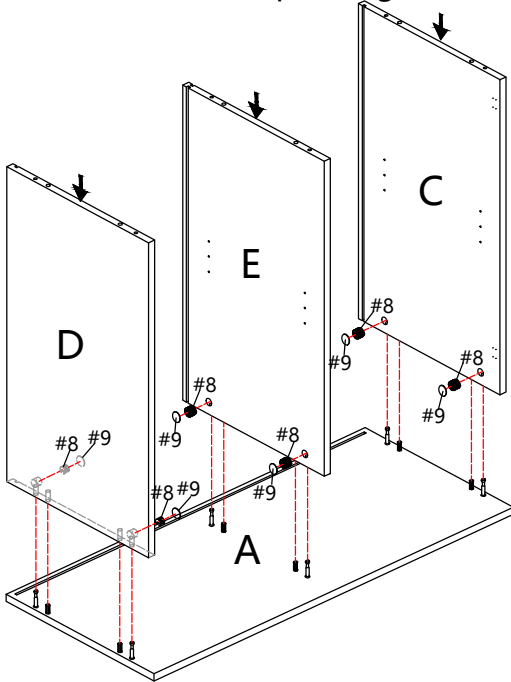

#8	x6
	
ø15x11mm	

#9	x6
	
ø20mm	

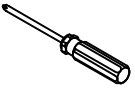
#18	x1
	

ASSEMBLY INSTRUCTIONS

STEP-3:

Carefully align and slide panel (G) into the groove along rear edge of pre-assemble unit at step 2, slide the panel (G) into the bottom, and the insert wooden dowel #7 into the corresponding hole of panel (D)&(E)&(C).

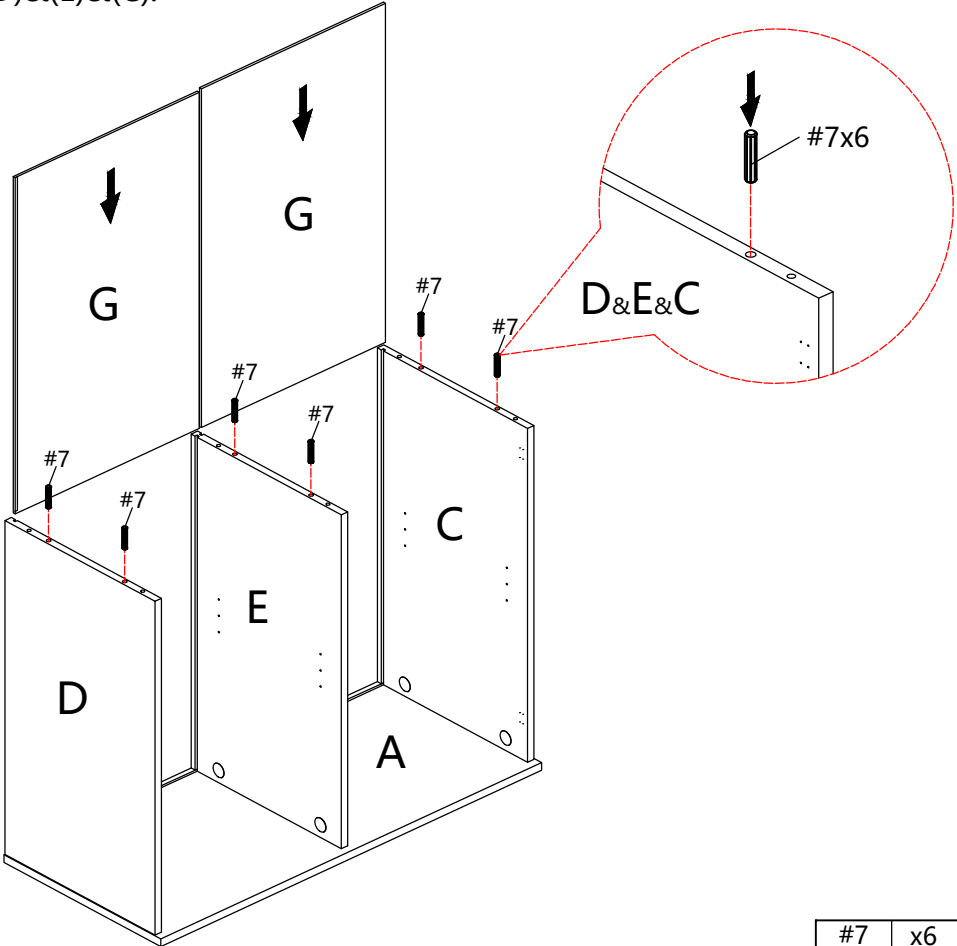



#7	x6
	
ø8x30mm	

ASSEMBLY INSTRUCTIONS

STEP-4:

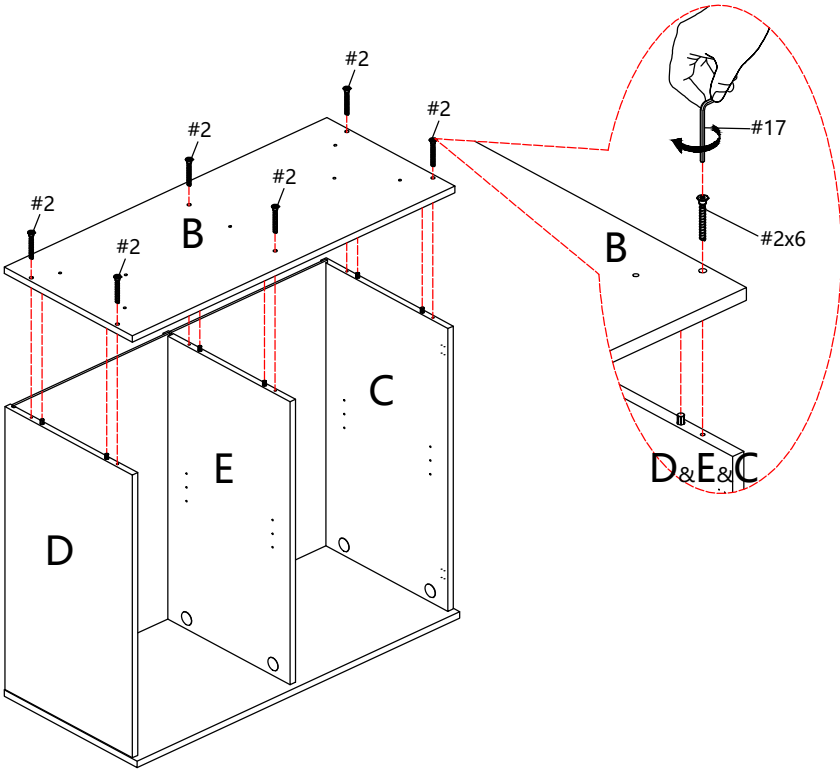
Use bolt #2 to attach bottom panel (B) to the corresponding hole of panel (D)&(E)&(C),tighten bolt #2 with allen key #17.



#2	x6
	
M7x50mm	

#17	x1
	
M4	

ASSEMBLY INSTRUCTIONS

STEP-5:

Use bolt #3 to attach leg (J) to rail (K), tighten bolt #3 with allen key #17.

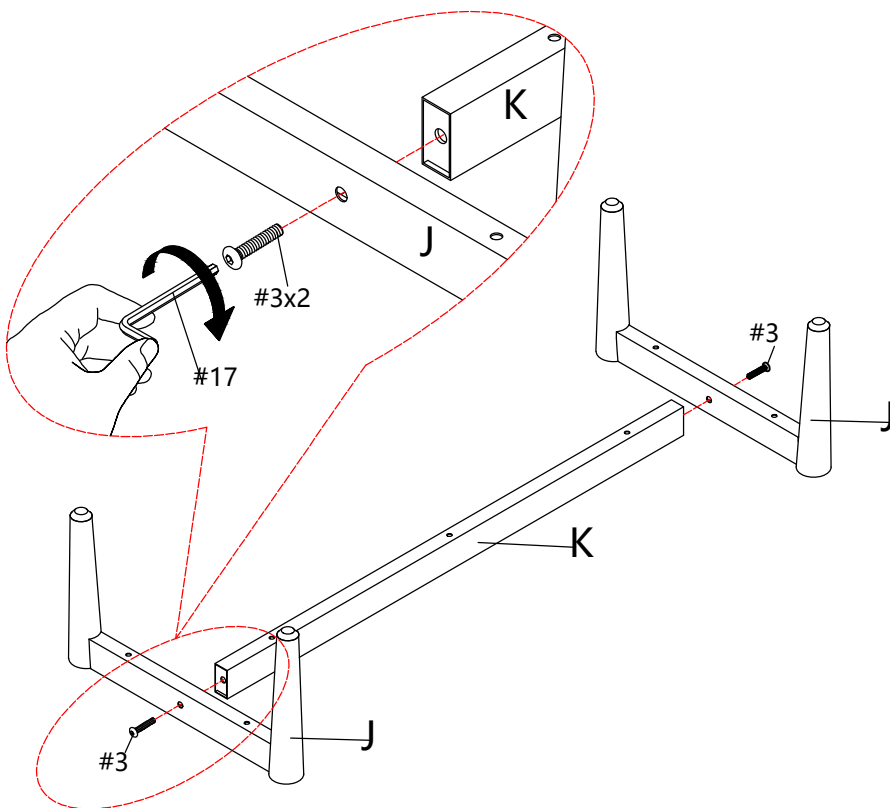

#3	x2
	
M6x40mm	

#17	x1
	
M4	

ASSEMBLY INSTRUCTIONS

STEP-6:

Use bolt #4 to attach preassemble leg (J)&(K) to the corresponding hole of bottom panel (B),tighten bolt #4 with allen key #17.

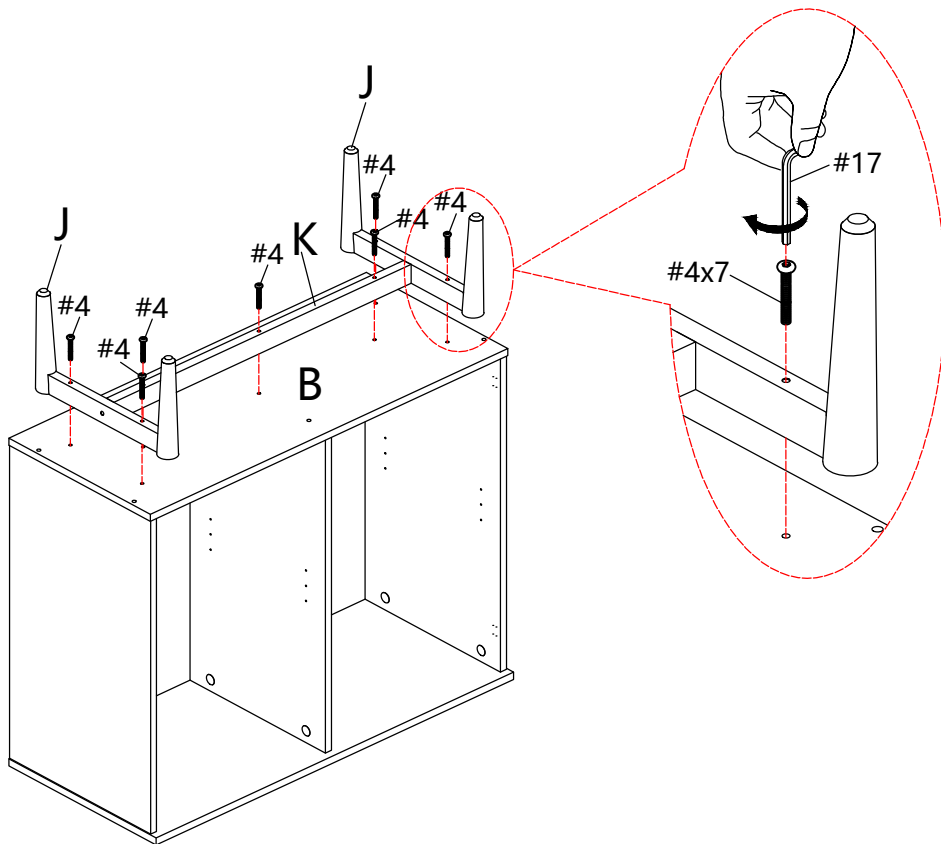

#4	x7
M6x50mm	

#17	x1
M4	

ASSEMBLY INSTRUCTIONS

STEP-7:

Attention:

Before the next step, adjust the feet of the locker to keep it level.

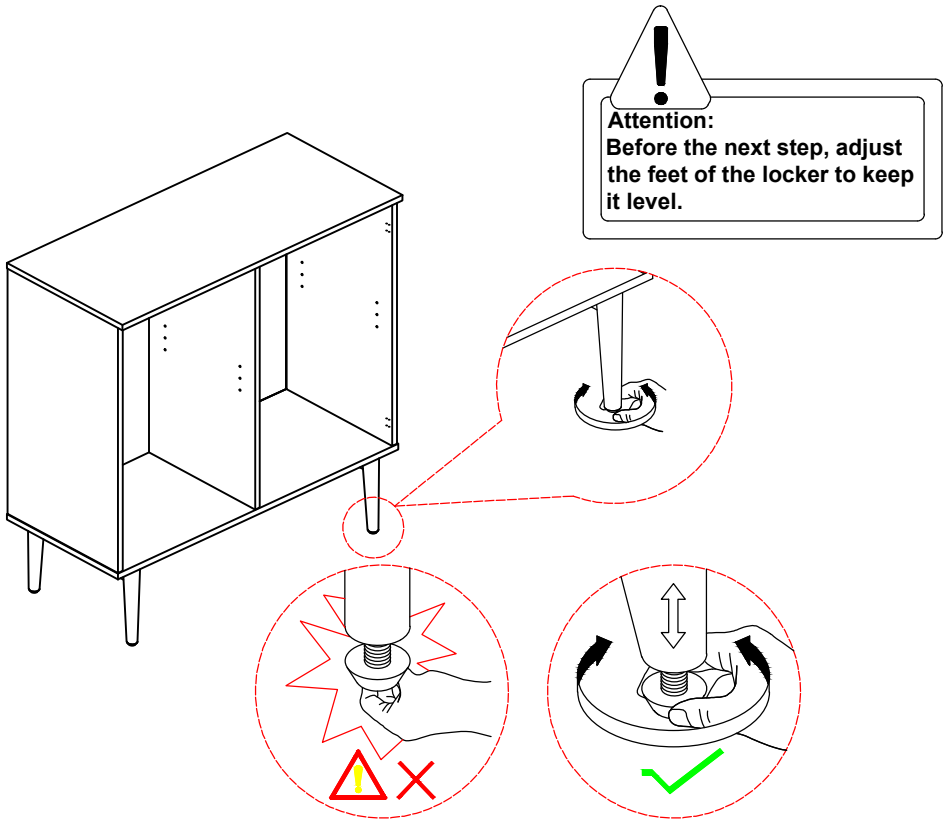



ASSEMBLY INSTRUCTIONS

STEP-8:

Use screw #5 to attach part #16 to bottom panel

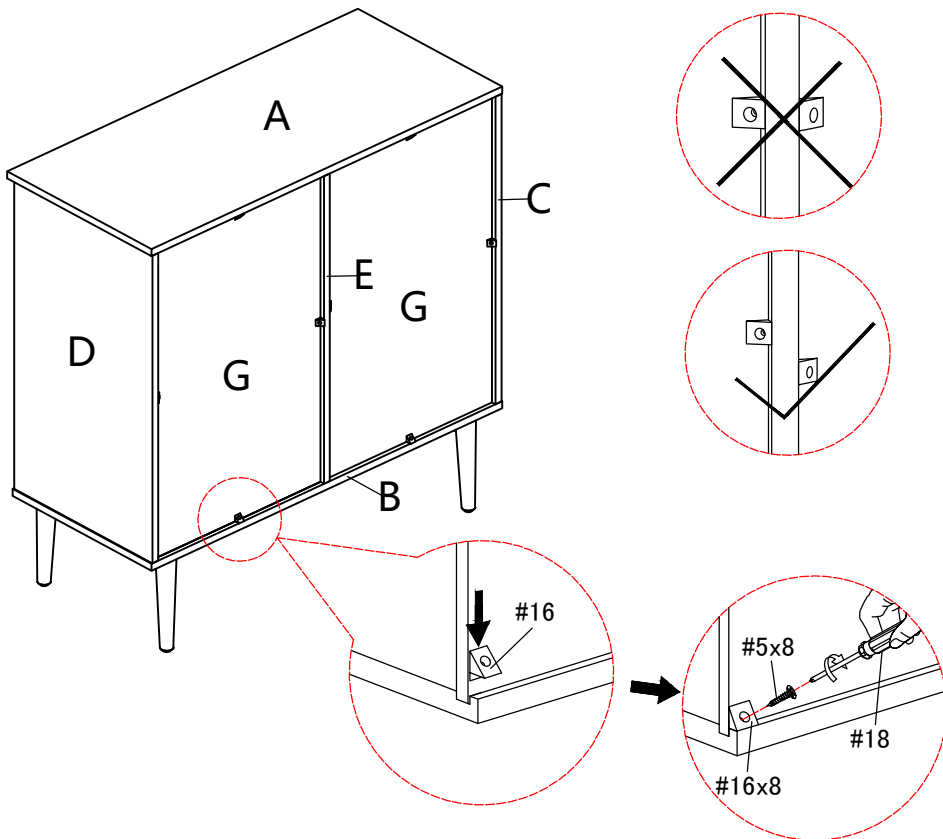
(A)&(B)&(C)&(D)&(E), tighten screw #5 with screwdriver #18.

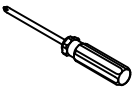

#5	x8	#16	x8	#18	x1
					
M3.5x14mm					

ASSEMBLY INSTRUCTIONS

STEP-9:

Insert shelf holder #10 into the corresponding hole of panel(C)&(D)&(E) and then attach adjustable shelf (F) to it.

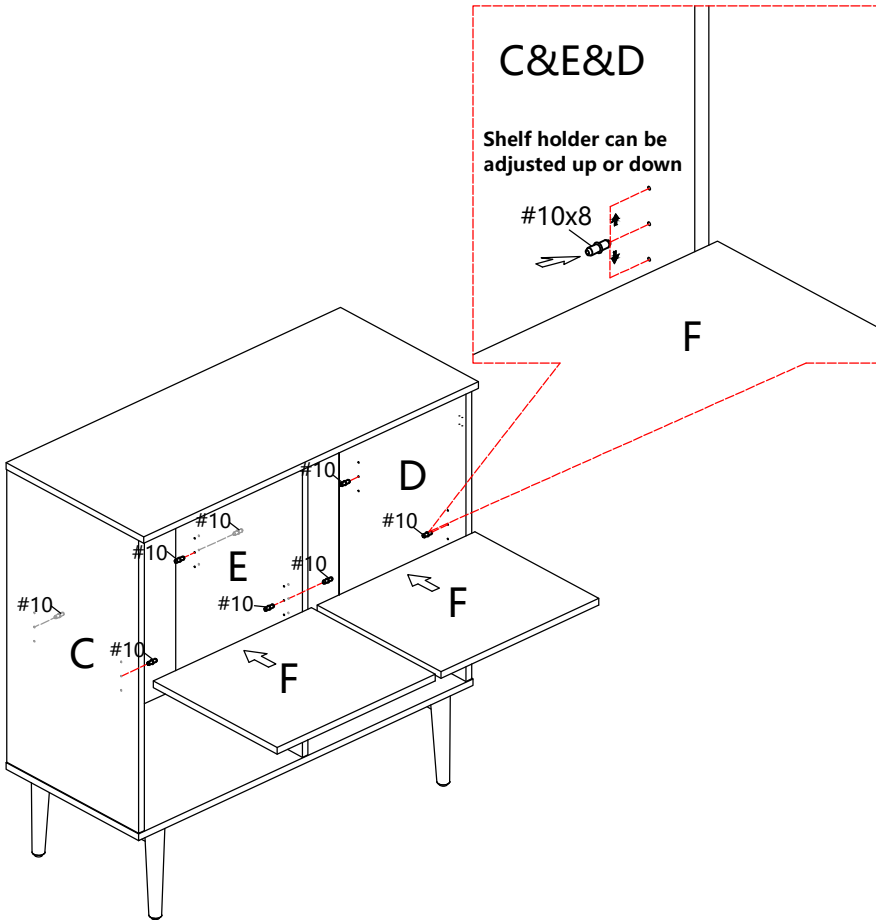

#10	x8

ASSEMBLY INSTRUCTIONS

STEP-10:

Use screw #5 to attach hinge #11 to door (I)&(H),tighten screw #5 with screwdriver #18.

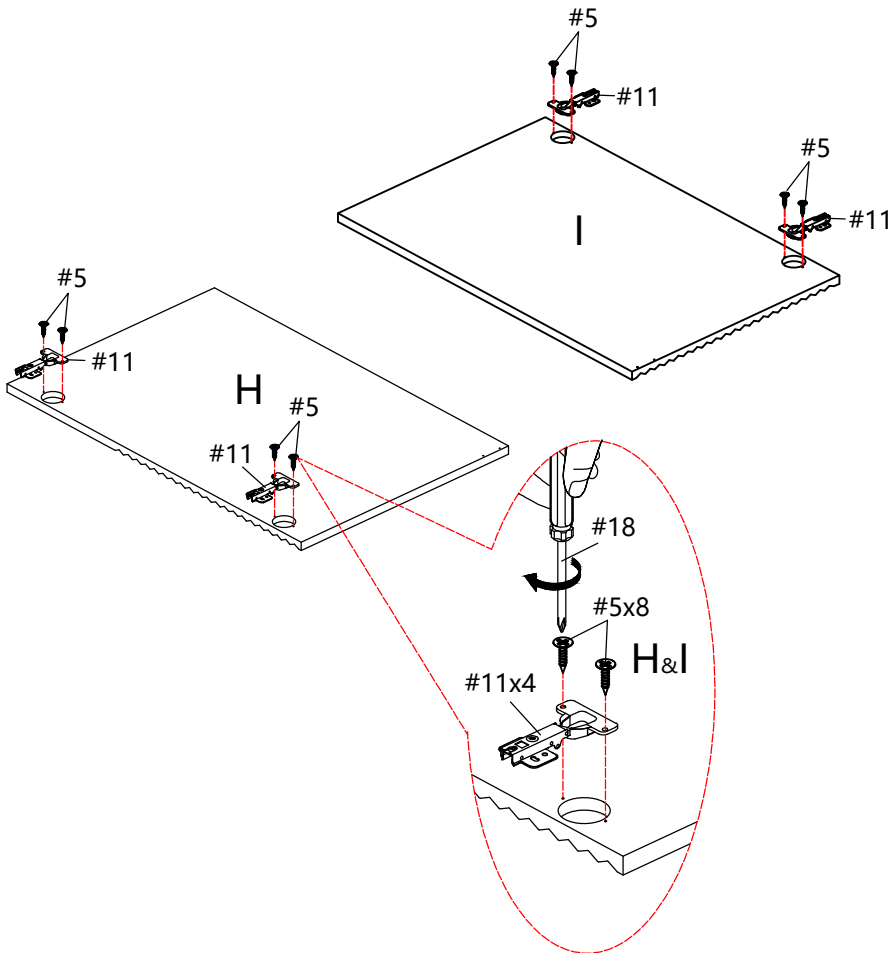

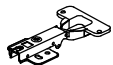
#11	x4
	

#5	x8
	
M3.5x14mm	

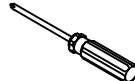
#18	x1
	

ASSEMBLY INSTRUCTIONS

STEP-11:

Use screw #5 to attach preassemble hinge #11 to panel (C)&(D), tighten screw #5 with screwdriver #18.

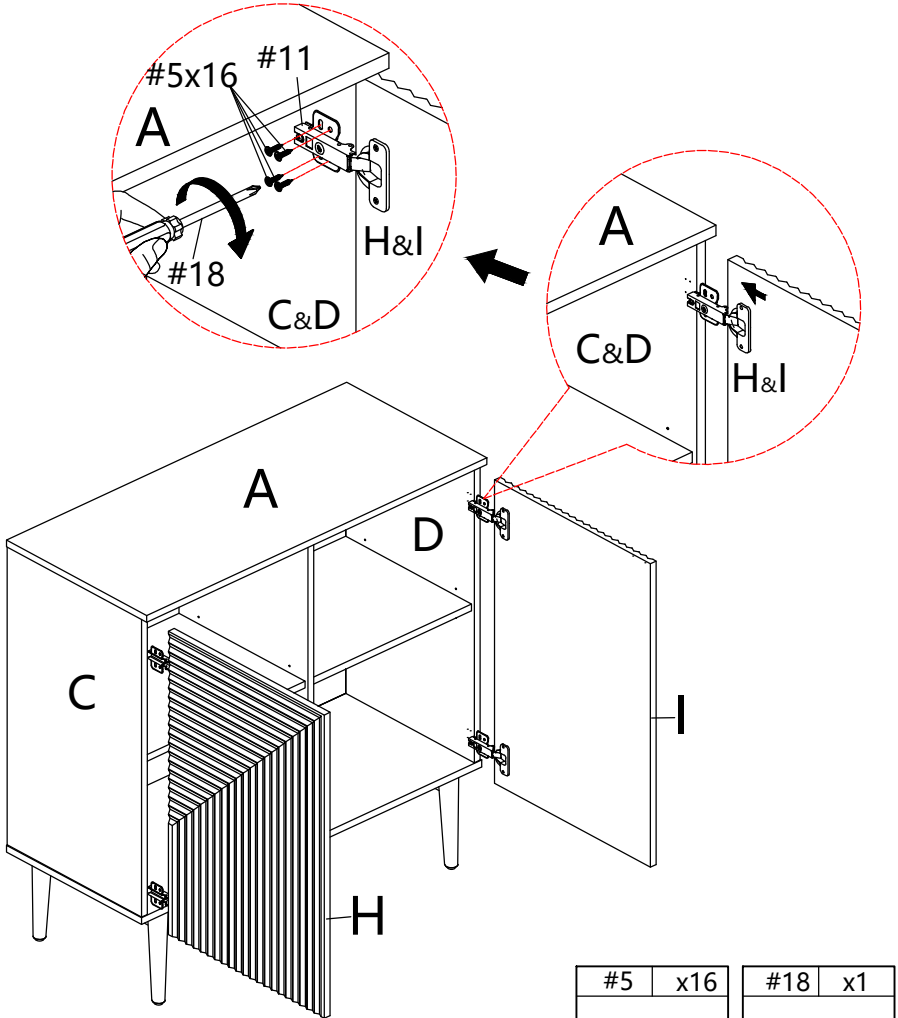

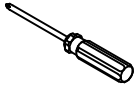
#5	x16	#18	x1
			
M3.5x14mm			

ASSEMBLY INSTRUCTIONS

Concealed hinges are three-way adjustable:

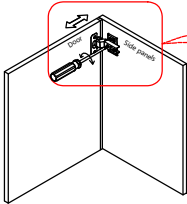

Horizontal
by screw adjustment!

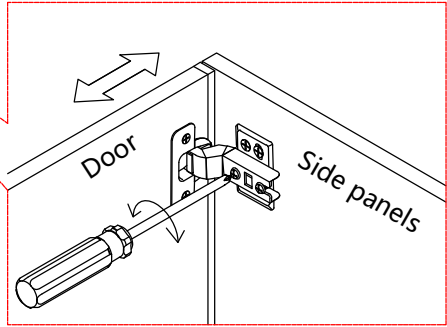

Concealed hinges are three-way adjustable:

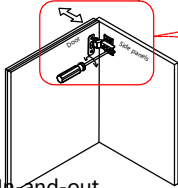

In-and-out
by loosening the hinge arm
mounting screw or via cam
adjustment!

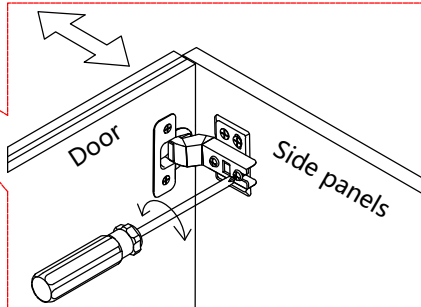

Concealed hinges are three-way adjustable:

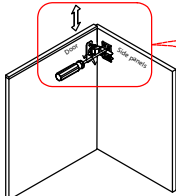

Vertical via slots in
the mounting plate
or via cam adjustment!

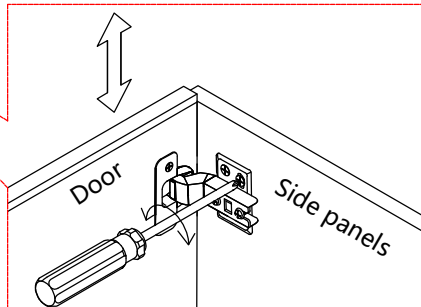



ASSEMBLY INSTRUCTIONS

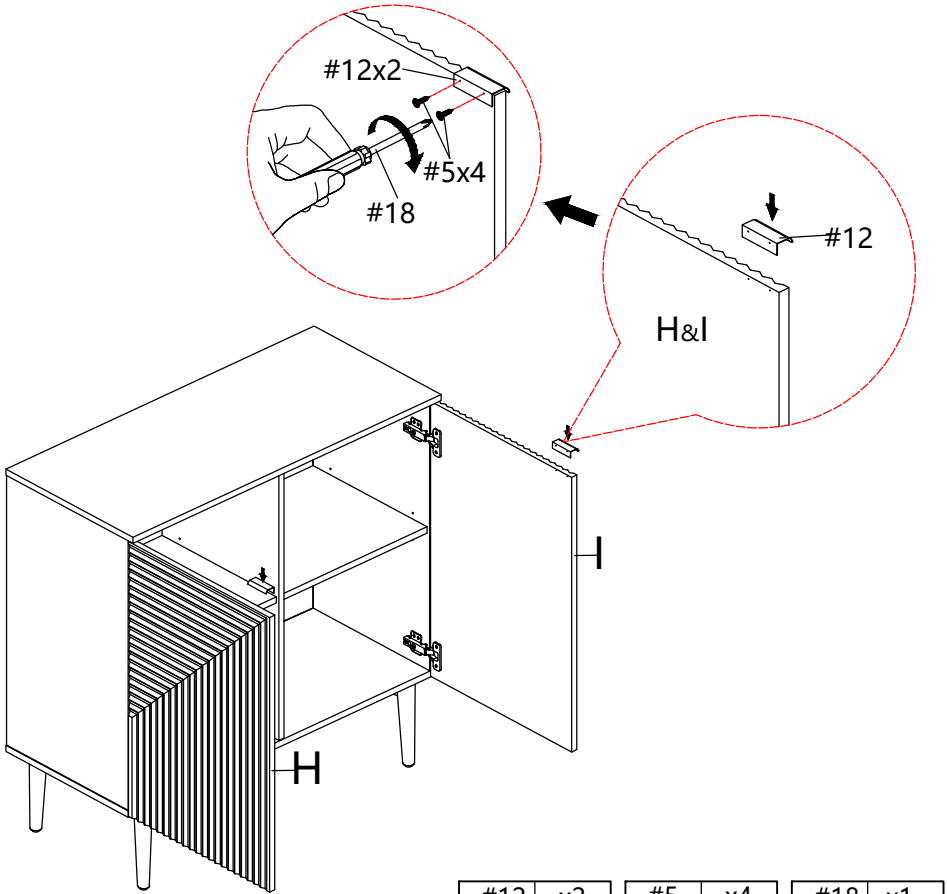

STEP-12:

Insert part #12 into the corresponding position of door (I)&(H),and then use screw #5 to attach part #12 to door (H)&(I),make sure all holes aligned and tighten screw #5 with screwdriver #18.

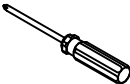

#12	x2	#5	x4	#18	x1
					
		M3.5x14mm			

ASSEMBLY INSTRUCTIONS

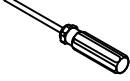

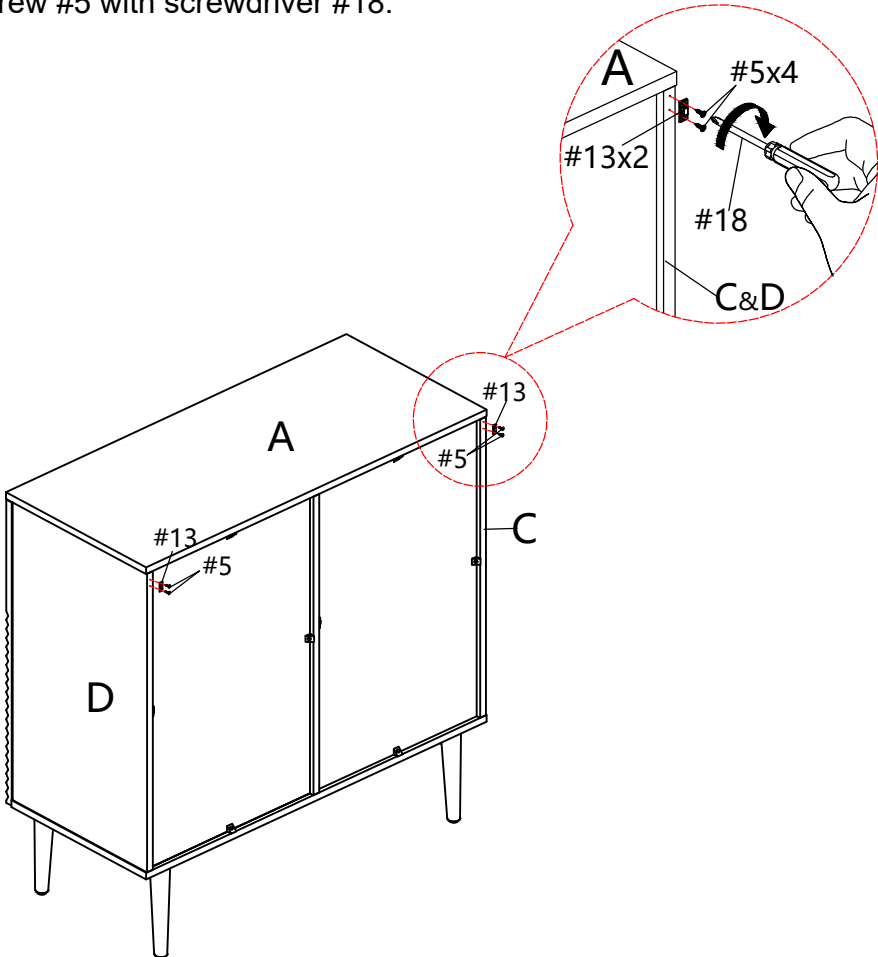

#13	x2	#5	x4	#18	x1
					
		M3.5x14mm			

STEP-13:

Use screw #5 to attach plastic bracket #13 to panel (C)&(D), tighten screw #5 with screwdriver #18.

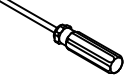

ASSEMBLY INSTRUCTIONS

#13	x2	#6	x4	#18	x1	#14	x4
							
		M4x35mm				∅8x30mm	

STEP-14:

1. Mark the position on the wall, that corresponds to the location of bracket #13 on the side panel (C)&(D); Drill and insert the expandable screw #14 by hammer.
2. Assemble the bracket #13 to the wall. Align the hole in the bracket #13 with the expandable screw #14, use screw #6 to attach it, tighten screw #6 with screwdriver #18.

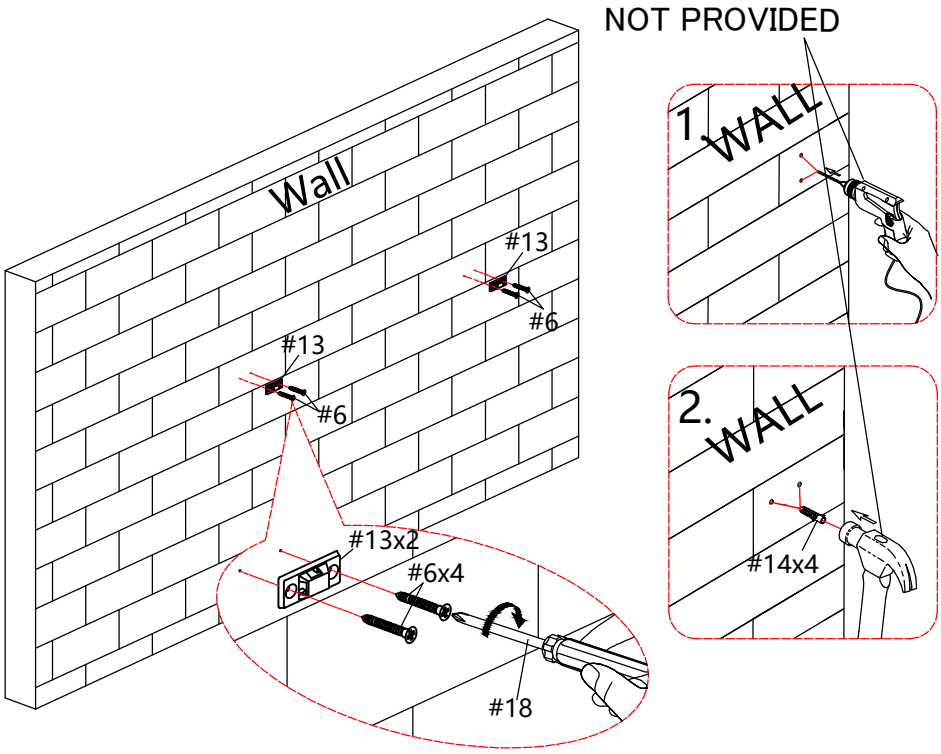

ASSEMBLY INSTRUCTIONS

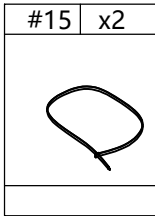

STEP-15

3. Let the plastic belt #15 pass through bracket #13 and pull tightly.

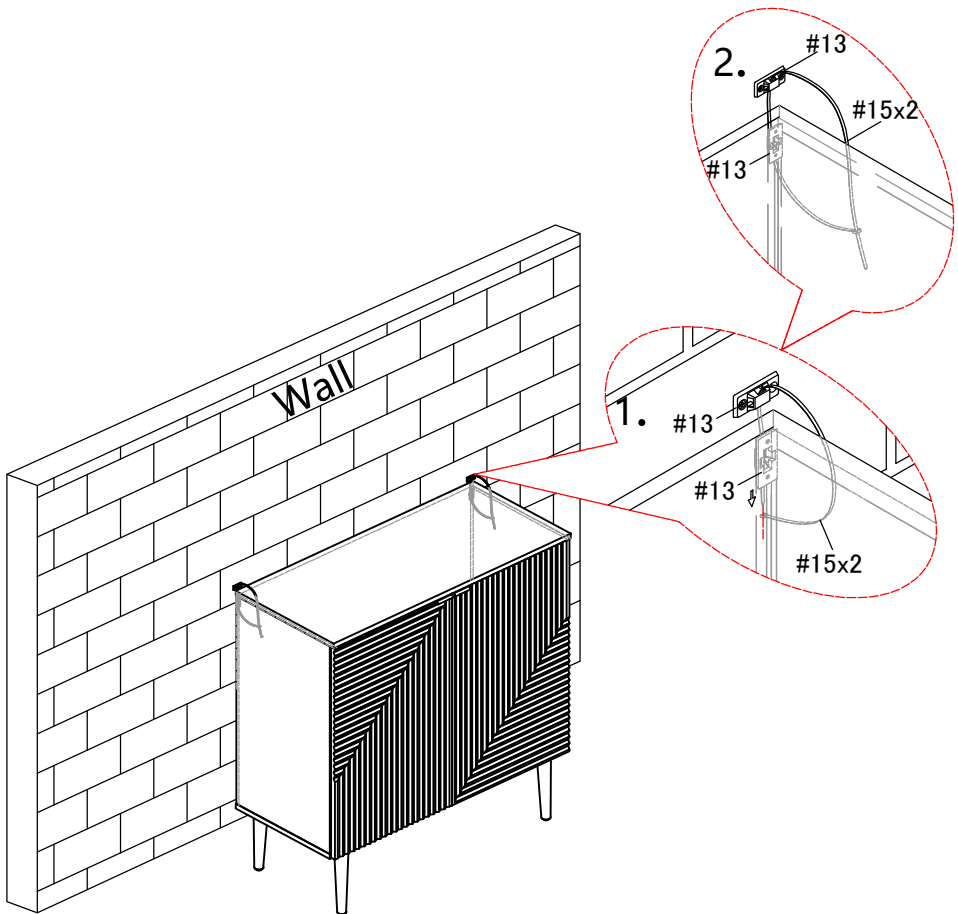

WARRANTY

1. We strive to offer high-quality products, and we also try our best to satisfy each and every customer that orders from us with product or service as needed.
2. We provide 30 days warranty starting from the time you receive the item. Each customer must provide a record of their order such as the order number, or item receipt for any items that are out of the warranty period you may also still receive.
3. Replacement parts by purchasing them with our company if they are available.