

### USE AND MAINTENANCE

- Use on level surfaces only
- Because this product needs assembly, it is prone to working itself loose from time to time depending on the use. Please take the time to check that all connections are still tight and working properly for safety.
- Only clean using a damp cloth and mild detergent, do not use bleach or abrasive cleaners.

## Chesterfield Chair

### PART LIST

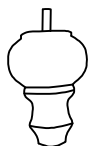
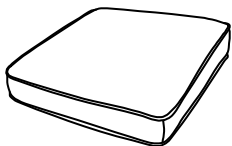
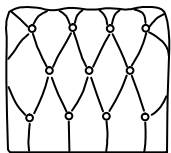
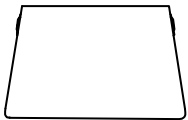
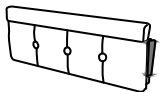
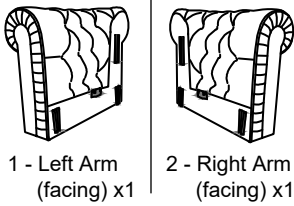

### HARDWARE

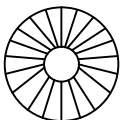

### Assembly Instructions

①

Select 1, 2, 3, 8 x2, A x2.  
Insert post of 8 into A and into hole on under side of 1. Turn 8 clockwise to hand tighten. Repeat 8, A into 2. Align 3 brackets (with tuft fabric facing out) to the brackets in 1 & 2 at the front of 1 & 2. Insert 3 into 1 & 2 until down and tight.

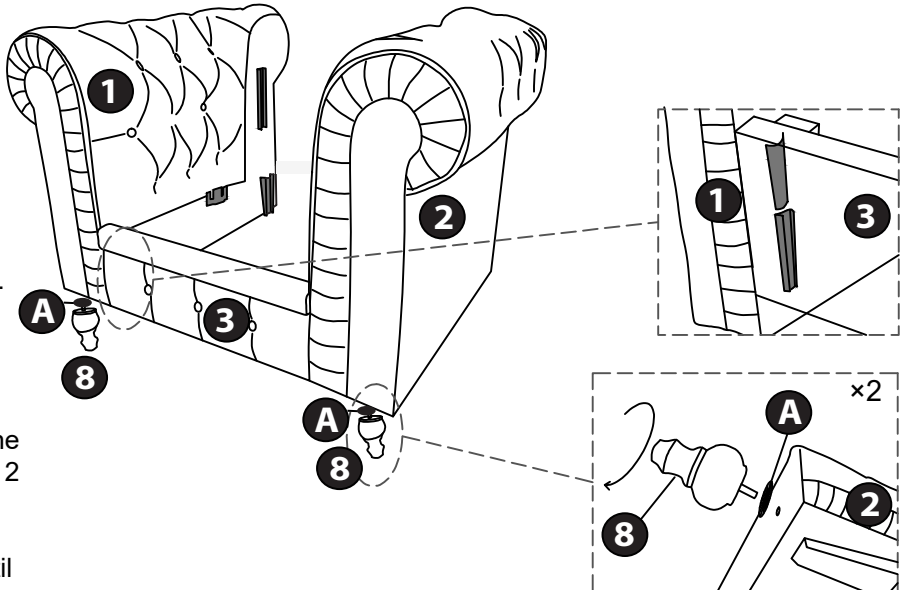

②

Select 4, 8 x2, A x2.  
Insert post of 8 into A and into hole on under side of 1. Turn 8 clockwise to hand tighten. Repeat 8, A into 2. Align 4 brackets to 1 & 2 at the rear of 1 & 2. Insert 4 into 1 & 2 until down and tight.

REVERSE VIEW

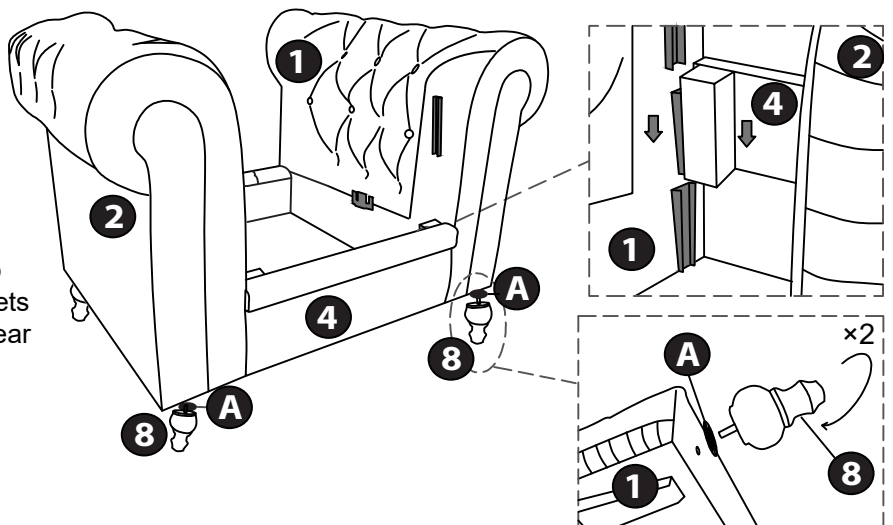

#### USE AND MAINTENANCE

- Use on level surfaces only
- Because this product needs assembly, it is prone to working itself loose from time to time depending on the use. Please take the time to check that all connections are still tight and working properly for safety.
- Only clean using a damp cloth and mild detergent, do not use bleach or abrasive cleaners.

## Chesterfield Chair

### PART LIST



5 - Seat Support x1

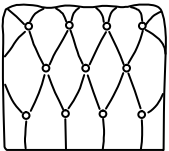

6 - Backrest x1

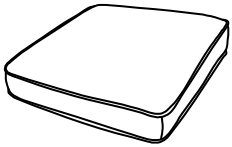

7 - Seat Cushion x1

### Assembly Instructions

**3**

Select 5, 6.  
Align brackets on 5, 1 & 2.  
Insert bracket on 5 into bracket on 1 until it clicks.  
Repeat for 5 into bracket on 2.  
Align brackets on 6, 1 & 2.  
Insert bracket on 6 into 1 & 2 until stops. Lightly lift back to ensure tight.

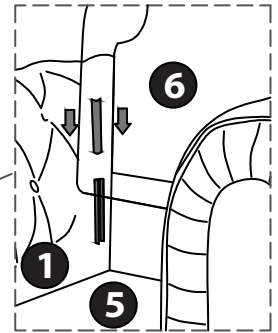
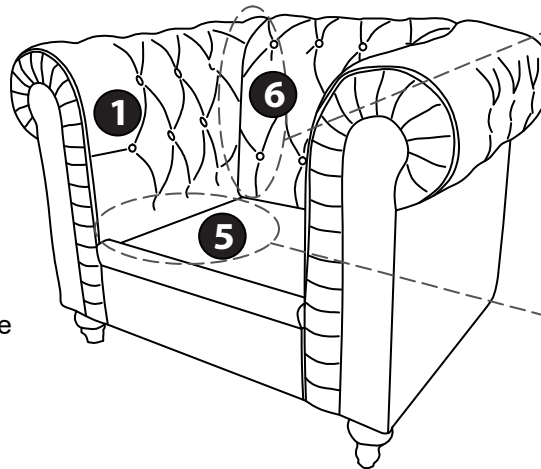

SEE THROUGH VIEW

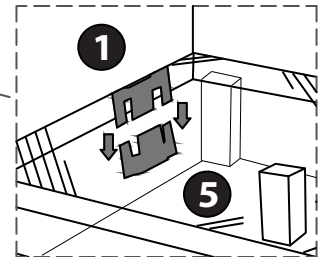

**4**

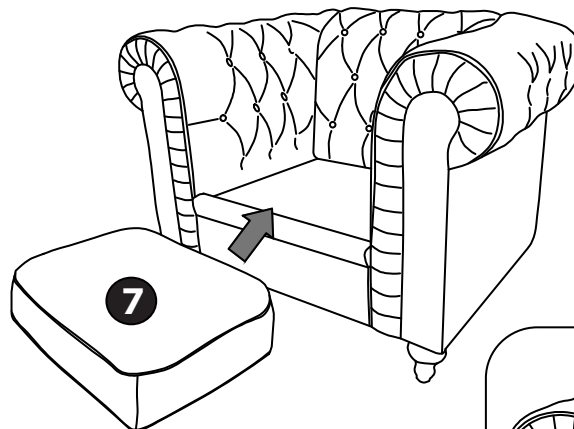

Select 7. Insert 7 into chair assembly.

