

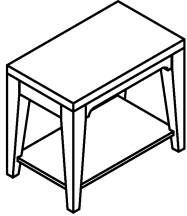

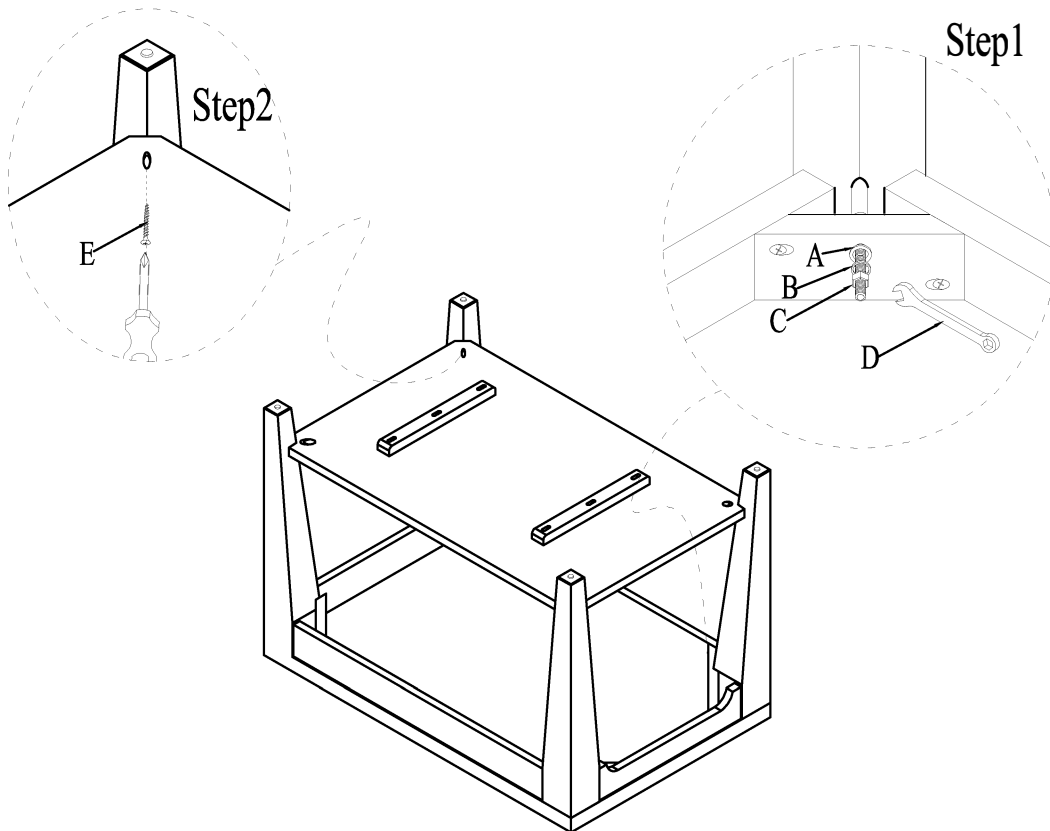



## ASSEMBLY INSTRUCTION



### IMPORTANT NOTES :

- . Place all wooden parts on a clean and smooth surface such as a rug or carpet to prevent the parts from being scratched.
- . Check to be sure that you have all parts and hardware.
- . Remove all wrapping materials, including staples and packing straps before you start to assemble.
- . Do not tighten all screws and bolts until completely assembled.
- . Keep all hardware out of the reach of children.



NO.	PART DESCRIPTION		QTY
A	Flat washer 5/16**19		8pcs
B	Lock washer 5/16"		8pcs
C	Nut 5/16"		8pcs
D	Wrench (12mm)		1pcs
E	SCREW (8*32mm)		4