

▲ AVERTISSEMENT	▲ WARNING	
<p>Des enfants sont morts à cause du renversement de meubles. Pour réduire le risque de renversement des meubles:</p> <ul style="list-style-type: none"> • Installez TOUJOURS le dispositif anti- basculement fourni. • NE JAMAIS placer un téléviseur sur ce produit. • NE JAMAIS laisser un enfant se tenir debout sur les tiroirs, les portes ou les tablettes, y grimper ou s'y suspendre. • N'ouvrez JAMAIS ouvrir plus d'un tiroir à la fois. • Mettre les objets les plus lourds dans les tiroirs du bas. <p><i>Cette étiquette est permanent Ne pas la retirer !</i></p>	<p>Children have died from furniture tipover. To reduce the risk of furniture tipover:</p> <ul style="list-style-type: none"> • ALWAYS install anti-tip device provided. • NEVER put a TV on this product. • NEVER allow children to stand, climb, or hang on any drawers, doors or shelves. • NEVER open more than one drawer at a time. • Place heaviest items in the lowest drawers. <p><i>This is a permanent label. Do not remove !</i></p>	

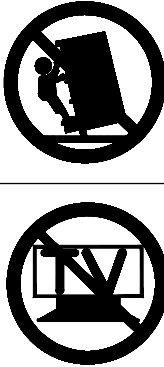
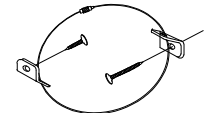
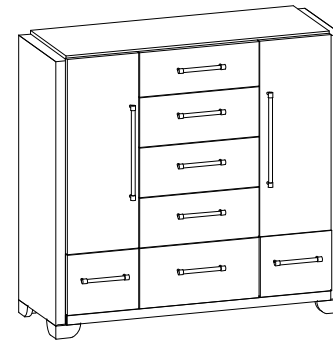
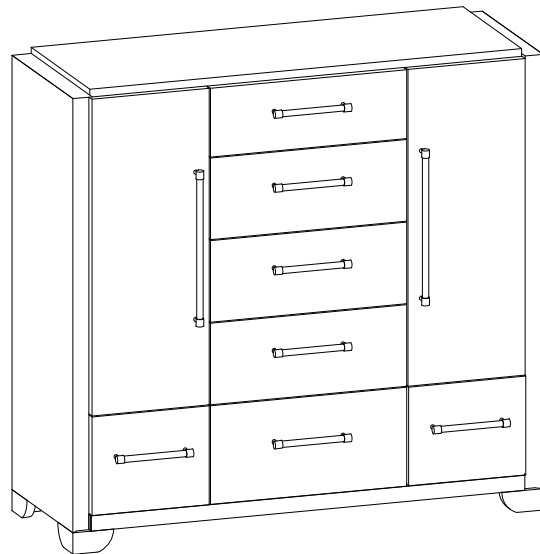

Ⓐ

x1 Door Chest
x1 Comode
x1 Cómoda

Ⓑ

x1 Anti-tipping Restraint *
x1 Systeme antibasculement
x1 Control para evitar vulcos

* Replaceable Part

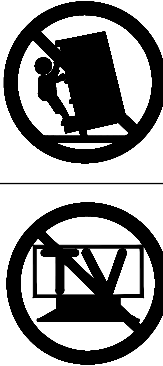
▲ AVERTISSEMENT	▲ WARNING	
<p>Des enfants sont morts à cause du renversement de meubles. Pour réduire le risque de renversement des meubles:</p> <ul style="list-style-type: none"> • Installez TOUJOURS le dispositif anti- basculement fourni. • NE JAMAIS placer un téléviseur sur ce produit. • NE JAMAIS laisser un enfant se tenir debout sur les tiroirs, les portes ou les tablettes, y grimper ou s'y suspendre. • N'ouvrez JAMAIS ouvrir plus d'un tiroir à la fois. • Mettre les objets les plus lourds dans les tiroirs du bas. <p><i>Cette étiquette est permanente Ne pas la retirer !</i></p>	<p>Children have died from furniture tipover. To reduce the risk of furniture tipover:</p> <ul style="list-style-type: none"> • ALWAYS install anti-tip device provided. • NEVER put a TV on this product. • NEVER allow children to stand, climb, or hang on any drawers, doors or shelves. • NEVER open more than one drawer at a time. • Place heaviest items in the lowest drawers. <p><i>This is a permanent label. Do not remove !</i></p>	

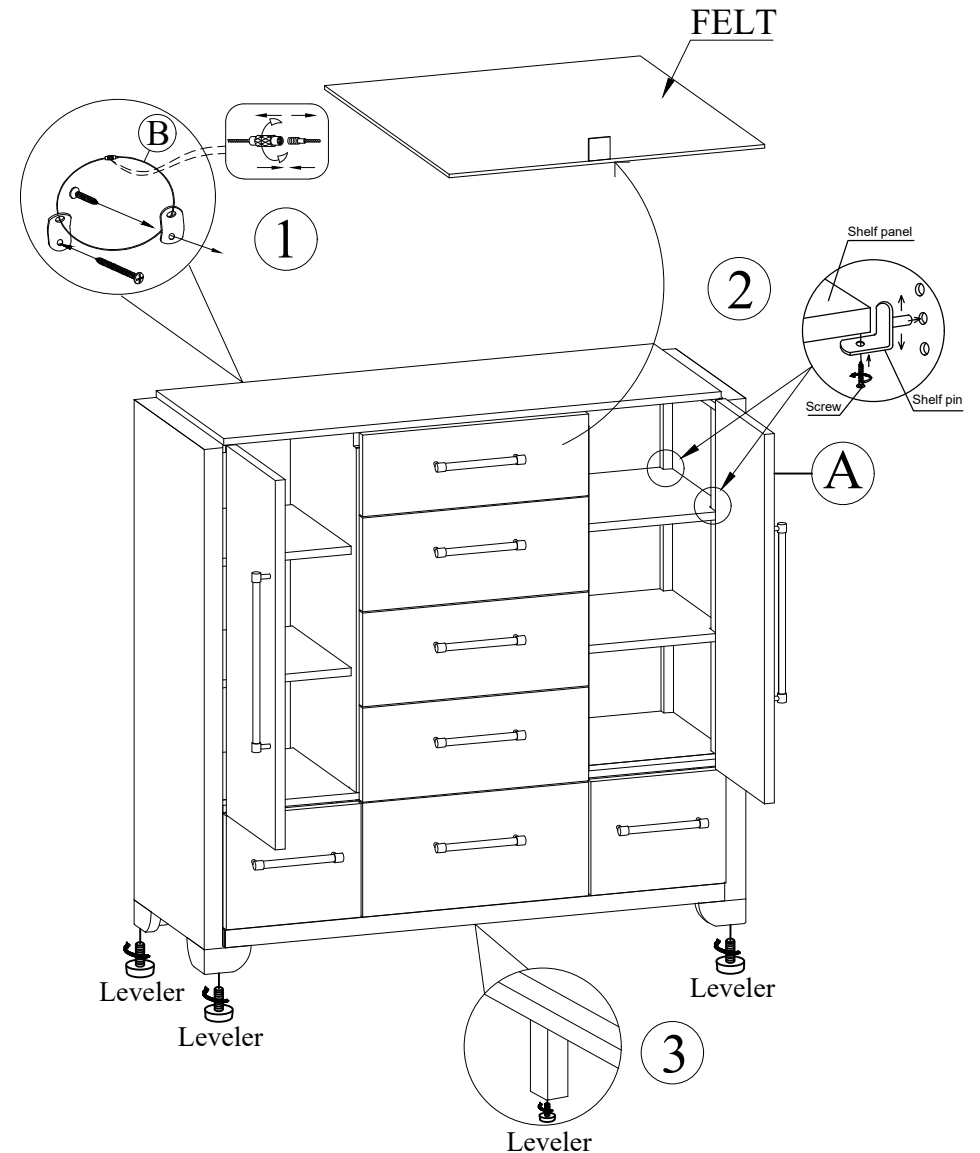
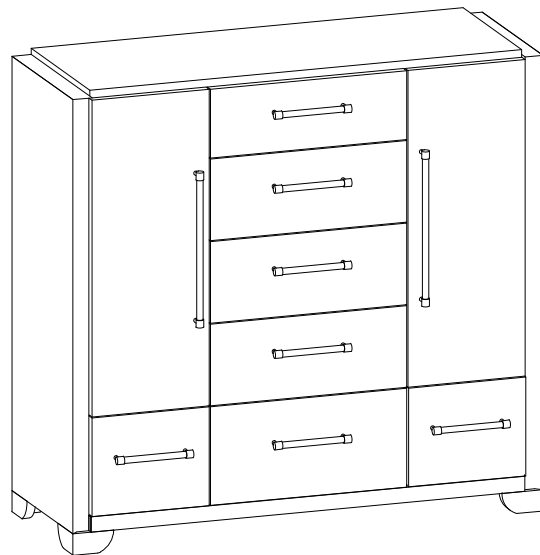

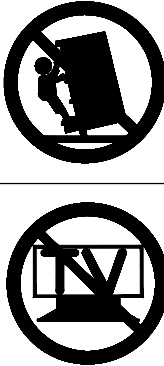
▲ AVERTISSEMENT	▲ WARNING	
<p>Des enfants sont morts à cause du renversement de meubles. Pour réduire le risque de renversement des meubles:</p> <ul style="list-style-type: none"> • Installez TOUJOURS le dispositif anti-basculement fourni. • NE JAMAIS placer un téléviseur sur ce produit. • NE JAMAIS laisser un enfant se tenir debout sur les tiroirs, les portes ou les tablettes, y grimper ou s'y suspendre. • N'ouvrez JAMAIS ouvrir plus d'un tiroir à la fois. • Mettre les objets les plus lourds dans les tiroirs du bas. <p><i>Cette étiquette est permanent Ne pas la retirer !</i></p>	<p>Children have died from furniture tipover. To reduce the risk of furniture tipover:</p> <ul style="list-style-type: none"> • ALWAYS install anti-tip device provided. • NEVER put a TV on this product. • NEVER allow children to stand, climb, or hang on any drawers, doors or shelves. • NEVER open more than one drawer at a time. • Place heaviest items in the lowest drawers. <p><i>This is a permanent label. Do not remove !</i></p>	

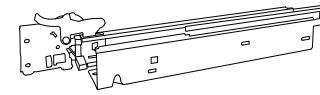

x7 RP402100-GLIDE
Undermount Soft Close *
Fermeture douce sous-montée
Cierre suave con montaje inferior



x2 RCP402-LHANDLE
Long Handle With Screw *
Poignée Longue Avec Vis
Manija Larga Con Tornillo

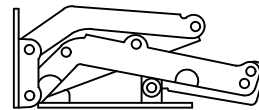
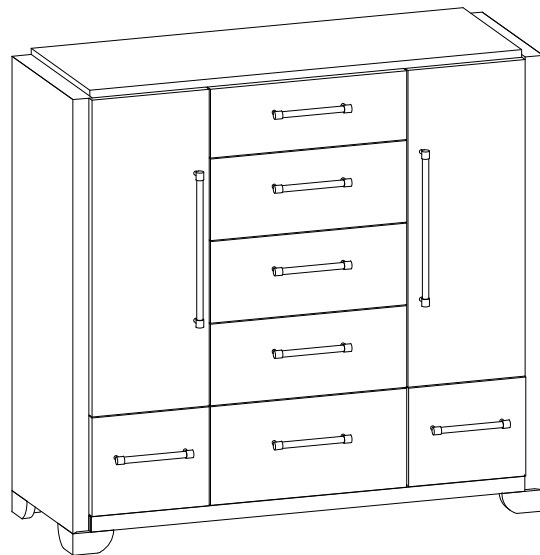

x4 RP402125-HINGES
Side Door Hinge *
Charnière de porte
Bisagra de la puerta



x7 RCP402-SHANDLE
Short Handle With Screw *
Poignée Courte Avec Vis
Manija Corta Con Tornillo

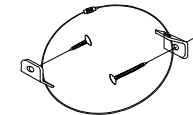

x1 RC-ANTI-TIP-M
Anti-tipping Restraint *
Système antibasculement
Control para evitar vulcos

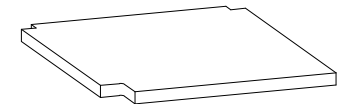

x4 RP402125-SHELF
Wood Shelf *
Étagère En Bois
Estante De Madera

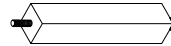

x1 RP402125-CELEG
Center Leg *
Support central
Soporte para la pata central

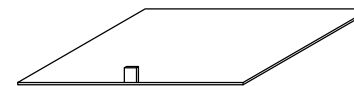

x1 RP402125-FELT
Removable Felt *
Feutre
Fieltro



x4 RC-LEVE-WHILE
White Leveler *
Patin réglable
Nivelador

* Replaceable Part