

(12) **United States Design Patent**
Mao

(54) **DOG CRATE FURNITURE**

S * 6/2018 Rathman D30/114
 S * 11/2018 Davis D6/661
 S * 6/2019 Rathman D30/114
 S * 7/2019 Rathman D30/114
 S * 7/2019 Rathman D30/114
 S * 12/2019 Davis D6/671

(Continued)

(*) Notice: Patent file contains an affidavit/declaration under 37 CFR 1.130(b).

FOREIGN PATENT DOCUMENTS

(**) Term: **15 Years**

* 12/2020
 * 12/2020

(Continued)

(22) Filed: **Mar. 1, 2023**

(51) **LOC (14) Cl.** **30-02**

(52) **U.S. Cl.**
 USPC **D30/108; D30/114**

(58) **Field of Classification Search**
 USPC D30/108–120, 160, 199, 161; D6/657,
 D6/384, 390, 661, 671, 671.1, 675.1
 CPC A01K 31/18; A01K 1/033; A01K 1/0245;
 A01K 1/034; A01K 1/035; A01K 1/0035;
 A01K 1/00; A01K 1/02; A01K 1/03;
 A01K 1/031

(Continued)

Primary Examiner — Andrew T Nemeth
(74) Attorney, Agent, or Firm — Jose Cherson Weissbrot

See application file for complete search history.

(57) **CLAIM**

The ornamental design for a dog crate furniture, as shown and described.

(56) **References Cited**

U.S. PATENT DOCUMENTS

3/1993 Darby D30/108
 2/2008 Weatherly D6/671.1
 12/2008 Warman D30/108
 2/2010 Henley D30/112
 3/2010 Jakubowski
 3/2010 Jakubowski
 8/2010 Jakubowski
 8/2010 Jakubowski
 6/2011 Henley D30/108
 8/2011 Hughey A01K 1/034
 119/500
 1/2012 Jakubowski
 10/2012 Zambelli D6/657
 2/2015 Lee
 1/2018 Everson D6/657

DESCRIPTION

FIG. 1 is a front perspective view of a dog crate furniture, showing my new design;
 FIG. 2 is a rear perspective view thereof;
 FIG. 3 is a front elevational view thereof;
 FIG. 4 is a rear elevational view thereof;
 FIG. 5 is a left side view thereof, the right side view being a mirror image of FIG. 5;
 FIG. 6 is a top plan view thereof; and,
 FIG. 7 is a bottom plan view thereof.
 Broken lines in the drawings depict portions of the dog crate furniture that form no part of the claimed design.

1 Claim, 7 Drawing Sheets

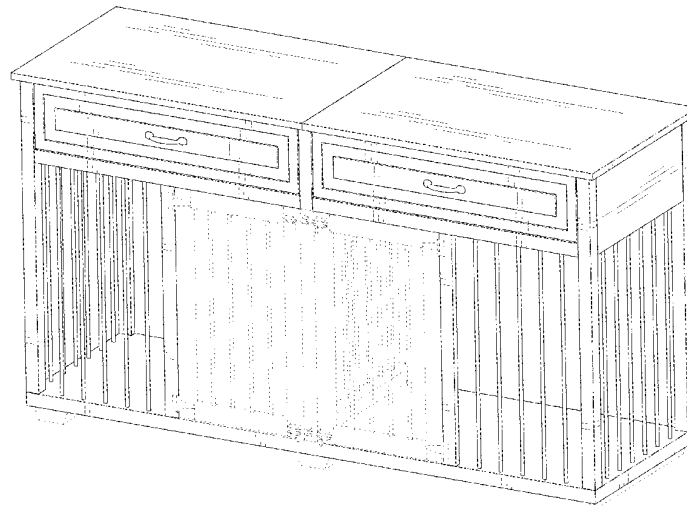

(56)

References Cited

U.S. PATENT DOCUMENTS

12/2020 Xin
1/2021 Noe
1/2022 Packer D6/657
9/2022 Shen D6/675.1
10/2022 Shen D6/657
4/2005 Passno A01K 1/03
119/500
4/2007 Roberts A01K 31/06
119/477
10/2007 Chern A01K 5/0291
119/482
7/2017 Rathman A01K 1/0245
6/2019 Xin A01K 1/033

FOREIGN PATENT DOCUMENTS

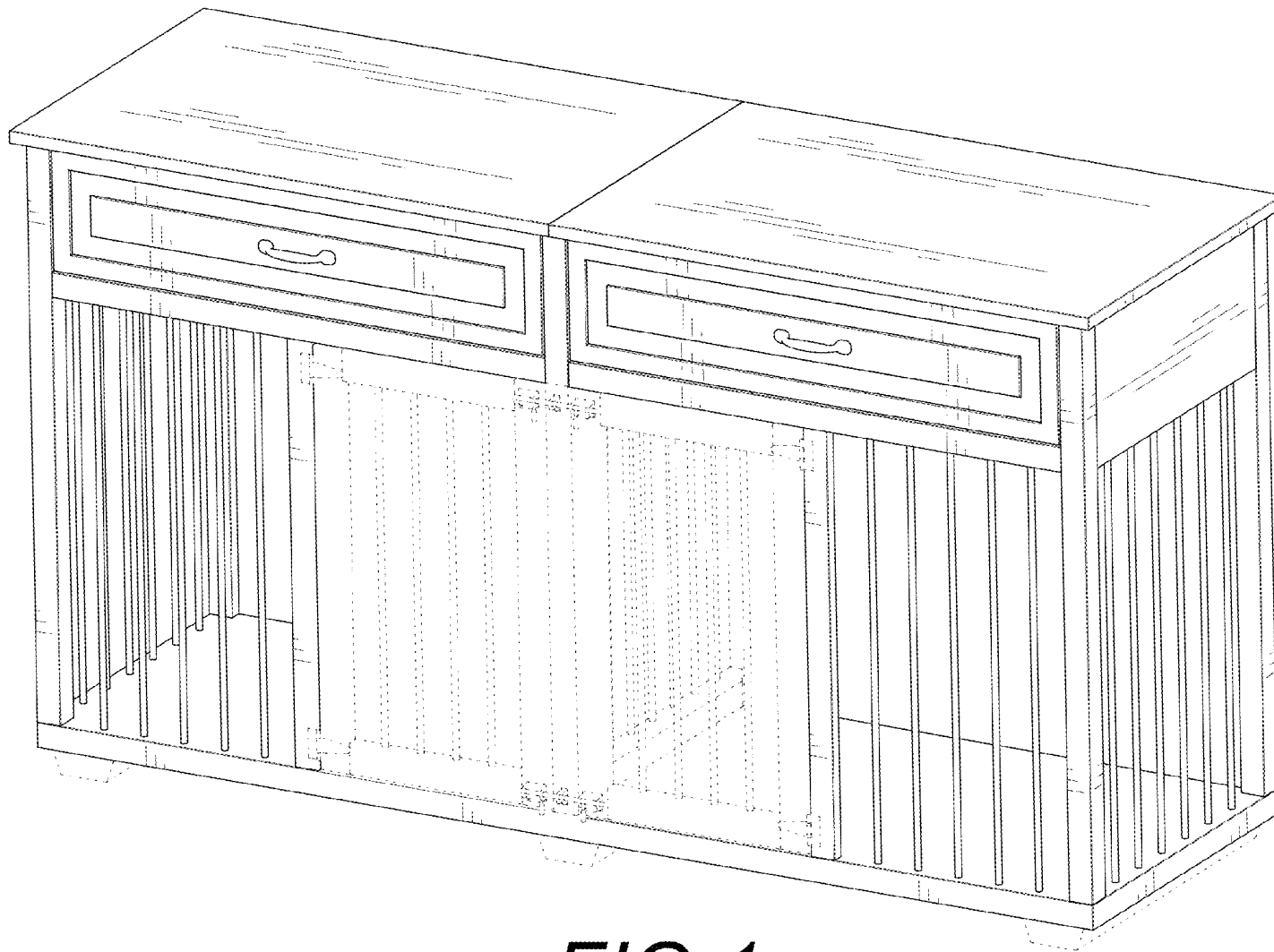

FIG. 1

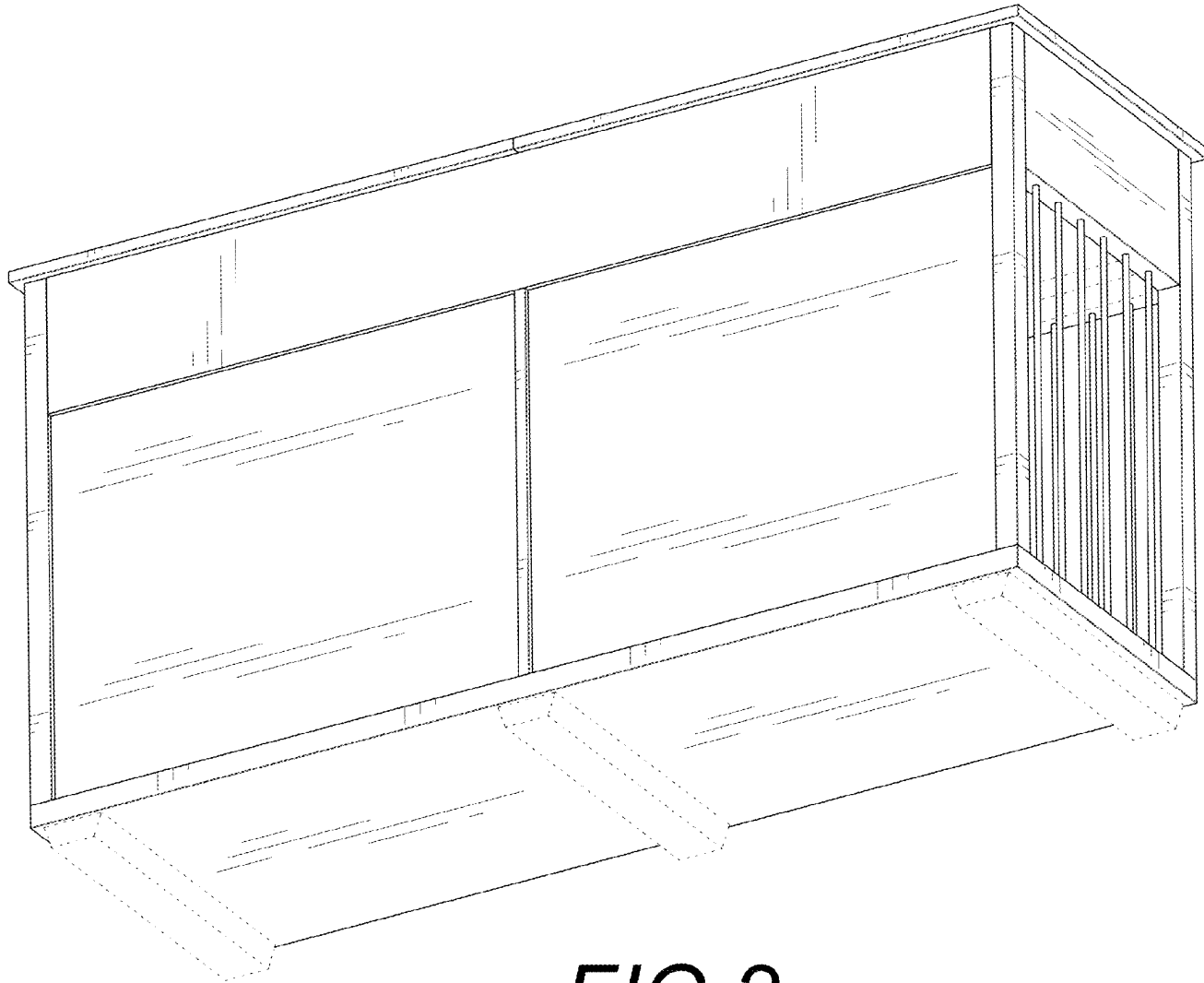

FIG. 2

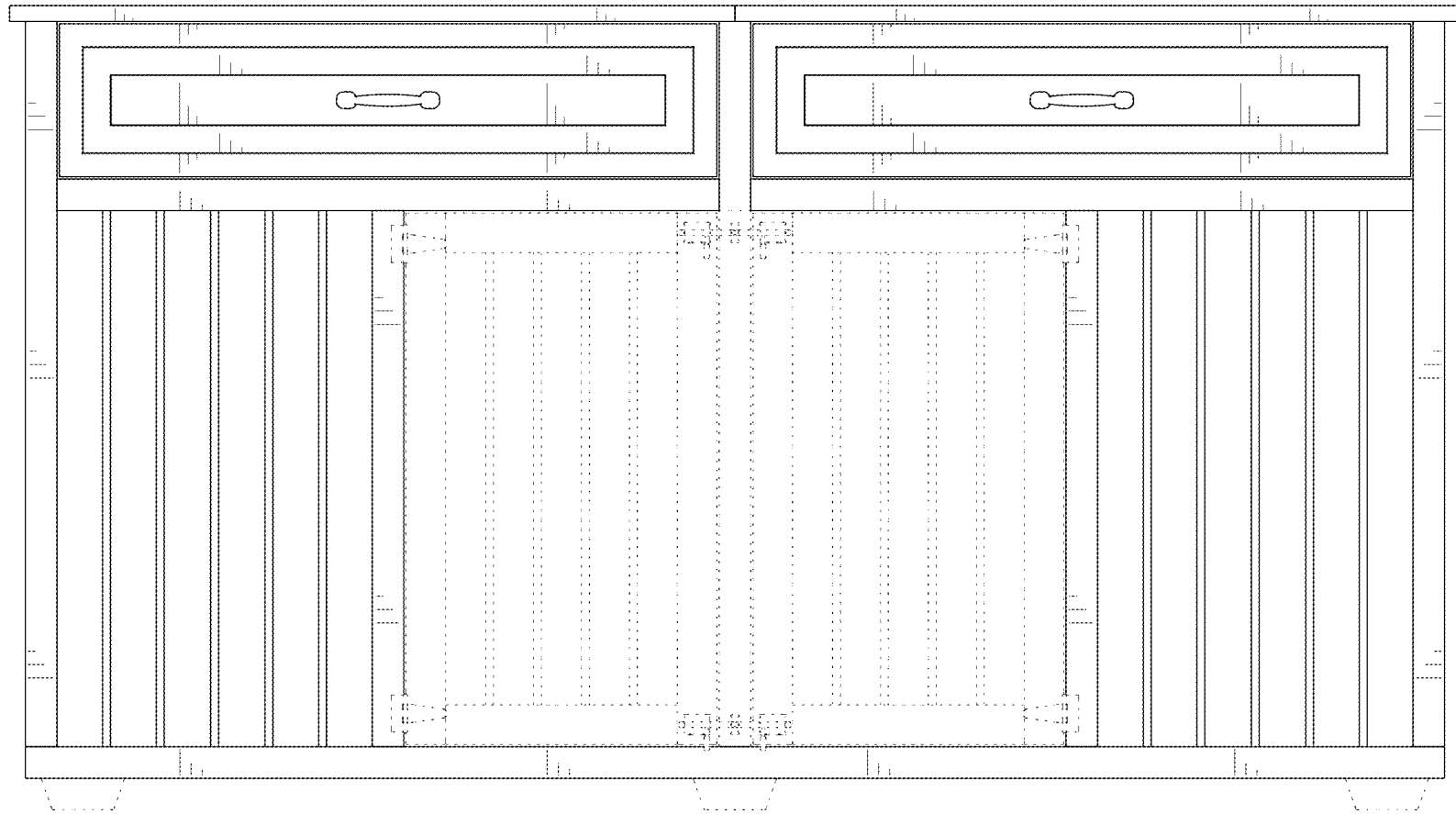

FIG.3

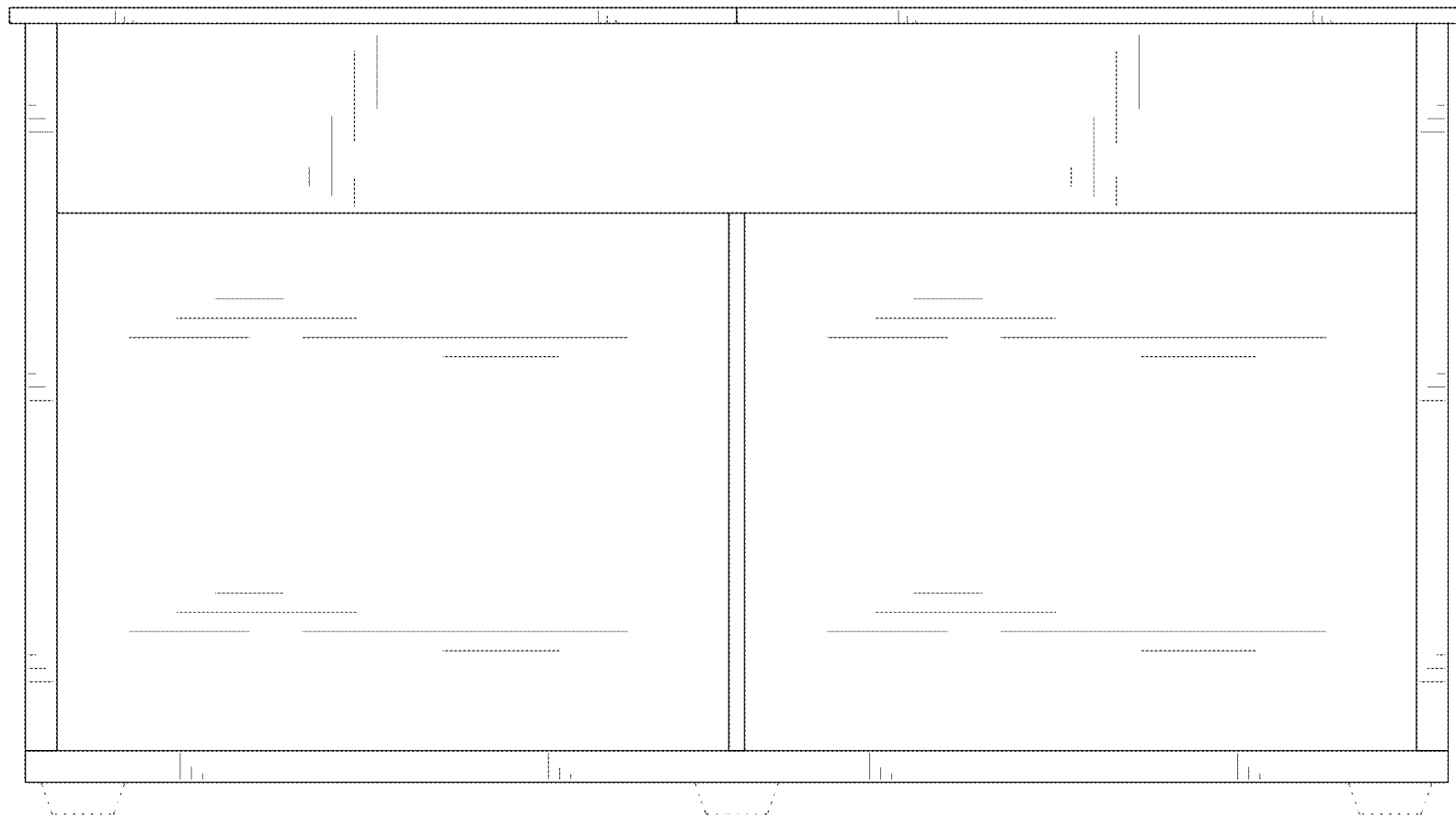

FIG.4

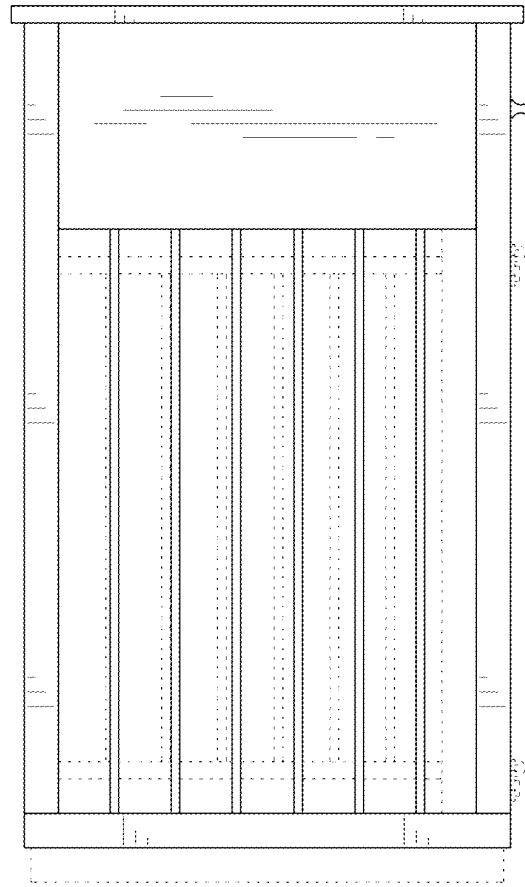

FIG.5

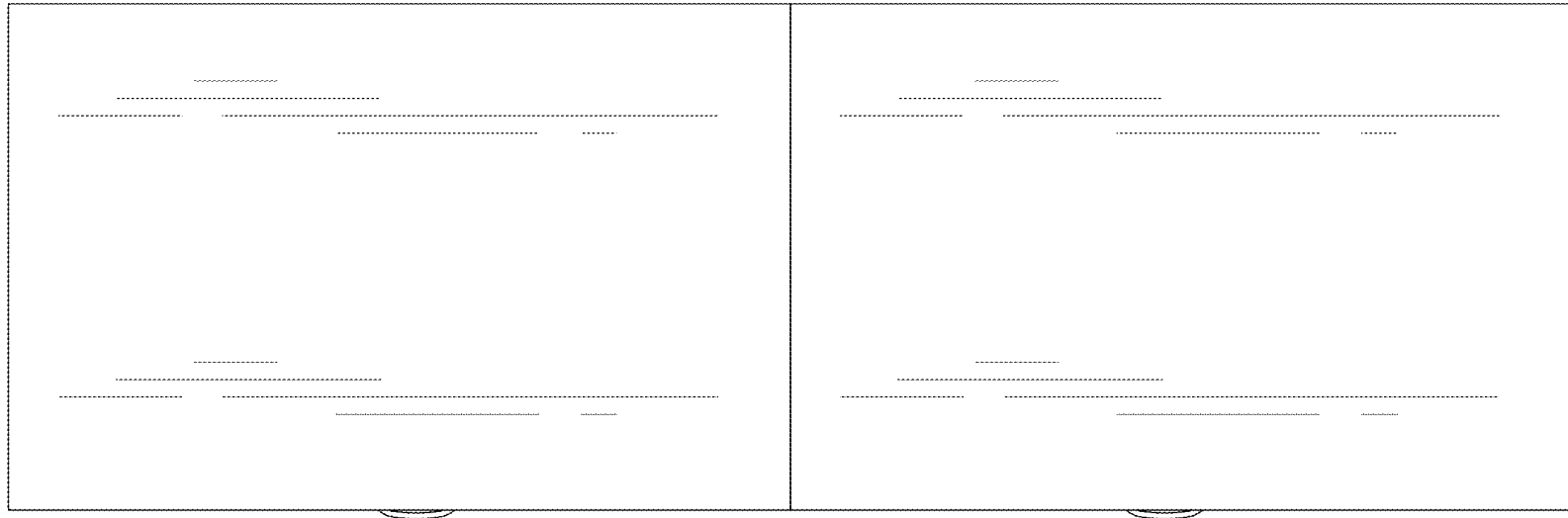

FIG.6

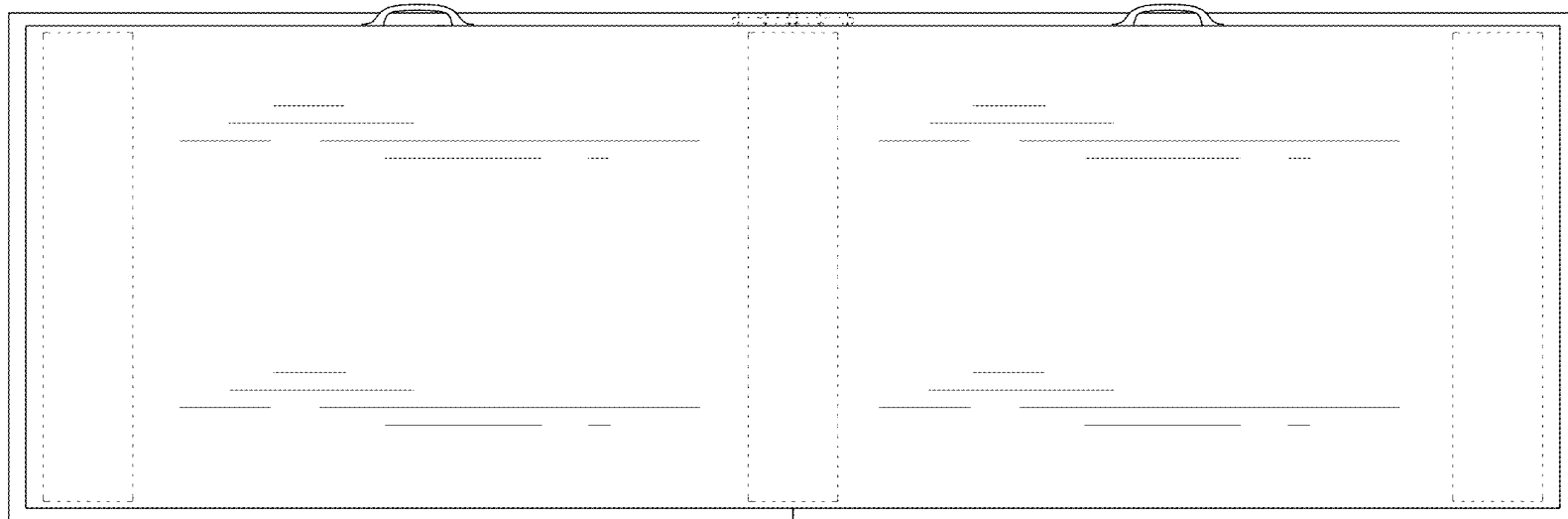

FIG.7