

# ASSEMBLY INSTRUCTIONS

## COVE WOOD BACK CHAIR











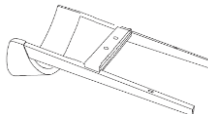

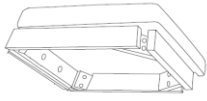
**Please read instructions carefully**

Remove all wrapping materials, staples and packing straps from the carton. Refer to Parts List and Hardware List and ensure they are complete before you start assembling. Place all wooden parts on a clean, flat and soft surface (e.g carpet or rug) to prevent parts from being scratched.

CAUTIONS: 1) DO NOT FULLY TIGHTEN BOLTS AND NUTS UNTIL ALL PARTS HAVE BEEN ASSEMBLED.

2) DO NOT OVER-TIGHTEN BOLTS AND NUTS .

3) KEEP ALL HARDWARE PARTS OUT OF REACH OF CHILDREN.

Carton	Part	Designation	Part List	QTY	HARDWARE	Hardware List
1	P1	BACK REST		P1 x 2pc	H1	 H1 x 4pc
	P2	CHAIR SEAT		P2 x 2pc		M6x35mm JCBC SCREW
	P3	LEFT STRETCHER L		P3 x 2pc	H2	 H2 x 16pc
	P4	RIGHT STRETCHER R		P4 x 2pc		M6x70mm JCBC SCREW
	P5	FRONT LEG LEFT L		P5 x 2pc	H3	 H3 x 20pc
	P6	FRONT LEG RIGHT R		P6 x 2pc		SPRING WASHER
					H4	 H4 x 20pc Flat Washer
				H5	 H5 x 8pc M4x38mm CSK SCREW	
				H6	 H6 x 1pc Allen Key	

**COMPLETE ASSEMBLY**

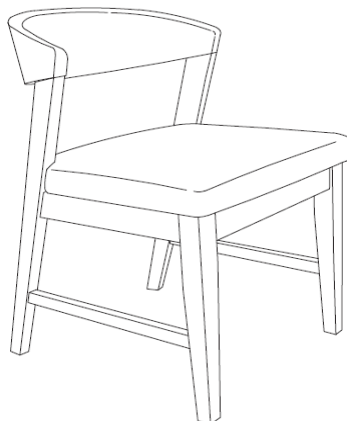



# ASSEMBLY INSTRUCTIONS

## COVE WOOD BACK CHAIR

### STEP 1

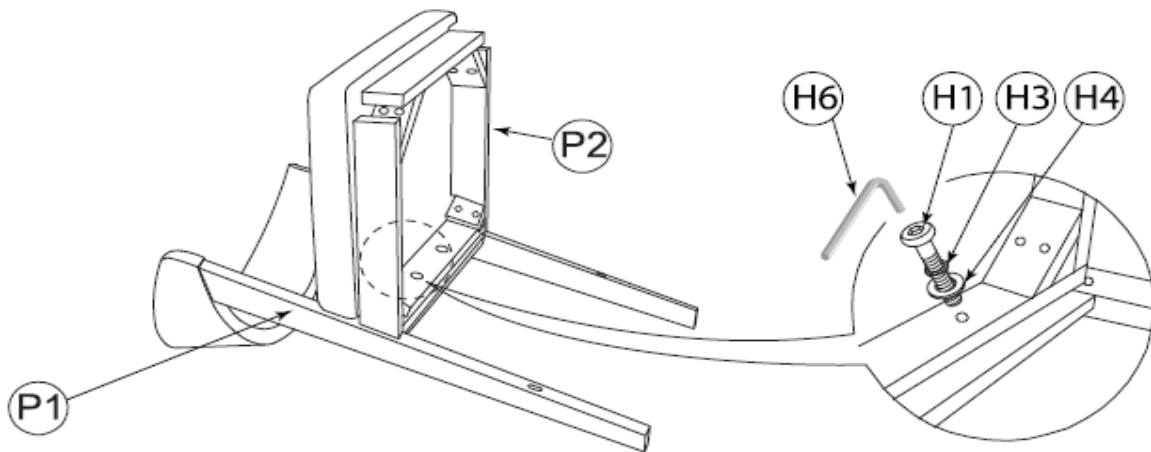

Assembly Chair Seat (P2) into the Back Rest (P1) by aligning Bolts(H1) fitted with Spring Washer (H3) & Flat Washer (H4) into both center pre-drilled holes . Use Allen Key (H6) to tighten the bolts.

H1 x 2	 M6 x 35mm
H3 x 2	
H4 x 2	



### STEP 2

Now, proceed to secure the inside corners by aligning two set of bolts, on each side of the chair seat to finish securing it to the Back Rest. See image below for corresponding hardware to use.

H2 x 4	 M6 x 70mm
H3 x 4	
H4 x 4	

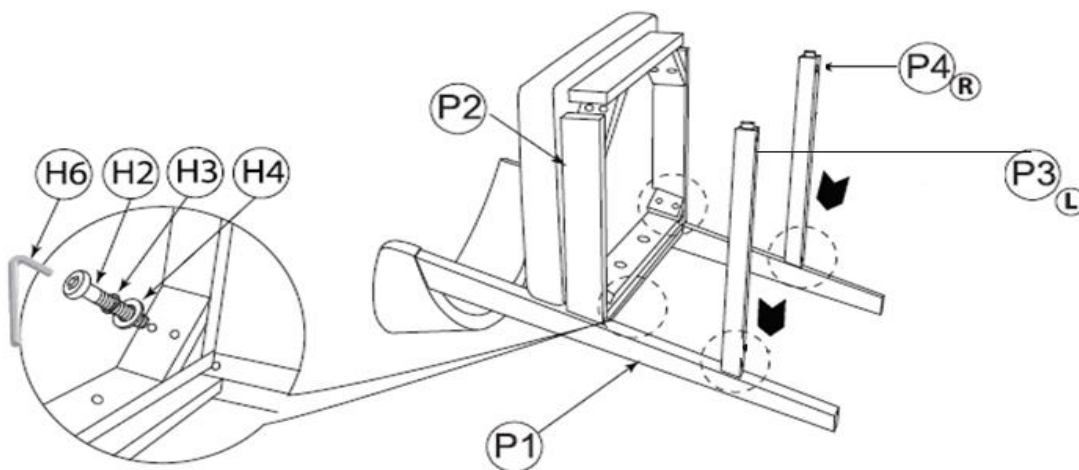



Insert Left Stretcher (P3) and Right Stretcher (P4) into the designated hole on Back Leg Frame (P1)

# ASSEMBLY INSTRUCTIONS

## COVE WOOD BACK CHAIR

### STEP 3

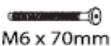
You should now install Right and Left Front Legs (P5 and P6) . Insert legs into designated holes to connect to each side stretcher previously installed. Then, secure each leg to the chair seat frame by aligning corresponding bolts on each sides see image below. Lightly tighten the bolts using Allen Key (H6) just to keep them in place .

H2 x 4	
H3 x 4	
H4 x 4	

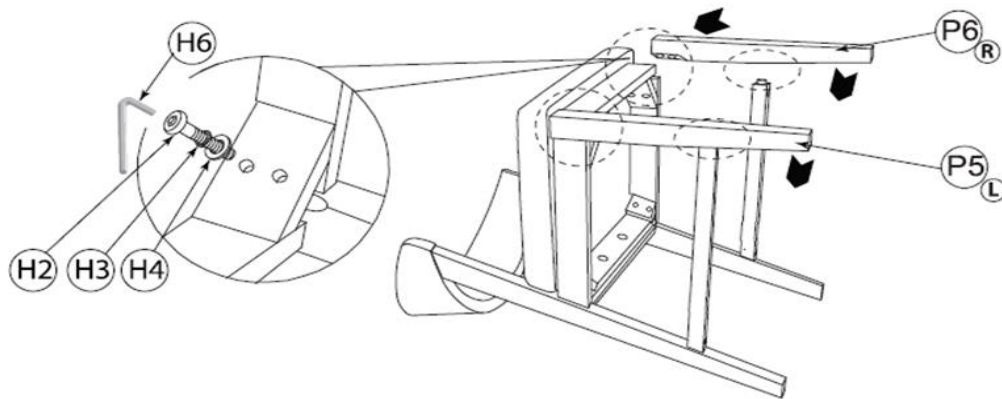

**DO NOT FULLY TIGHTEN BOLTS AT THIS POINT AS ONE LAST STEP IS STILL PENIDNG**

### STEP 4

Align Screw (H5) to fit all the stretchers . Tighten the screws by using a household screwdriver.

H5 x 4	
M4 x 38mm	

**You can now tighten and secure all previously installed bolts to finish securing all parts!!**

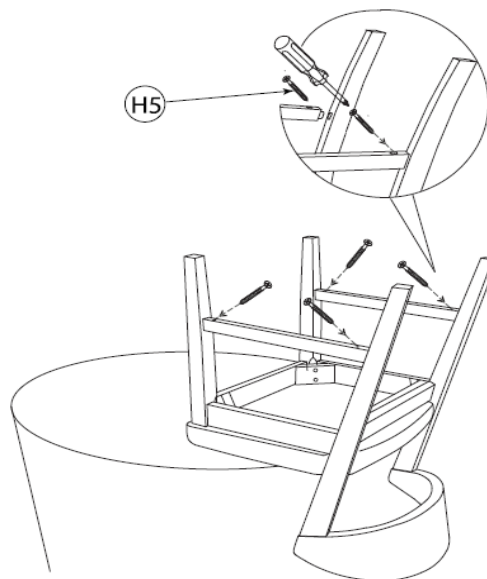

### CARE AND MAINTENANCE

- SAFETY** - To avoid any risk of suffocation to children or animals, dispose off the plastic bags immediately.
- CLEANING** - Clean with damp cloth and mild detergent. Do not use bleach or abrasive products.
- FITTINGS** - Tighten bolts and nuts from time to time to ensure all parts of product are securely fitted.