

DREAMS

IDEA

Instruction Manual



ABOUT US

DREAMSIDEA IS A ONE-STOP HOME
FURNISHING AND SERVICE COMPANY BASED IN USA.
WE ARE DEDICATED TO BRING YOUR DREAM HOME TO LIFE.
OUR SERVICES COVER FROM DESIGN, PRODUCTION,
DIRECT SELL, STORAGE, AND TRANSPORTATION.

IF REALITY IS THE NEAR SHORE
AND IDEALISM THE FAR SHORE,

DREAMSIDEA
AS THE FERRY BETWEEN THEM,
EAGER TO ACCOMPANY YOU ON A JOURNEY
TO YOUR IDEAL HOME.



ITEM NO.S-CS0003 ARMLESS

WARRANTY

We strive to offer high quality product and we also try our best to satisfy each customer that order from us, no matter on products or services as needed. Each customer receives a record of their order, such as the order number or item receipt. For any items that are out of warranty period, you may still be able to purchase the replacement parts from our company if they are available.

Are you having difficulty
with assembly? Missing parts?

Please contact us : info@firstopintl.com

Tel:(562)-781-3327

send an email with your order No. to us

For return, please check the return policy with
the retailer or platforms you bought from.

Appreciate your purchasing from us.

Pop up your life by our furniture !

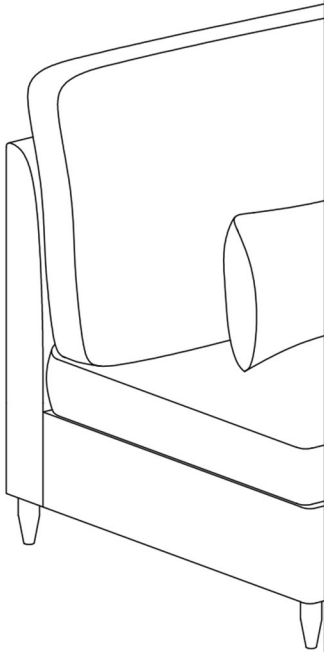

MAINTENANCE AND WARNING

Please read the manual thoroughly
before you start installing.

Please keep the product away from
sharp object.

Packaging and small parts may have
chocking hazard, please keep them away
from children and pets.

Please clean the product according to each
clean code, check the product description
for more information.

Please keep the product away from
fire.

If you have any other questions, please
contact us, we will be glad to help you out.

If the product is placed under direct
sunlight, the pattern or color might fade
away overtime.

Check the product periodically to make
sure everything is secured and tightened.

Always use proper tools for installation.

Do not jump on the product.

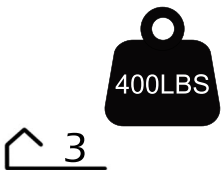

Around 25 min

PRDOUCT DESCRIPTION

Elegant outlook, presenting a high class feeling in your living room

Corduroy fabric along with soft foam sponge, become high resilience cushions that offer you high quality relaxation

Firmly support solid wood legs and metal structure, giving support while long lasting

Highly customizable, simply connect them with everything we provided, and put them anywhere, anyway you want.

Easy assembly, come with all the tools you need, enjoy the sofa in a moment

Dream



House

EXPLODED VIEW

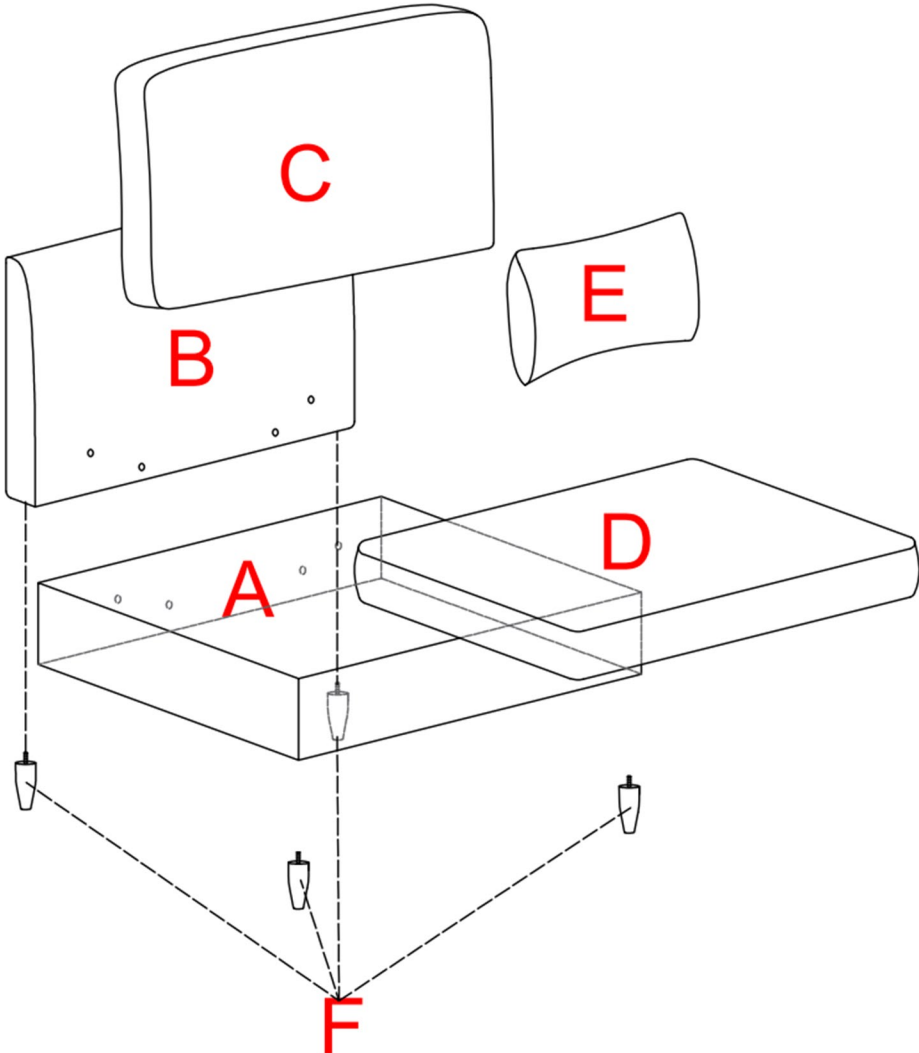

PARTS

A*1

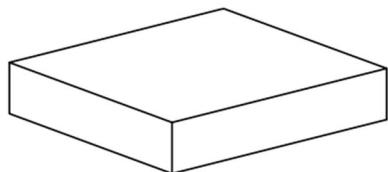

SOFA FRAME

B*1

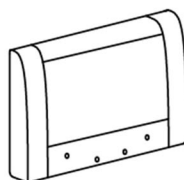

BACK FRAME

C*1

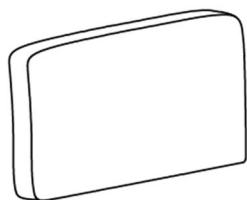

BACK CUSHION

D*1

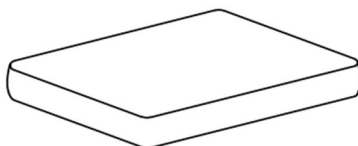

SEAT CUSHION

E*1

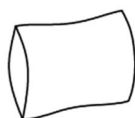

PILLOW

HARDWARE

TOOL LIST

NOTE: Designated with (★) We provide additional spare parts in the hardware package

F*4



Legs

G*1



Metal buckle

H*4

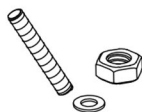

★ Screw&shim&Hex nuts
One of them is a backup

I*1

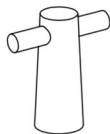

Heagon socket
wrench

Please make sure all hardware&packing material fitting the list.
Especially some small accessories may be missing during
transportation. Please contact us if you have any question.

step 1 ---Cut the plastic air compression bags

After taking out the cushions (C&D) from the air compression bags, please allow them to recover for a period of time. It may take up to 48 hours to fully recover. You can gently slap on them to speed up the process.

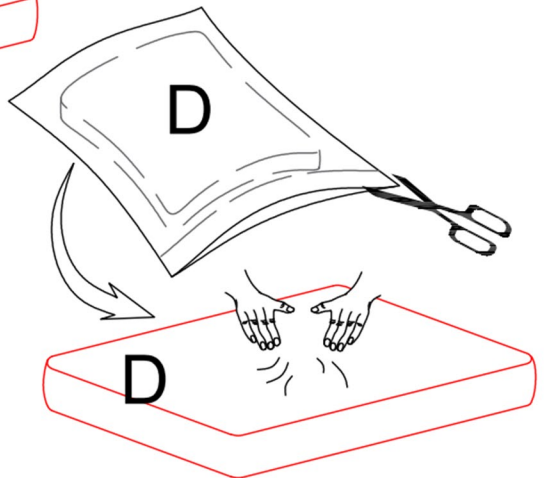
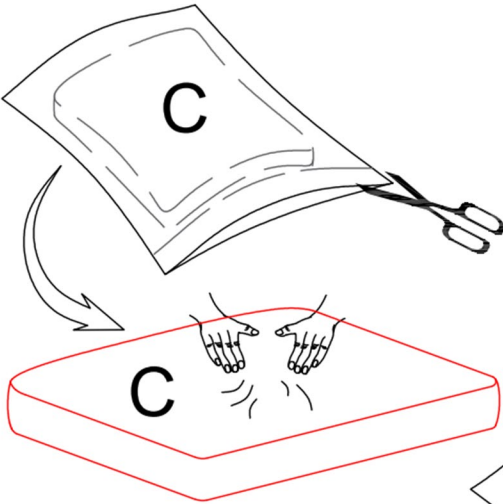
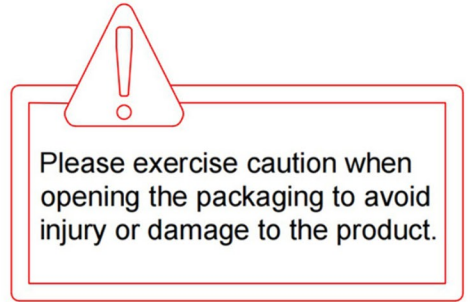

step 2 ---Install the Legs (F)

Screw the legs (F) into each hole on seat frame (A) and back frame (B) as shown, make sure they are tightened.

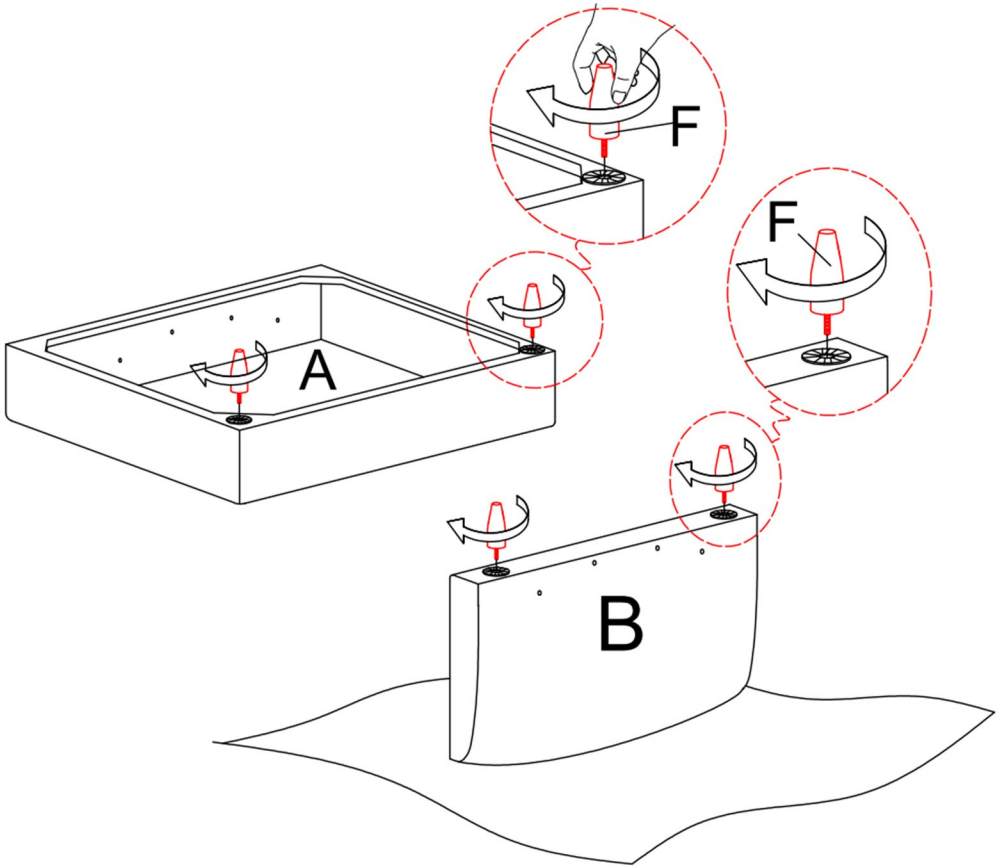

step 3 ---Install the Screws (H)

Align the screws into the pre-drilled holes on the backrest (B), then use hand to twist the screws (H) for 1/3 of their length as shown.

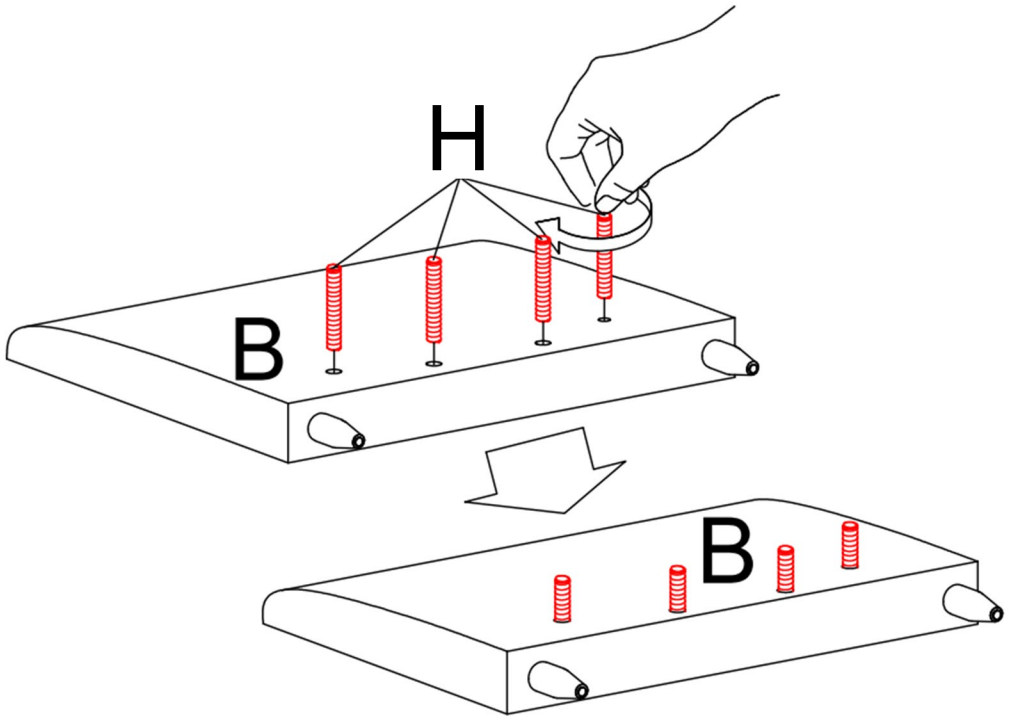

step 4 ---Install the seat frame (A)

First, align the designated holes on the seat frame (A) with the screws on the backrest (B) from the last step as shown. Then place one shim and one hex nut (H) onto each screw (H), use the hexagon socket wrench (I) provided to tighten both nuts.

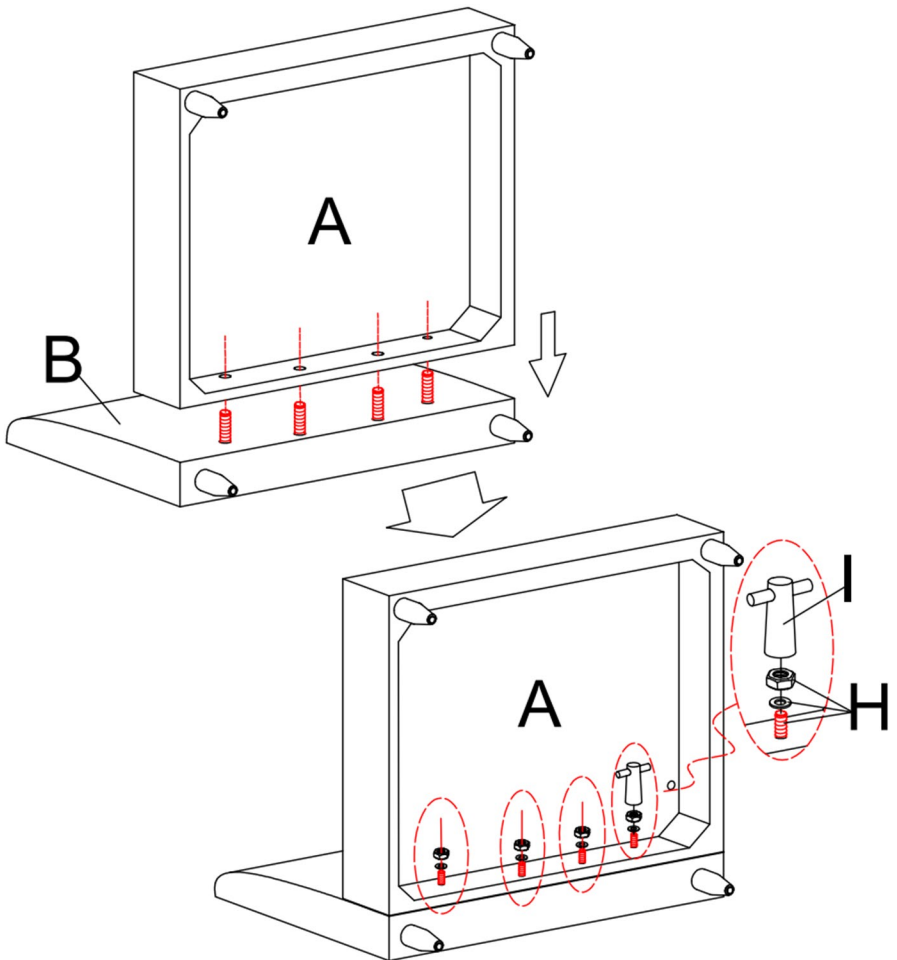

step 5 ---Place the seat cushion (D) &back cushion (C)

Place the seat cushion (D) on to the sofa.

Place the back cushion (C) on to the sofa.

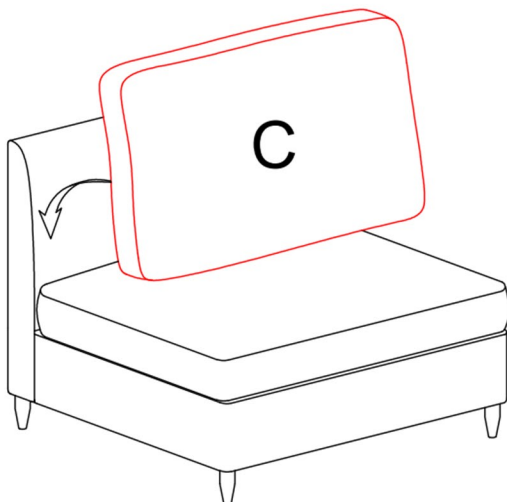
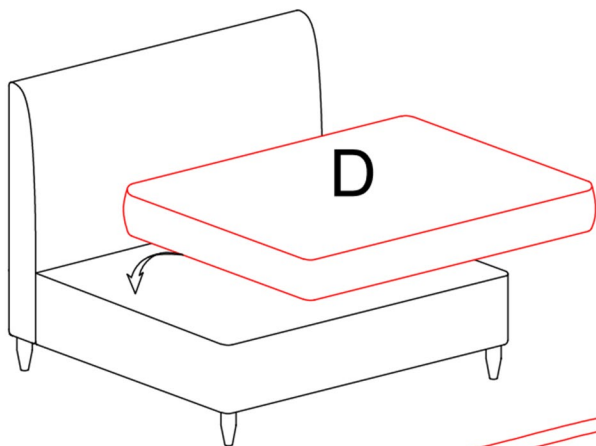
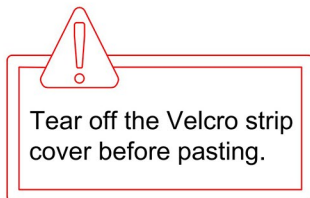
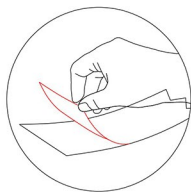

step 6 ---Place the pillow(E)

Place the pillow (E) on to the sofa.

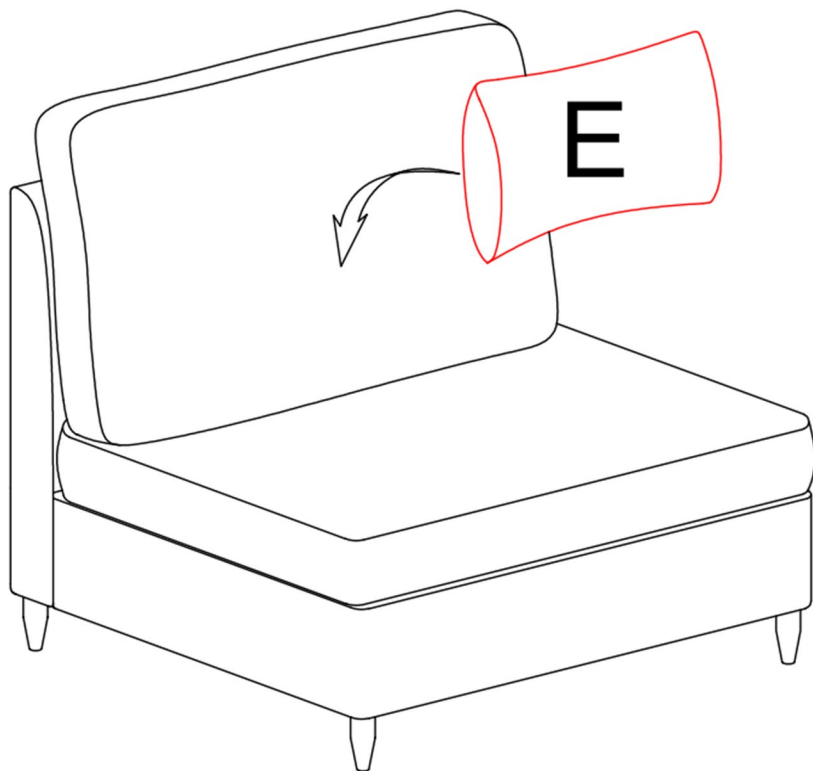

step 7 ---Install the metal hook

There is a metal buckle inside the carton as a free part.
If you only purchased single part of the sofa, this buckle will not be useful.

If you want to be combined with other sofa components (ottoman, chair ,chaise etc), this buckle can be used. Just use this buckle to fix two parts together from the bottom to prevent displacement while using the products.

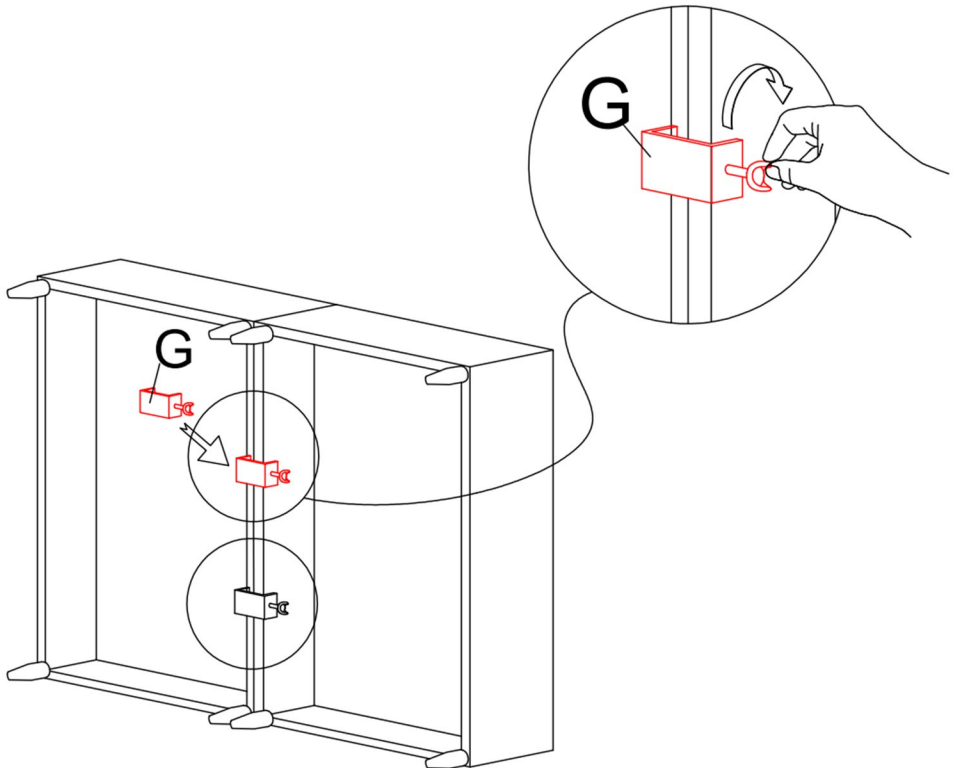



ASSEMBLY INSTRUCTIONS

Tel.(562)-781-3327

Please contact us:info@firstopintl.com

<https://www.dreamsidea.com>