

# Assembly Instructions

## Log Holder

**Caution: You must read this before you proceed**

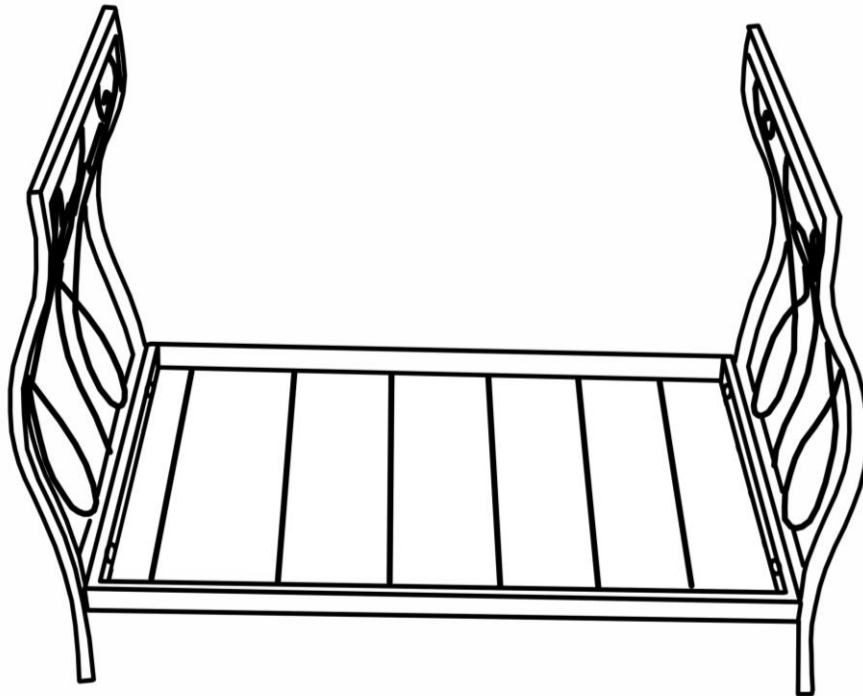



**CAUTION :** This tool is NOT a TOY.  
Keep your child / children at bay in the process of assembly.

### Parts List

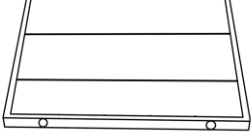
| Label | Picture | Description | QTY |
|-------|---------|-------------|-----|
| A     |         | Left Frame  | 1   |
| B     |         | Right Frame | 1   |

|   |   |      |   |
|---|---|------|---|
| C |  | Base | 1 |
|---|---|------|---|

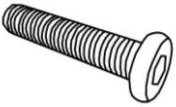
## Hardware

| Label | Picture   | Description   | QTY |
|-------|---|---------------|-----|
| ①     |  | Bolt(M6*20mm) | 5   |
| ②     |  | Spanner(M6)   | 1   |

## Assembly Preparation

Before Beginning Assembly:

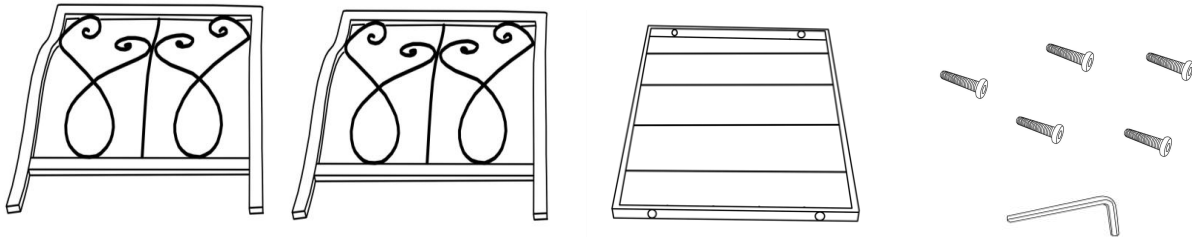

- Read instructions, cover to cover-



- Have 2 adults on hand for assembly-



- Do not assemble on flooring or carpet-



- Assemble on a clean non-marring surface (packing foam)-



- Save all packaging until finished-

## Assembly Steps

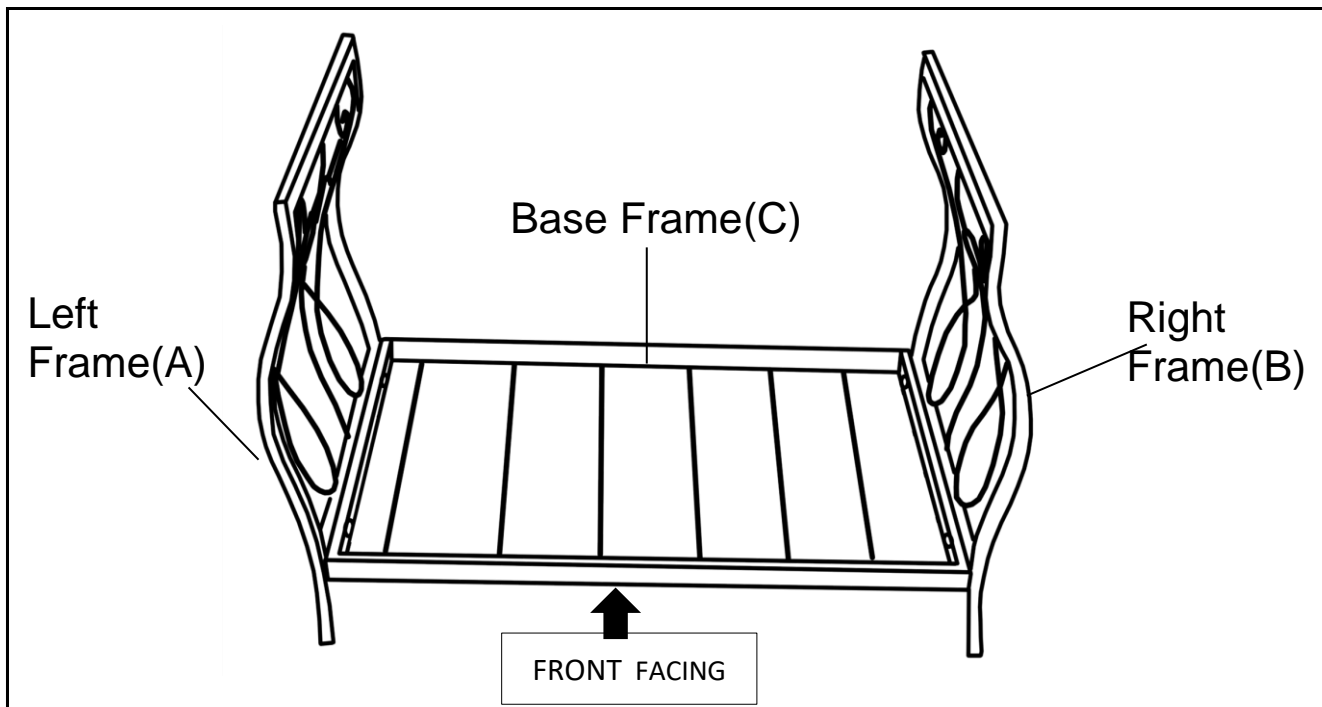

This Log Holder has multiple parts and may require up to some 30 minutes to assemble.

To give you an overview of the Log Holder parts, the above picture is to help you put the various parts into perspective.

Please read through the instructions herebelow to familiarise the parts and steps before assembly.

### Step 1

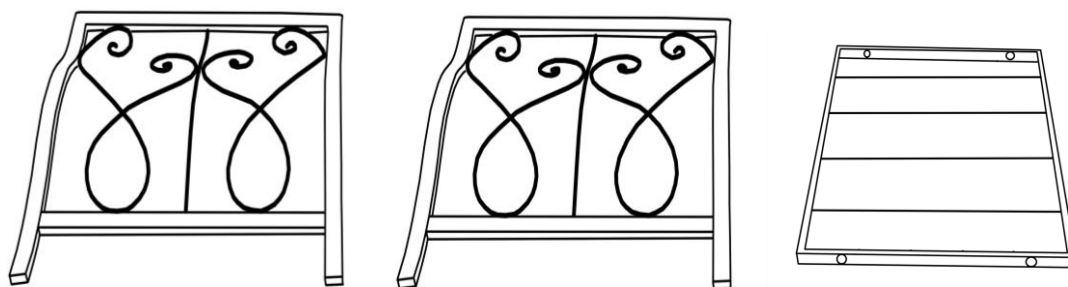

Unpack and place all parts on a clean soft surface.

Put the Left Frame(A) , Right Frame(B) , Base Frame(C) upside down as show.

## Step 2

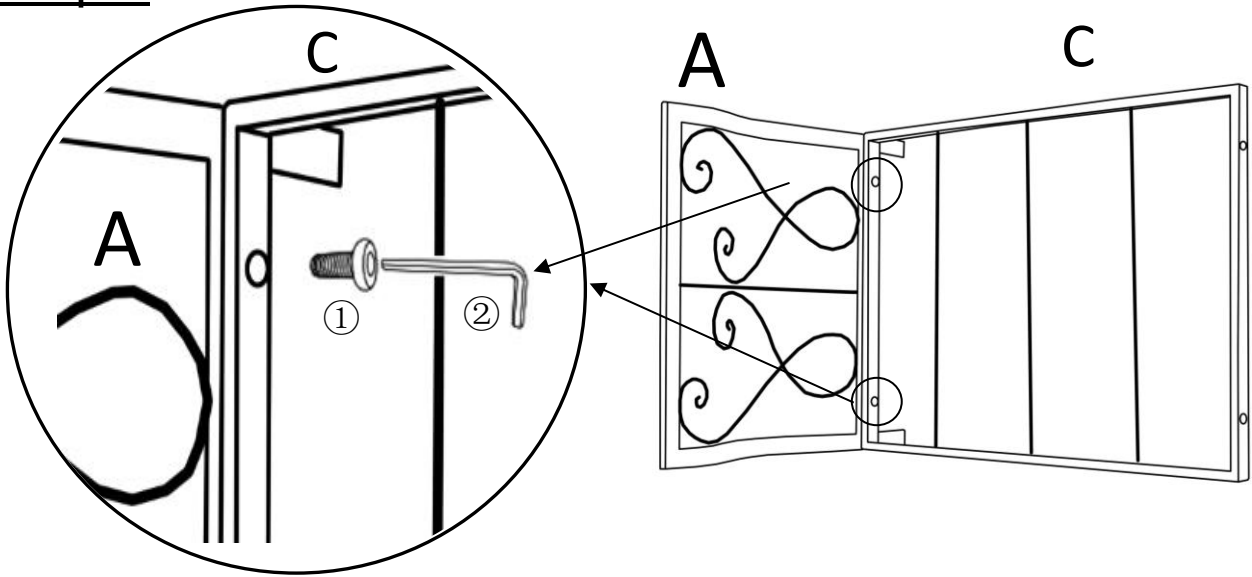

Attached Base frame(C) to Left Frame (A) using Bolt(①) with Allen Key(②).

**Loosely tighten Bolts .**

## Step 3

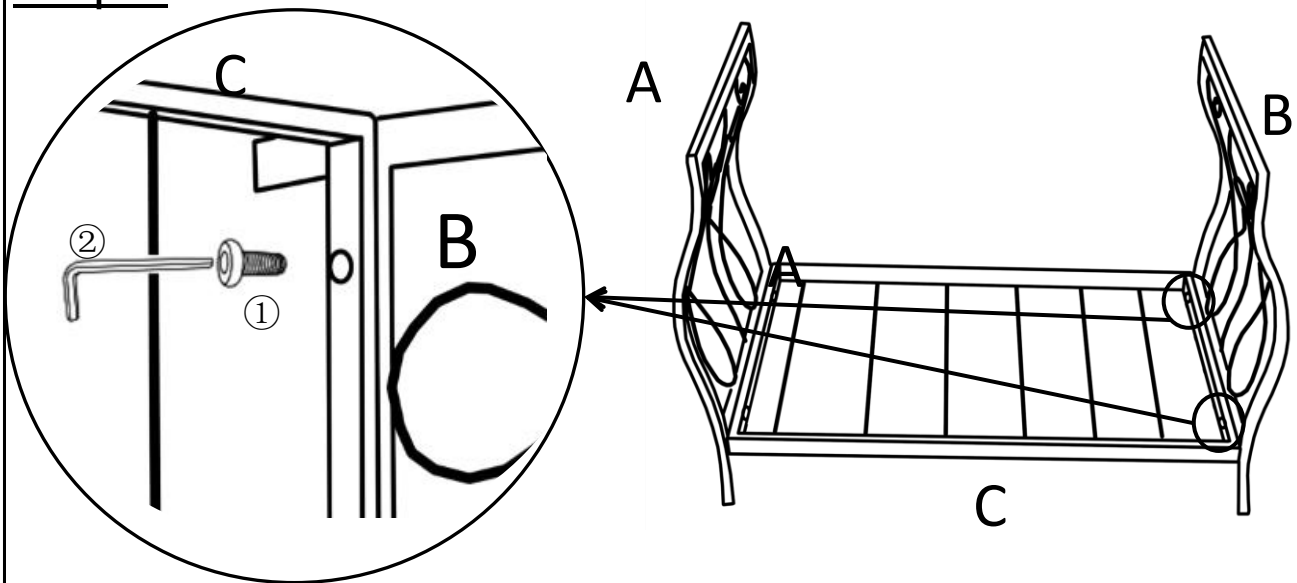

Repeat Step 2 to assemble Right Frame(B) using Bolt(①) with Allen Key(②).

**Tighten all Bolts .**

Step 4

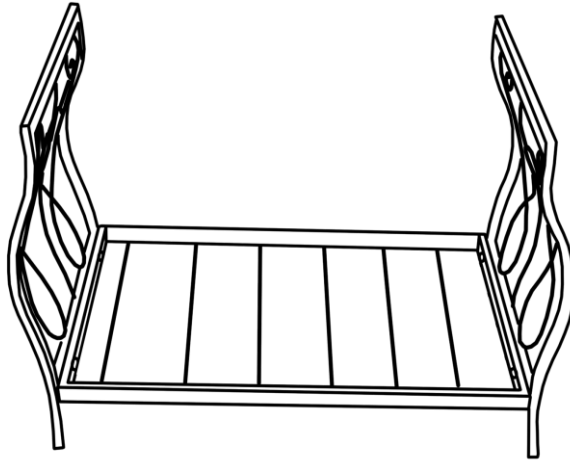

Your Log Holder is ready for use.

## Care & Maintenance

- ⊘  • Do not put hot items directly on furniture surface.
  - ⊘  • Do not clean furniture with harsh cleansers or polish.
  - ✓  • To obtain the longest lifespan of your outdoor products, minimizing exposure to direct sunlight is recommended.
  - ⊘  • Children should not climb or jump on the furniture.
  - ⊘  • Do not write on furniture without a padded barrier to protect the surface.
  - ✓  • To obtain the longest lifespan of your outdoor products, avoid extended and lengthy exposure to rain, snow, and direct sunshine. Whenever possible cover the product and /or place under patio or awnings.
  - ⊘  • Not for commercial use. For residential use only .
  - ⊘  • Stains may be removed with mild soap solution and damp cloth.
- 
- ✓  • Dust and pick-up spills using a clean, non-colored, lint-free cloth .