

# PREPARATION

Before beginning the assembly of the product, make sure all parts are present. Compare the parts with the package contents list and hardware contents list. If any parts are missing or damaged, do not attempt to assemble the product. Tool required for assembly (included): Allen Key.

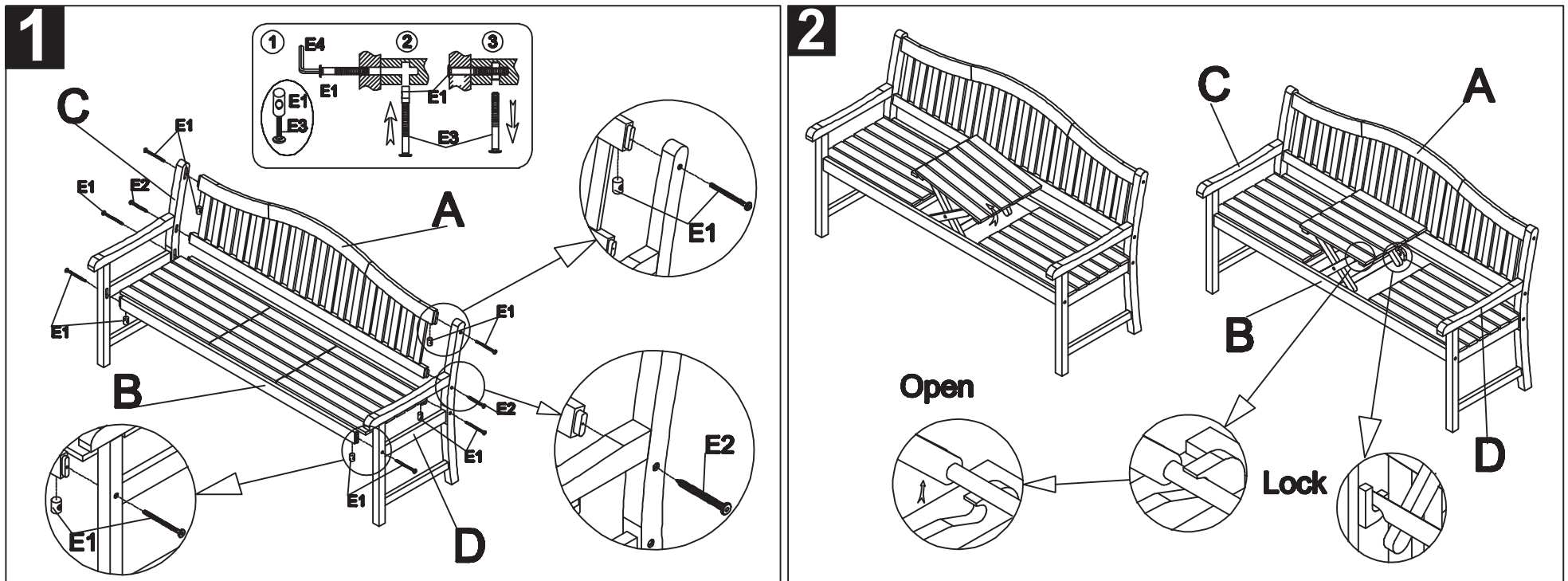

Step 1: attach the back (A) and the seat (B) to the left side (D) and right side (C) as shown on the picture. Use the Allen bolt (E1) and Allen screw (E2) to attach it together by using the Allen Key (E4).

Step 2: For using the table of the seat (B) you need to lift the table and lock it as shown on the picture. Make sure the support bar is locked before use.





## CARE AND MAINTENANCE

Store outdoor furniture indoors or cover well when it is not in use. Dust regularly with small brush or vacuum. Spills should be taken care of immediately before they harden or stain with a slightly dampened sponge.

## NOTICE

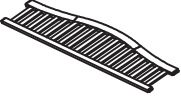
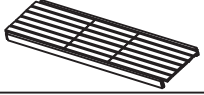
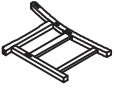
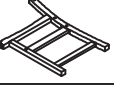
Please make sure that you have all parts indicated before you begin assembly of this item.

### Part List and Hardware List

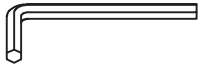
| PIECE | DESCRIPTION | PICTURE  | QUANTITY |
|-------|-------------|--|----------|
| A     | Back        |             | 1 X      |
| B     | Seat        |             | 1 X      |
| C     | Right side  |            | 1 X      |
| D     | Left side   |           | 1 X      |
| E 1   | Allen bolt  | <br>M6x70 | 6 X      |
| E 2   | Allen screw | <br>M6x70 | 2 X      |
| E 3   | Extra bolt  | <br>M6x50 | 1 X      |
| E 4   | Allen Key   |           | 1 X      |

Product Dimension: 62.99"W x 25.2"D x 37.8"H

Weight capacity : 600 lbs.

Warning : Do not stand on the bench

Warning : Do not torque bolts / screws

