

KATHALINA RECTANGLE WOOD CONSOLE TABLE

DESIGN # SFV6410

Assembly Instructions

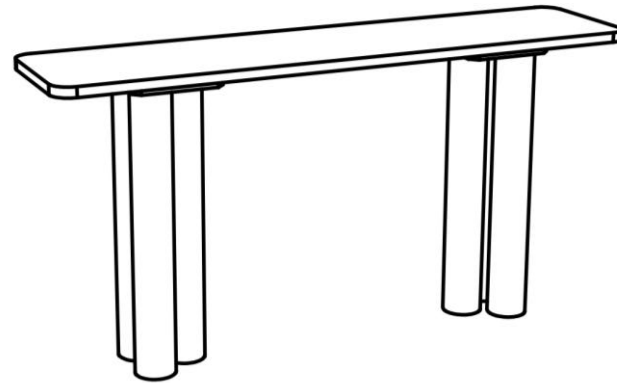

Need help?

Feel free to contact us via email or call
if you have any specific questions!

contact us:

cs@safavieh.com
866-422-9070

SAFAVIEH
C O U T U R E

Thanks for bringing Safavieh Couture into your home

Everything we make is incredibly simple to set up, including your new console table. You won't need any additional tools.

Parts List

A X 1
Top

B X 2
Base

C X 6
Legs

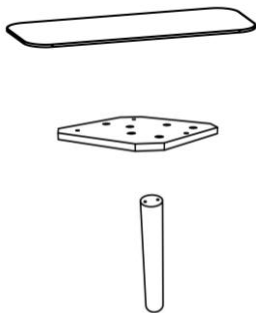

Hardware List

HW1 X 18
Allen Bolt (8x1.25x30mm)

HW2 X 18
Metal Washer (8x20mm)

HW3 X 1
Allen Key (5mm)



1 Place 3 of the legs (C) upright on a soft surface. Align the screw holes on the 3 legs (C) to the screw holes on the base (B).

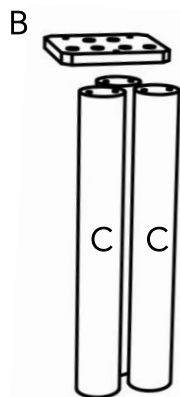

2 Place the metal washers (HW2) on the Allen bolts (HW1). Attach the legs (C) to the base (B) by using the Allen key (HW3) to screw in the Allen bolts (HW1) with the washers (HW2). Make sure that all the legs are securely attached. Repeat step 1-2 for the remaining 3 legs (C) and the remaining base (B).

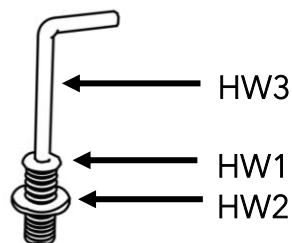

3 Lay the table top (A) upside down on a soft and clean surface.

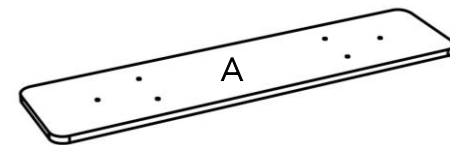

4 Attach the assembled legs to the table top (A) by using the Allen key (HW3) to screw in the Allen bolts (HW1) with the washers (HW2). Make sure all the screws are fully tightened.

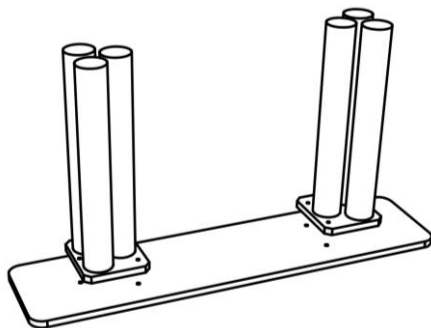

5 Carefully turn the assembled console table upright and place it in your desired spot within your home.

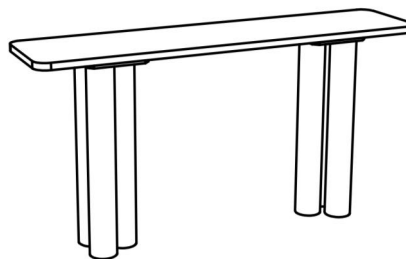

6 We'd love to see it - just tag us (we're @safavieh) and use the hashtag #safavieh on Instagram!

@safavieh