

INSTALLATION

Product Manual

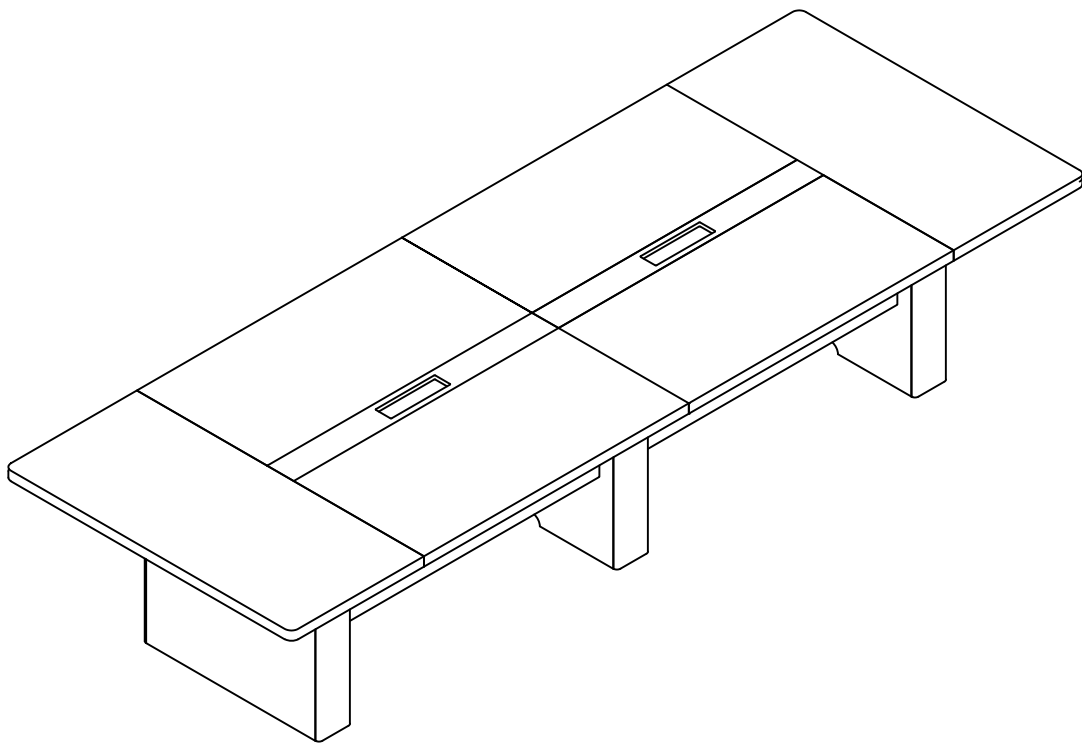



Product name: 11.8 FT CONFERENCE TABLE

Product Size: 141.7 X 51.2 X 29.5 INCH

Conference Table – Installation & Safety Instructions

English Version (U.S.)

 **Check Parts:** Open the package and verify all tabletop panels, legs, screws, and accessories are complete and undamaged. Compare with the included checklist. If any part is missing or damaged, contact the seller immediately.

 **Tools Needed:** Prepare a Phillips screwdriver, small wrench, and rubber mallet. You may use a power screwdriver at low speed, but hand-tighten all screws at the end to ensure stability.

 **Team Assembly:** Due to the large tabletop size, at least 2 people are required for lifting and assembly. Never attempt to move or install it alone to avoid injury or damage.

 **Area Setup:** Choose a wide, flat area. Keep the workspace clean and assemble near the final placement location to reduce moving distance.

 **Protection:** Place a soft cloth or cardboard on the floor. Position the tabletop face down during installation to prevent scratches.

 **Screw Installation:** Align screws straight with pre-drilled holes. Insert screws two-thirds, adjust alignment, and then fully tighten to ensure stability. Avoid over-tightening.

 **Safety:** Keep children and pets away. Work in a dry, stable environment. Be careful with tools and sharp edges.

 **Cooperation:** One person supports the tabletop while another secures the legs and beams. Always flip the table upright with at least two people.

 **Stability Check:** After installation, check all screws are tight and legs are level. Adjust leveling feet if needed.

 **Cleaning:** Wipe with a dry, soft cloth. Avoid wet cleaning or harsh chemicals.

 **Humidity:** Maintain indoor humidity at 40–60%. Avoid excessive moisture or dryness to prevent warping or cracking.

 **Sunlight:** Avoid direct sunlight exposure to prevent fading or cracking. Use curtains or blinds if necessary.

 **Load Capacity:** Do not stand or place overly heavy objects on the tabletop. Distribute weight evenly.

 **Maintenance:** Check screw tightness every few months and retighten if loose.

 **Child Safety:** Keep small children away during assembly and daily use. Do not allow children to climb or play on the table.



















 **Read Carefully:** Please read all instructions thoroughly before installation.

 **Installation Questions:** If you have any questions during assembly, contact the seller for guidance.

 **Returns:** As this is a large item, contact the seller before returning to confirm the return address and method. Keep packaging intact to avoid transport damage.

 **Replacement Parts:** If parts are missing or damaged, contact the seller for free replacement or reshipment.

Versión en Español (Adaptada al consumidor español)

-  **Verifique las piezas:** Abra el paquete y asegúrese de que todas las piezas estén completas y sin daños. Si falta alguna, contacte al vendedor.
-  **Herramientas:** Prepare un destornillador Phillips, una llave pequeña y un martillo de goma. Puede usar un destornillador eléctrico a baja velocidad, pero apriete los tornillos a mano al final.
-  **Montaje en equipo:** Se necesitan al menos 2 personas para montar y voltear la mesa. No lo haga solo.
-  **Área:** Monte la mesa en una superficie plana y limpia, cerca del lugar donde quedará.
-  **Protección:** Coloque un paño o cartón suave debajo para evitar arañazos.
-  **Tornillos:** Inserte recto y apriete solo después de ajustar todas las piezas.
-  **Seguridad:** Mantenga alejados a los niños y las mascotas. Trabaje con cuidado.
-  **Cooperación:** Una persona sostiene la tabla mientras la otra instala las patas. Voltee la mesa con ayuda.
-  **Verificación:** Asegúrese de que la mesa esté estable y los tornillos apretados.
-  **Limpieza:** Use un paño seco y suave. Evite productos químicos fuertes.
-  **Humedad:** Mantenga una humedad interior del 40–60%.
-  **Sol:** Evite la exposición solar directa para prevenir decoloración.
-  **Peso:** No se siente ni coloque objetos pesados sobre la mesa.
-  **Mantenimiento:** Revise los tornillos regularmente y apriételos si es necesario.
-  **Seguridad infantil:** Mantenga a los niños alejados durante el montaje y uso.
-  **Lea atentamente las instrucciones antes de comenzar la instalación.**
-  **Preguntas de instalación:** Si tiene dudas, contacte al vendedor.
-  **Devolución:** Contacte al vendedor antes de devolver el producto. Conserve el embalaje original.
-  **Repuestos:** Si faltan piezas o están dañadas, el vendedor enviará reemplazos gratuitos.

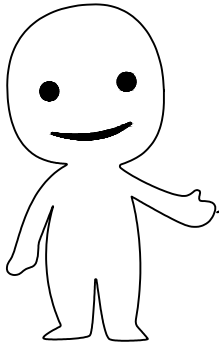

Please prepare the following tools

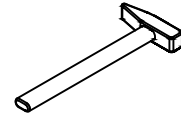
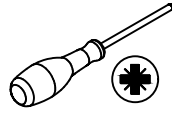
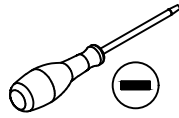

When installing, please carefully confirm whether each screw corresponds to the manual, accessories with similar shapes can be distinguished by size

A x 56



B x 56



C x 64



15A

D x 40



∅8 x 30 mm

E x (20+20)

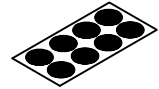

F x 12



40x50x60mm

G x 136



M4 x 16 mm

H x 12



M6 x 25 mm

I x 2



94 x 94 mm

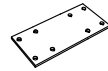

J x 10

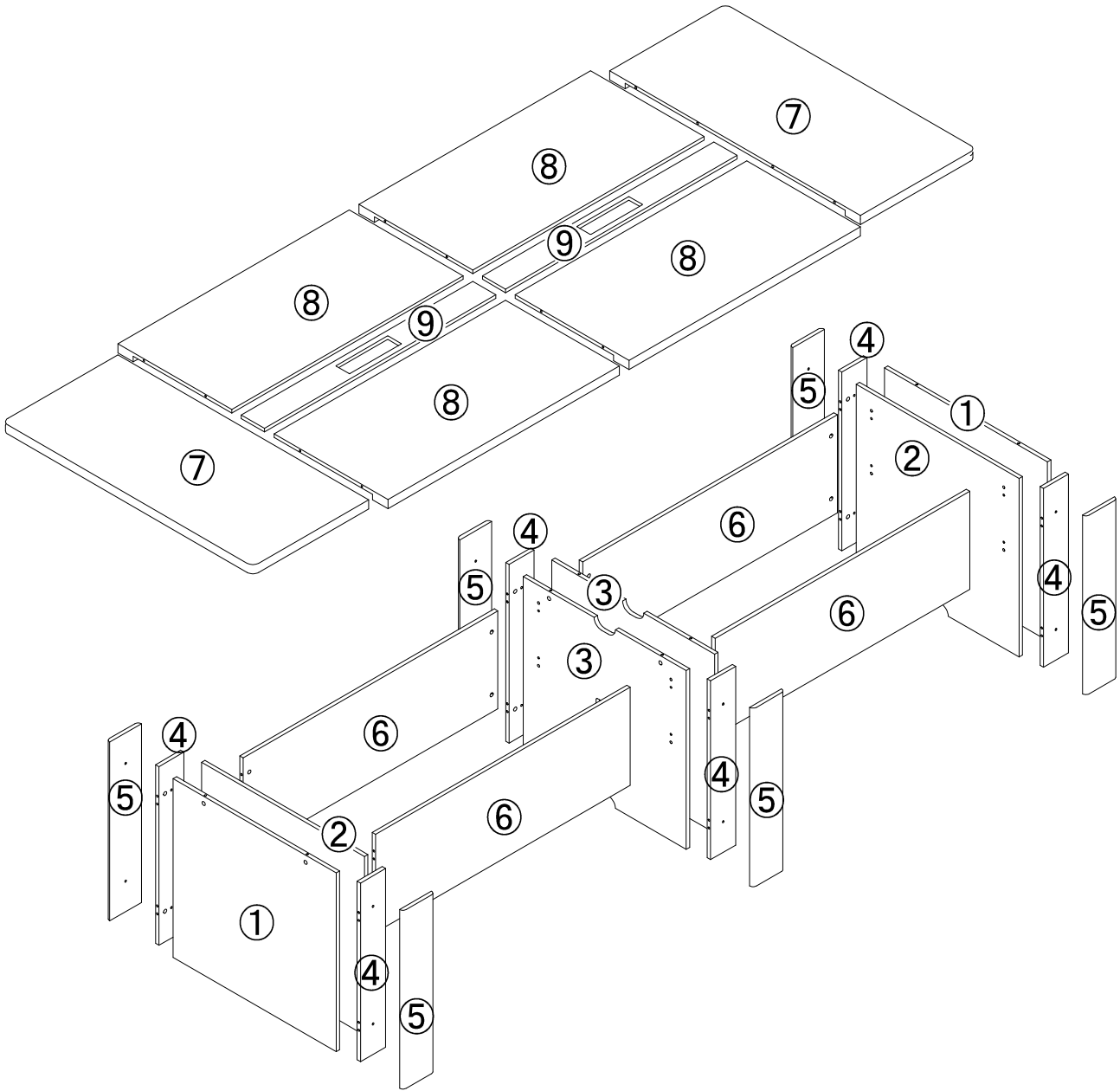

130x48x1.5 mm

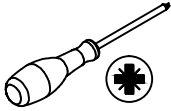

Step 1

B x 16  15A	C x 16  15A	D x 16  Ø8 x 30 mm	
--	--	---	---

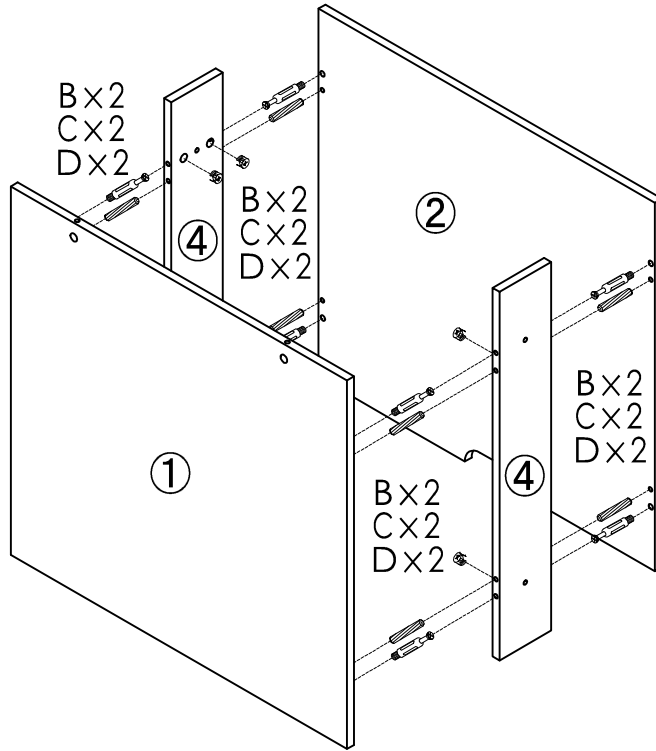

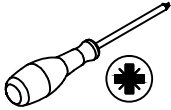

Step 2

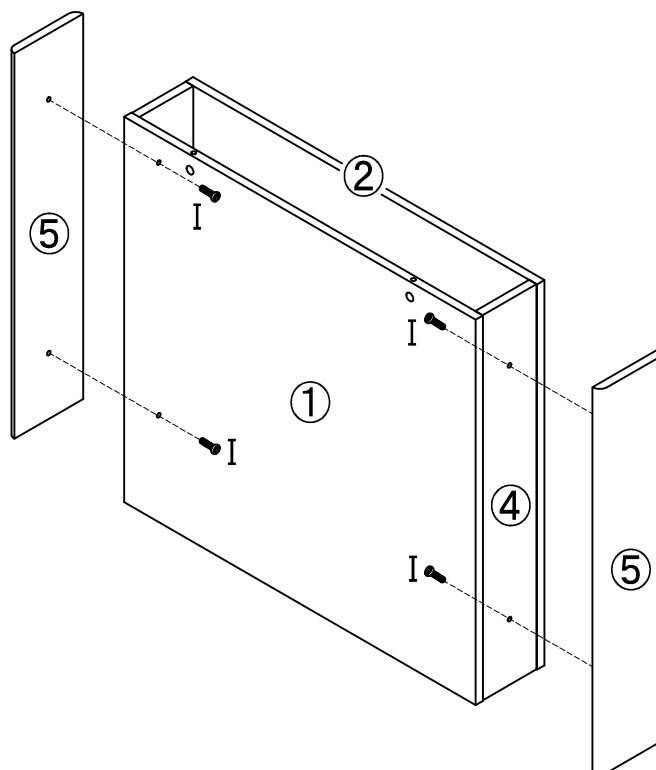
I x 8  M6 x 25 mm	
--	---

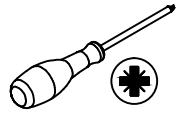

Step 3

B x 8  15A	C x 8  15A	D x 8  Ø 8 x 30 mm	
---	---	---	---

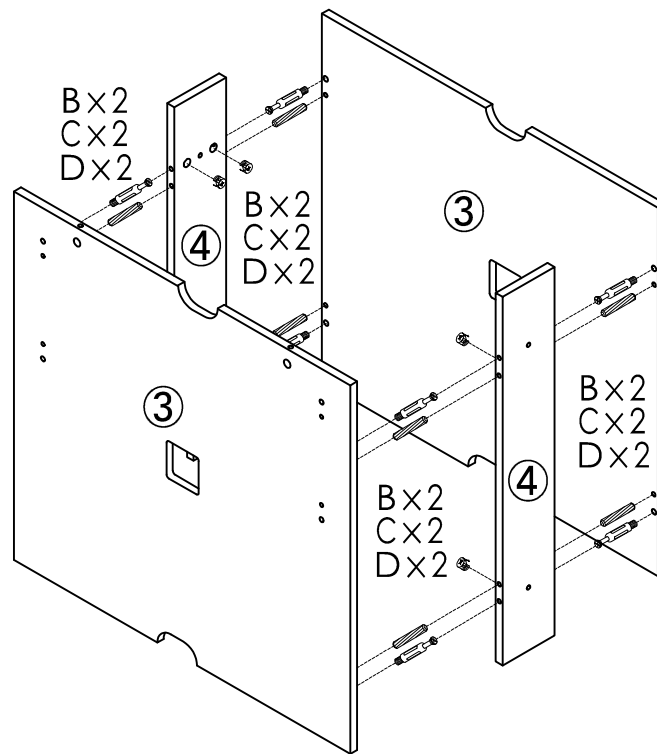

Step 4

I x 4  M6 x 25 mm	
--	---

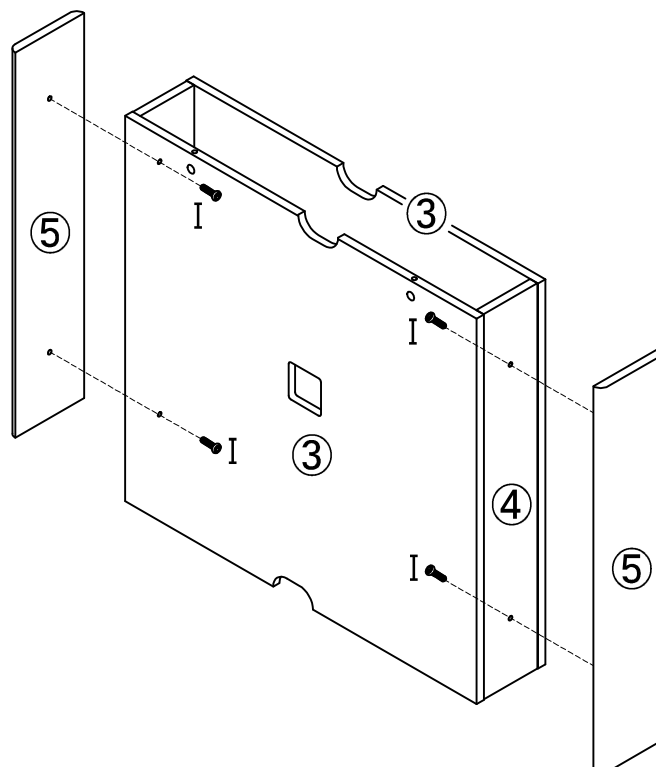

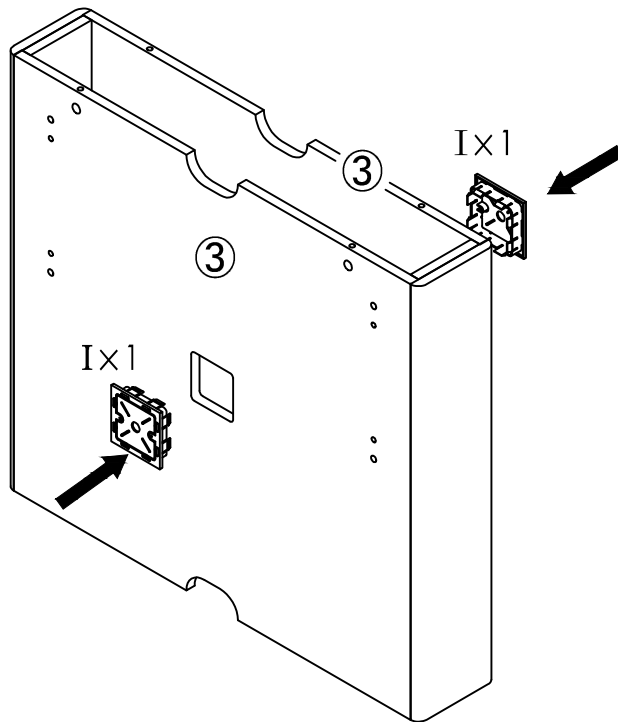

Step 5

I x 2  94 x 94 mm	
--	---





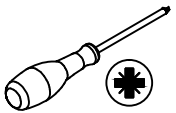

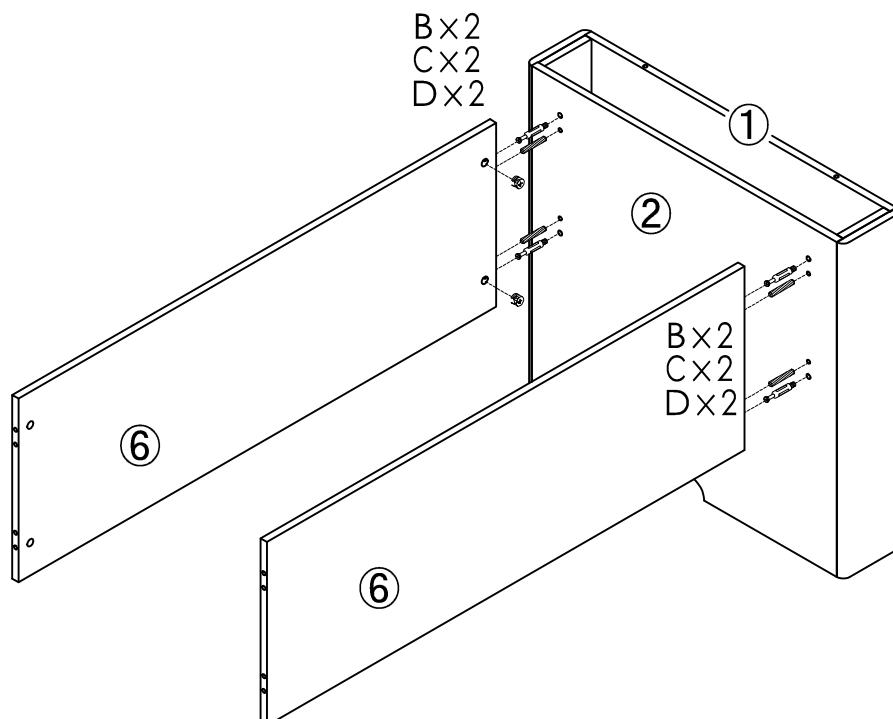
Step 6

B x 4  15A	C x 4  15A	D x 4  Ø8 x 30 mm	
---	---	--	---



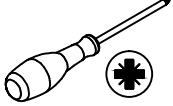

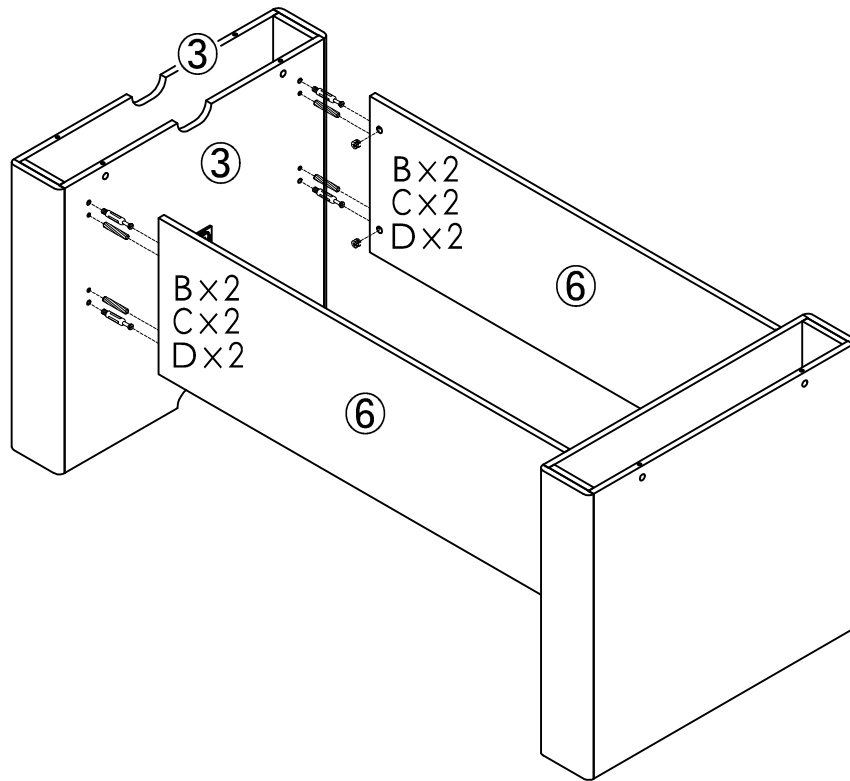

Step 7

B x 4  15A	C x 4  15A	D x 4  Ø8 x 30 mm	 
---	---	--	--



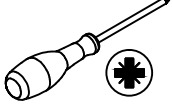

Step 8

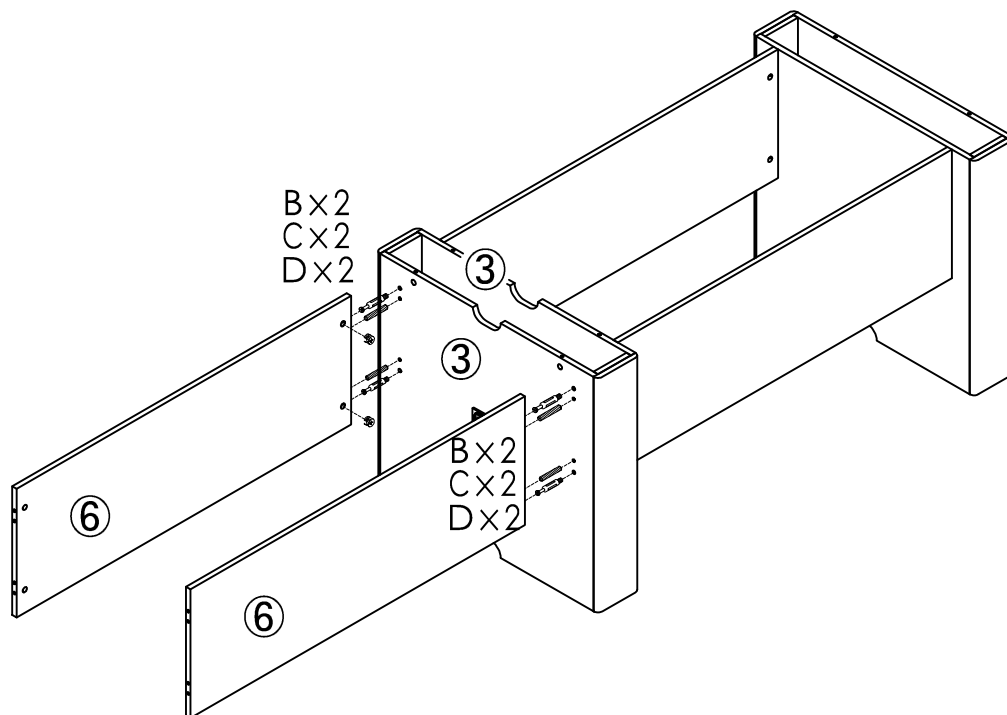
B x 4  15A	C x 4  15A	D x 4  Ø8 x 30 mm	 
---	---	--	--



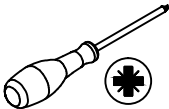

Step 9

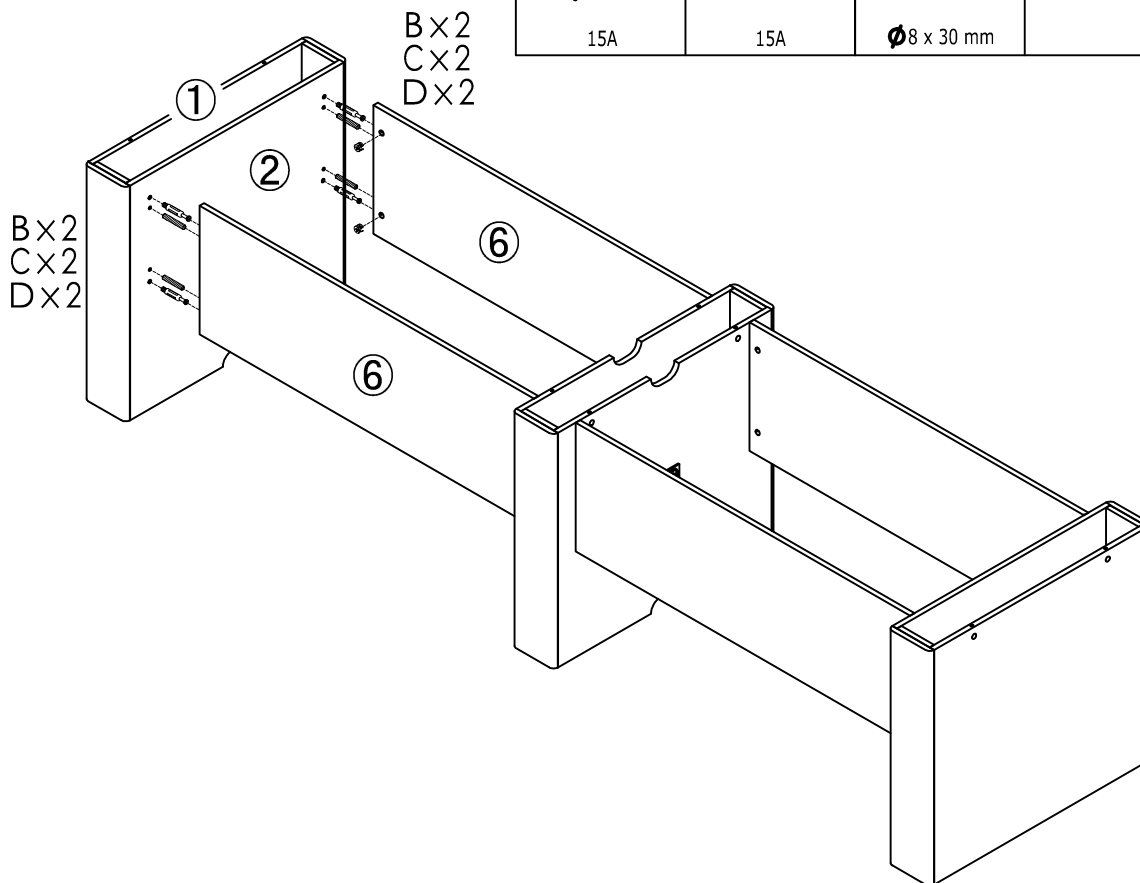
B x 4  15A	C x 4  15A	D x 4  Ø8 x 30 mm	
---	---	--	---

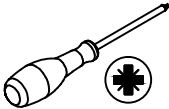

Step 10

B x 8  15A	C x 8  15A	
---	---	---

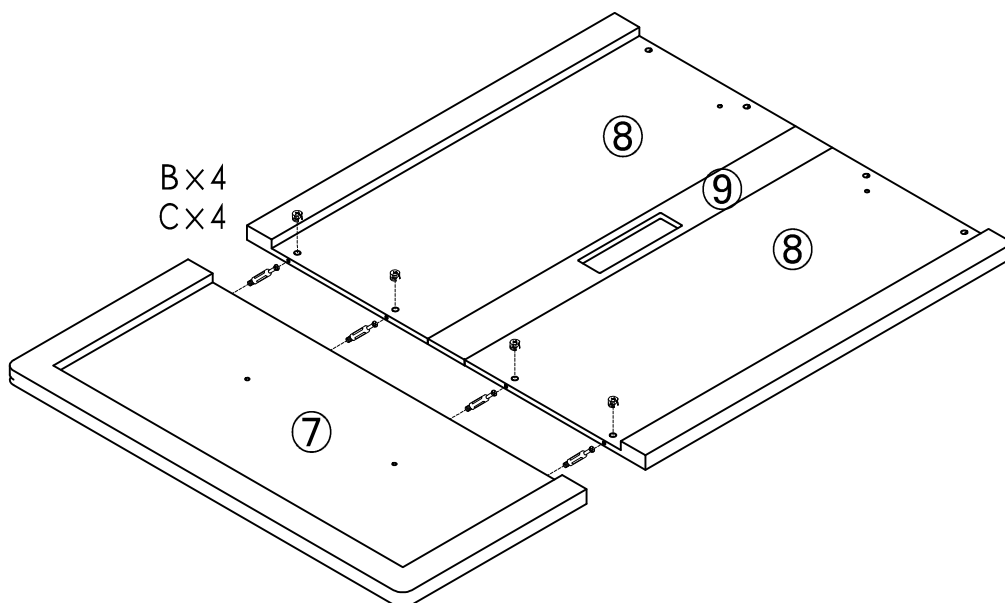

x2

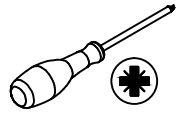

Step 11

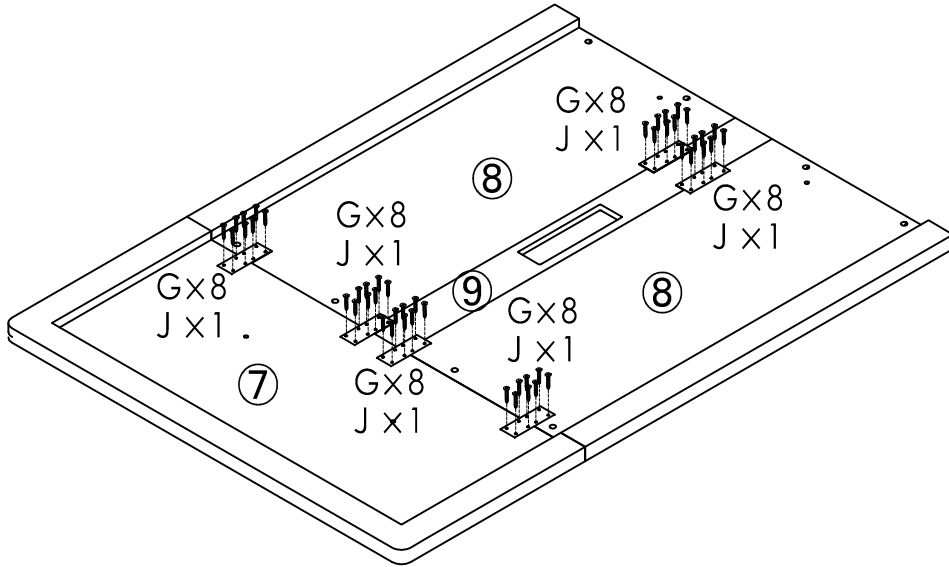
G x 96  M4x 16 mm	J x 12  130x48x1.5 mm	
--	--	---





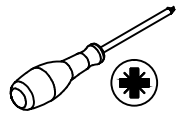

×2

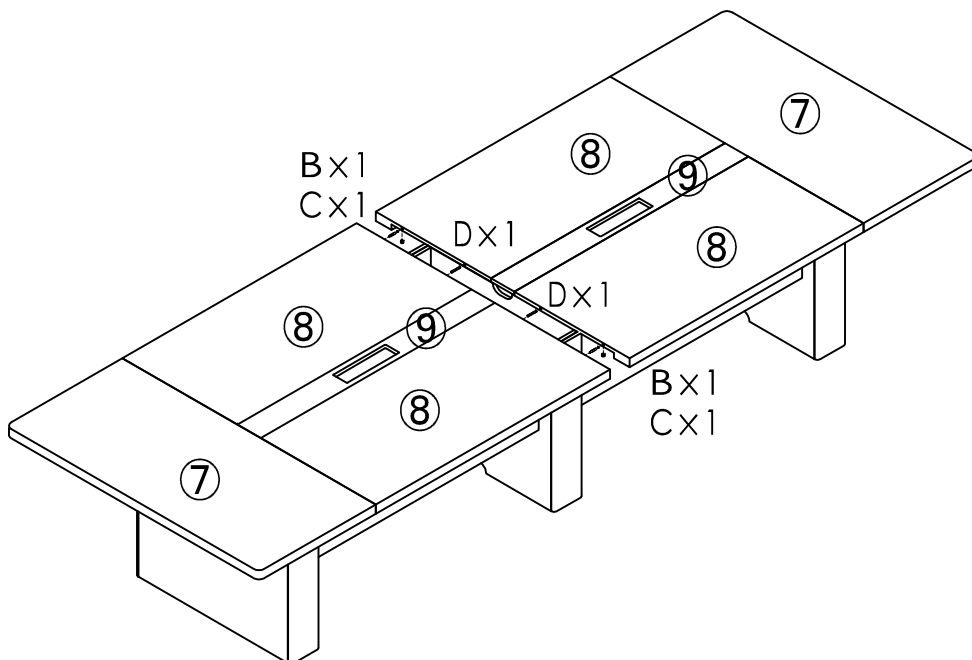
Step 12

B x 8  15A	C x 4  15A	D x 2  ∅8 x 30 mm	
---	---	--	---

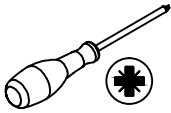

Step 13

B x 8  15A	C x 8  15A	 
---	---	--

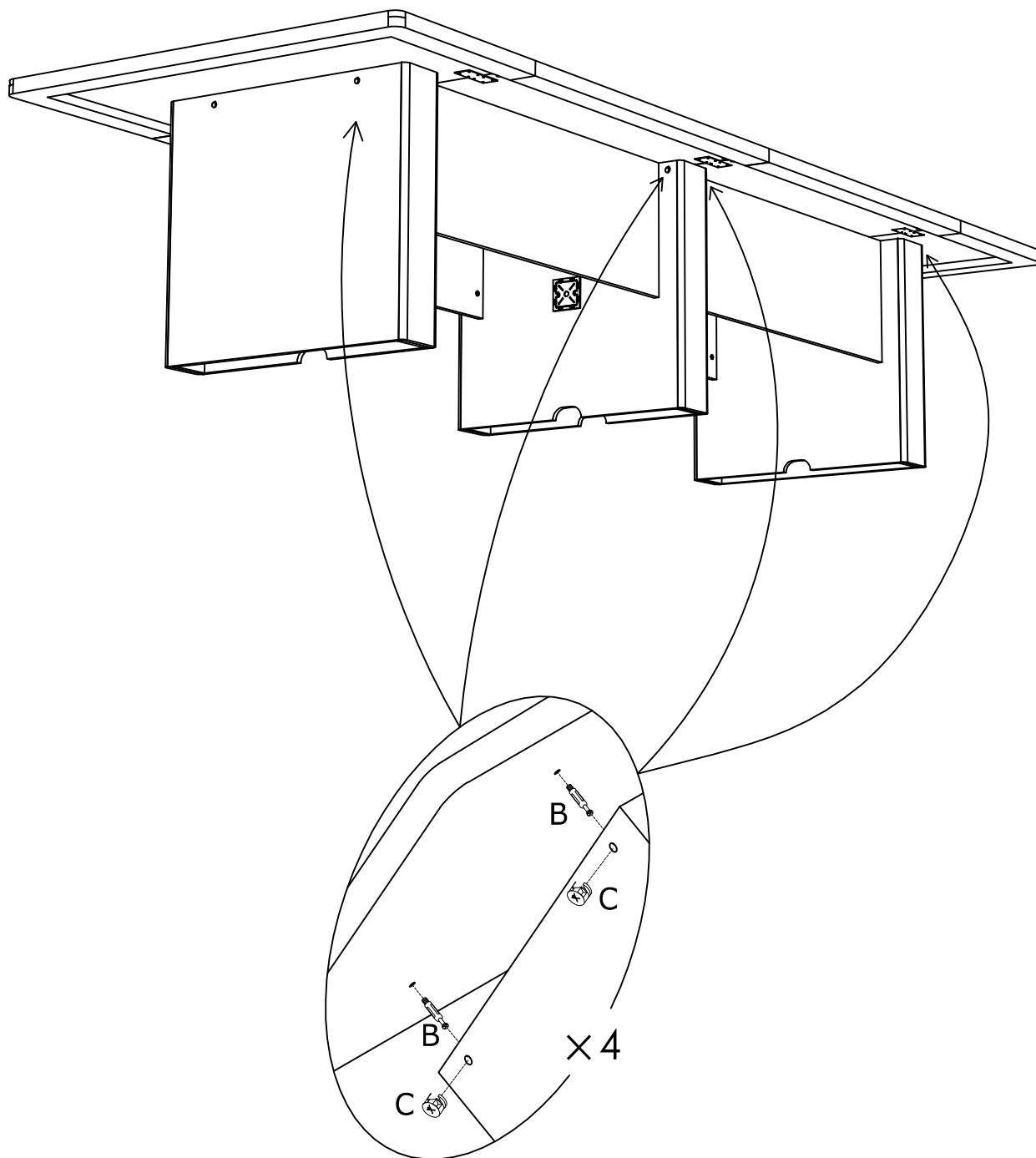

Thank You for Purchasing Our Product

Dear Customer,

Thank you for choosing our product! We sincerely appreciate your trust and support. Our mission is to craft furniture that blends functionality, durability, and elegant design to enrich your space. We hope this product brings comfort and inspiration to your workplace. Should you need any assistance or wish to share feedback, please contact us anytime – our team is here to help.

Sincerely,

Customer Support Team

Estimado cliente,

¡Gracias por elegir nuestro producto! Agradecemos sinceramente su confianza y apoyo. Nos comprometemos a crear muebles que combinen funcionalidad, durabilidad y un diseño elegante. Esperamos que este producto aporte comodidad y estilo a su espacio de trabajo. Si necesita ayuda o desea compartir sus comentarios, no dude en contactarnos.

Atentamente,

Equipo de atención al cliente

お客様へ

この度は弊社製品をお買い上げいただき、誠にありがとうございます。私たちは、機能性・耐久性・デザイン性を兼ね備えた家具づくりを通じて、お客様の空間に快適さと美しさをお届けすることを目指しています。この製品が皆様のオフィスや生活空間でお役に立てれば幸いです。ご不明点やご意見がございましたら、いつでもお気軽にお問い合わせください。

カスタマーサポートチーム

PLEASE DO NOT RETURN TO STORE



**Please do not return this product to the retailer!
We are here to assist you directly in ANY way!
If you encounter any issue with assembly, or if any part is missing or damaged, please contact our customer service team before taking further action.**

**¡NO DEVUELVA ESTE PRODUCTO A LA TIENDA!
¡Estamos aquí para ayudarle directamente en todo lo que necesite!
Si encuentra algún problema durante el montaje, o si falta o está dañado algún componente,
póngase en contacto con nuestro servicio de atención al cliente antes de tomar cualquier otra medida.**

この製品を販売店に返品しないでください!
組立の際に問題が発生した場合、または部品の不足・破損があった場合は、
まずは弊社カスタマーサービスまでご連絡ください。
お客様を直接サポートいたします!