

MODEL: IG10600047-1214

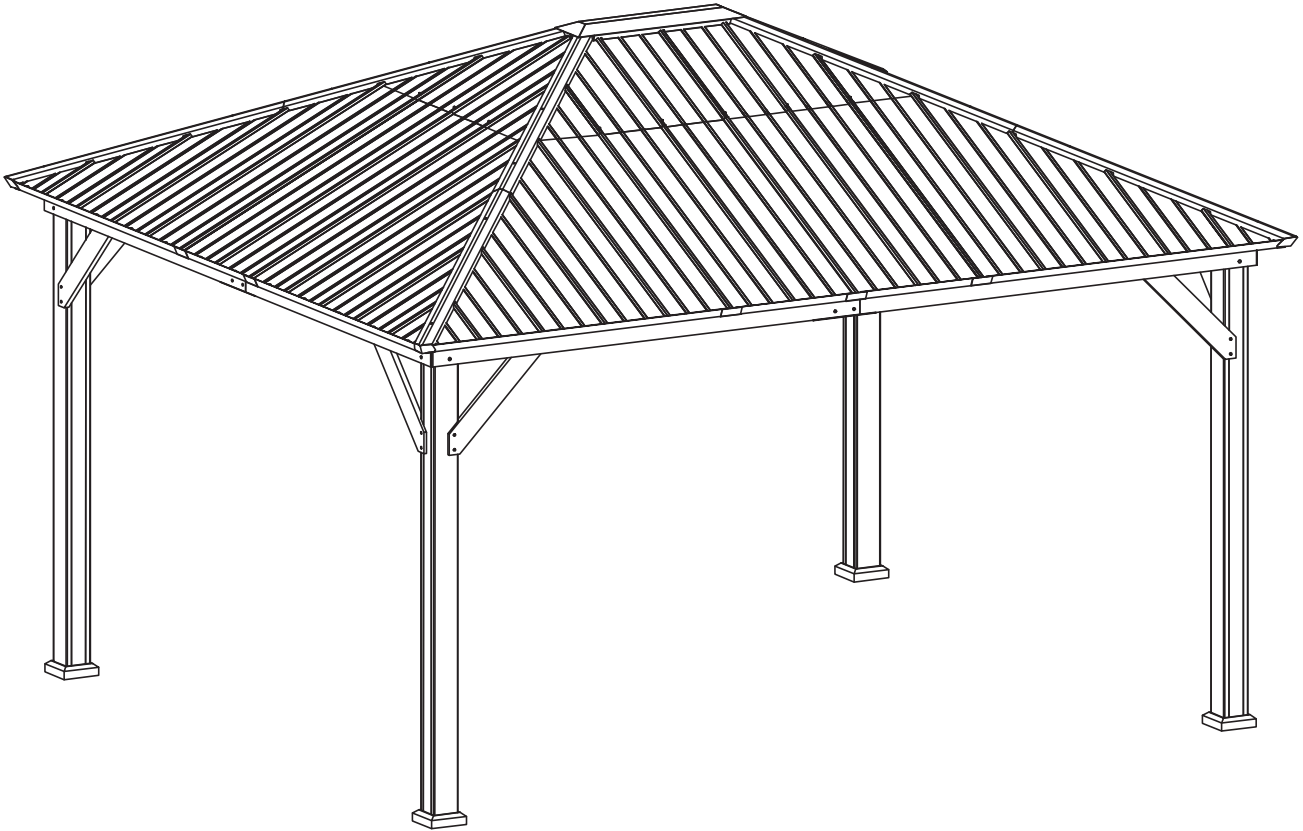

OWNER'S MANUAL

Tranquil Grove 12' x 14' Cedar Framed Hardtop Pavilion

TABLE OF CONTENTS

ASSEMBLY GUIDE.....02
USING YOUR PRODUCT.....05

December 27, 2024

QUESTIONS?



E-mail: support@modernshade.org













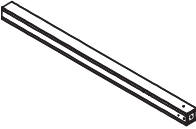

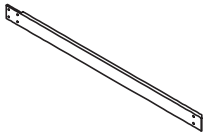
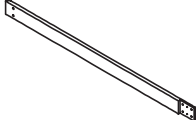
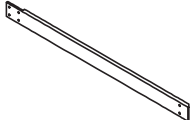
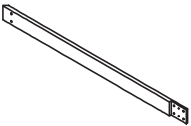
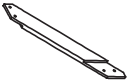

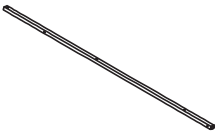
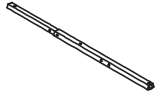

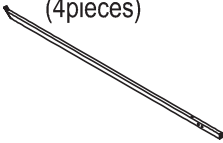
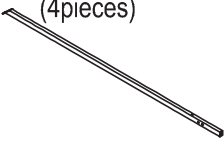
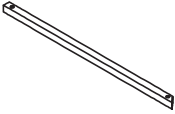

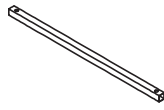
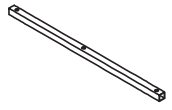

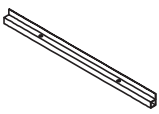
Toll Free: 1-888-666-3070

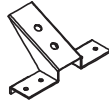

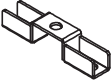
Mon-Fri: 9am---5pm PST.

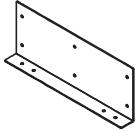
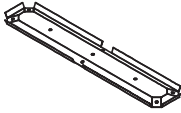
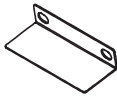
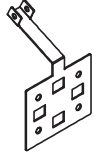
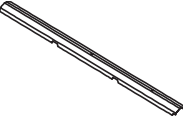
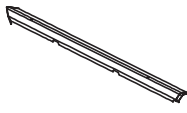
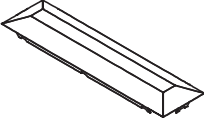
ASSEMBLY GUIDE

PARTS LIST

A1 Post 1 (4pieces) 	B Foot Base (4pieces) 	C Foot Cover (4pieces) 	D5 Cross Beam 5 (2pieces) 	D6 Cross Beam 6 (2pieces) 	D7 Cross Beam 7 (2pieces) 
P0010000701	P0030000301	P0020000301	P0040001901	P0040002001	P0040002101
D8 Cross Beam 8 (2pieces) 	E1 Support Bracket 1 (4pieces) 	E2 Support Bracket 2 (4pieces) 	F1 Roof Rib 1 (4pieces) 	F2 Roof Rib 2 (4pieces) 	G1 Middle Cross Beam 1 (2pieces) 
P0040002201	P0050000501	P0050000601	P0070000501	P0070000601	P0080000501
G3 Middle Cross Beam 3 (4pieces) 	G4 Middle Cross Beam 4 (4pieces) 	H2 Roof Support 2 (8pieces) 	H4 Roof Support 4 (8pieces) 	H6 Roof Support 6 (6pieces) 	H7 Roof Support 7 (6pieces) 
P0080000801	P0080000901	P0090000202	P0090002201	P0090000302	P0090002501
L1 Roof Border 1 (4pieces) 	L2 Roof Border 2 (4pieces) 	L9 Roof Border 9 (6pieces) 	M1 Connector 1 (2pieces) 	M2 Connector 2 (8pieces) 	M3 Connector 3 (4pieces) 
P0090001502	P0090001602	P0090001902	P0060001401	P0060001501	P0060001701
M4 Connector 4 (30pieces) 	M5 Connector 5 (12pieces) 	M6 Connector 6 (4pieces) 	M8 Connector 8 (1piece) 	M9 Connector 9 (10pieces) 	M12 Connector 12 (2pieces) 
P0060000501	P0060000602	P0110000701	P0060000702	P0110000502	P0060005201
N1 Roof Rib Cover 1 (4pieces) 	N2 Roof Rib Cover 2 (4pieces) 	N4 Roof Rib Cover 4 (1piece) 	P1 Roof Plate 1 (2pieces) 	P2 Roof Plate 2 (2pieces) 	P3 Roof Plate 3 (2pieces) 
P0120001001	P0120001101	P0120000502	P0130001501	P0130001601	P0130001701

ASSEMBLY INSTRUCTIONS

- Please carefully unpack each of the components and hardware. check the components against the parts list and make sure there are no missing parts. lay pieces on cardboard or a soft mat to help protect the pieces from scratches.

⚠ CAUTION

Watch for sharp edges when handling the pieces, wear gloves to avoid injury.

STEP 01 Slide foot base **B** and foot cover **C** onto post **A1**. Use four (4) **[AA]** bolts to attach foot base **B** to post **A1**. Repeat with the other three (3) posts **A1**.

- For ease of assembly, it is recommended to have 3 or more people and allow enough time to completely finish the assembly. assembly can take 6-8 hours. a step-ladder is required for assembly (not included).
- Follow step by step instructions, and follow all safety warnings provided with your tools.
- DO NOT tighten screws until all the screws and washers are properly installed. Tighten screws securely, do not over tighten.
- Gazebo should not be used in inclement weather and high winds.

STEP 02 Attach four (4) **[JJ]** screw nuts to cross beam **D8**. Use four (4) **[FF]** bolts and four (4) **[LL]** flat washers to attach cross beam **D7** to connector **M12** and cross beam **D8**. Repeat to make a second assembly.

[AA] x16

[FF] x8

[LL] x8

[JJ] x8

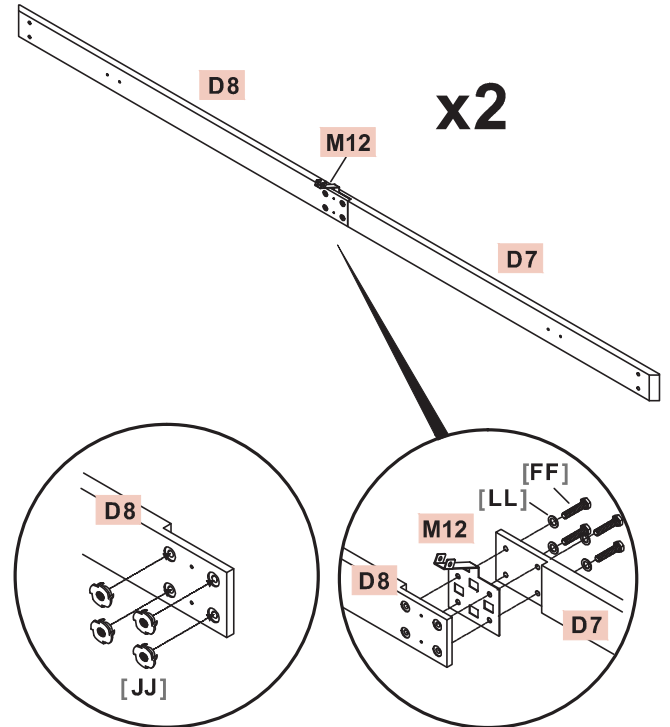
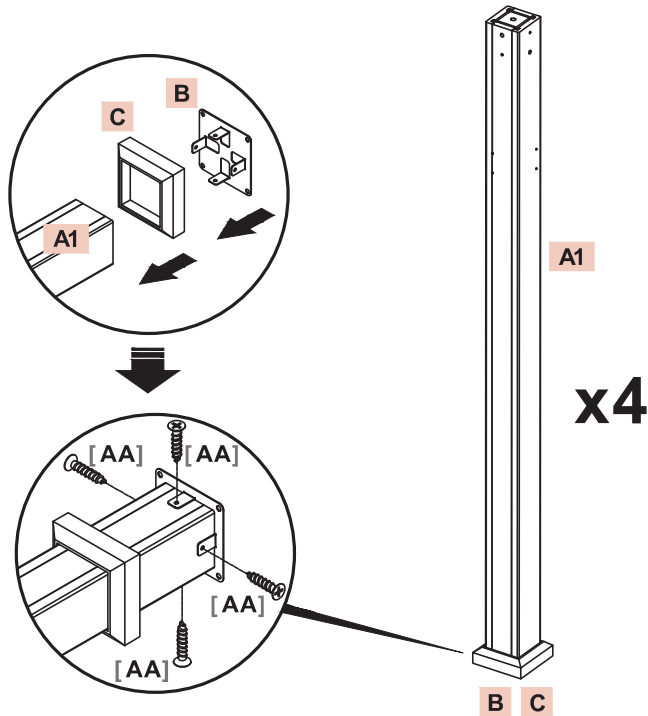

STEP 03 Use ten (10) [AA] bolts to attach each connector [M6] to cross beam assembly [D7] [D8]. Repeat to make a second assembly.

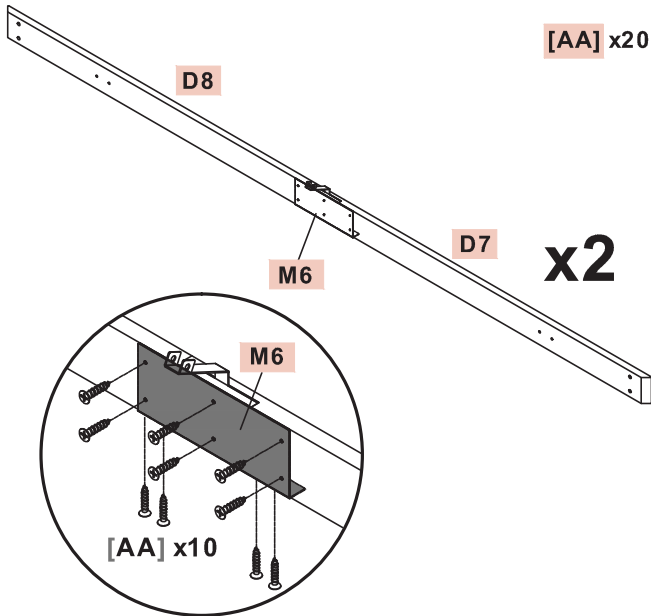

STEP 04 Attach four (4) [JJ] screw nuts to cross beam [D6]. Use four (4) [FF] bolts and four (4) [LL] flat washers to attach cross beam [D5] to connector [M1] and cross beam [D6]. Repeat to make a second assembly.

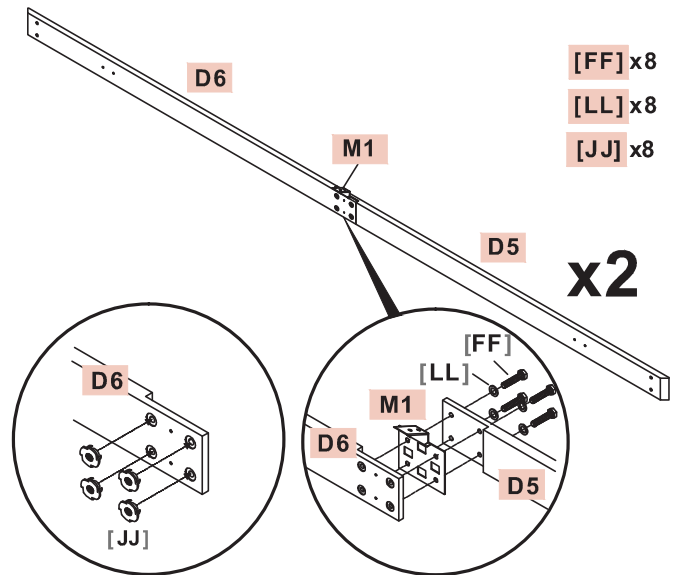

STEP 05 Use ten (10) [AA] bolts to attach each connector [M6] to cross beam assembly [D5] [D6]. Repeat to make a second assembly.

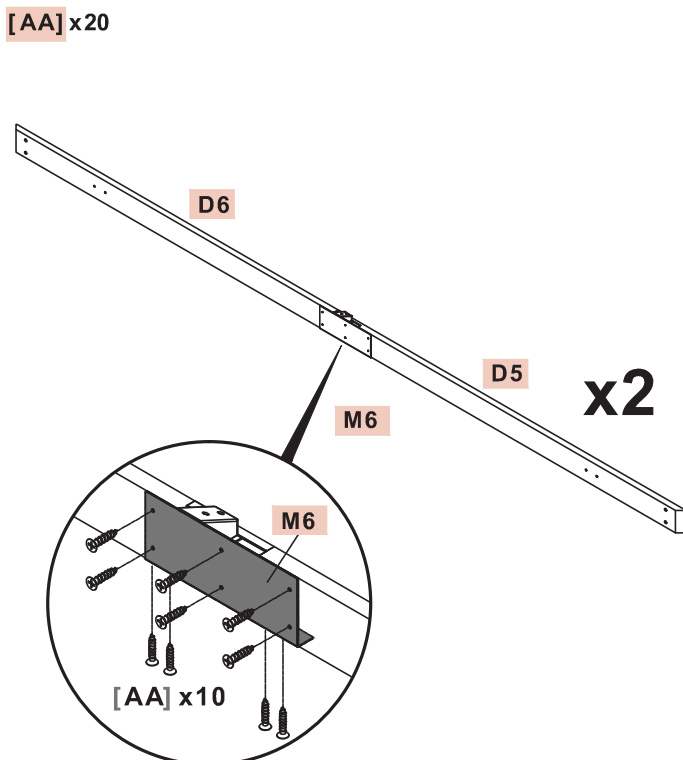

STEP 06 Attach the cross beam assembly [D7] [D8] to left [A1] post using one (1) [CC] bolt and [MM] washer in the top hole, and one (1) [GG] bolt, two (2) [MM] washers, and one (1) [HH] nut in the bottom hole. Attach the cross beam assembly to right [A1] post using one (1) [GG] bolt, two (2) [MM] washers, and one (1) [HH] nut in the top hole, and one (1) [CC] bolt and [MM] washer in the bottom hole. Repeat to make a second assembly.

