

# Assembly Instructions

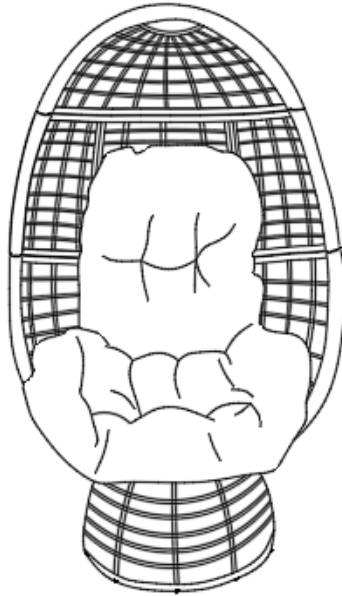



**Caution : You must read this before you proceed**

## Swivel Chair

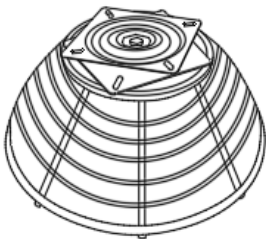
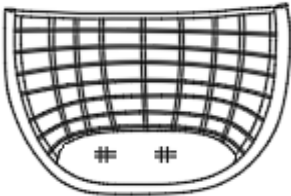

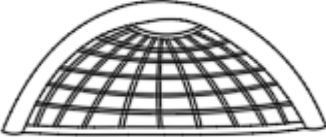

### Parts List

Label	Picture	Description	QTY
A		Swivel Plate	1
B		Seat Panel	1

C		Left Panel	1
D		Middle Panel	1
E		Right Panel	1
F		Top Panel	1
G		Cushion	1

## Hardware

Label	Picture	Description	QTY
①		Bolt (M6*16mm)	5
②		Bolt (M6*50mm)	17
③		Spring Washer	21

④		Washer (M6*14*1.5mm)	37
⑤		Nut (M6mm)	17
⑥		Nut Cap	17
⑦		Nut Cap	17
⑧		Allen Key (5#)	1
⑨		Wrench	1

## Assembly Preparation

Before  
Beginning  
Assembly:

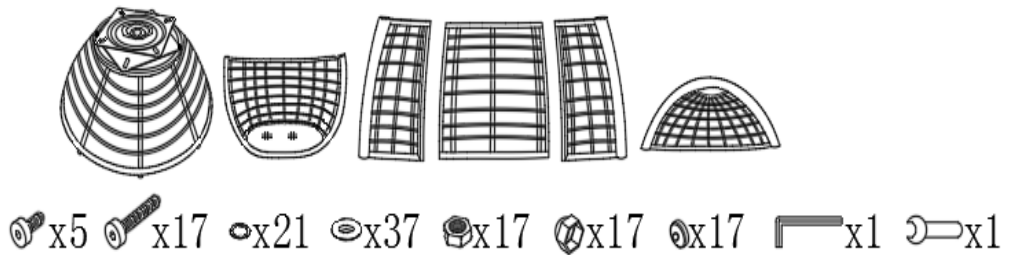

- Read instructions, cover to cover-



- Have 2 adults on hand for assembly-



- Do not assemble on flooring or carpet-



- Assemble on a clean non-marring surface (packing foam)-



- Save all packaging until finished-

# Assembly Steps

## Overview

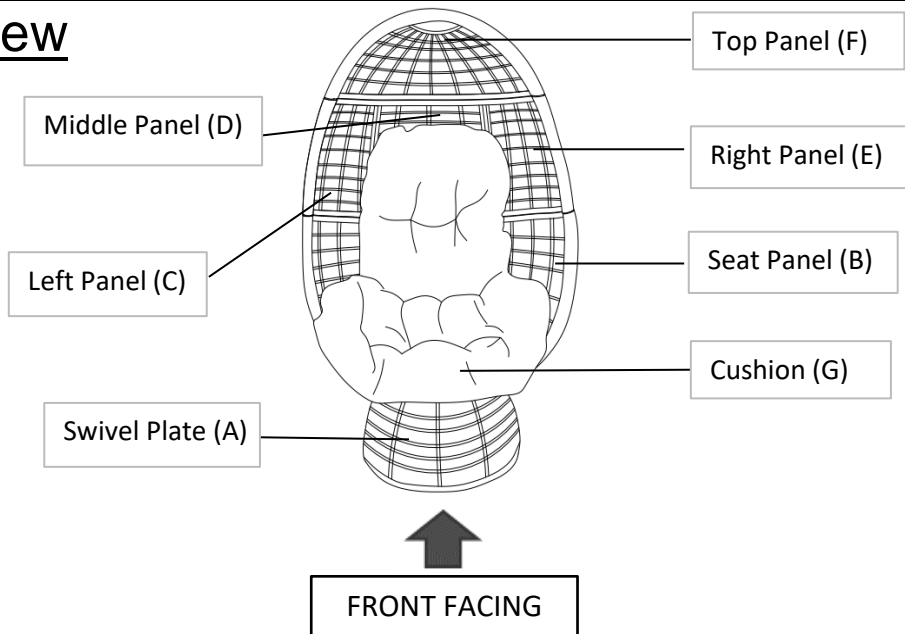

This Swivel chair has multiple parts and may require up to 60 minutes to assemble. To give you an overview of the chair parts, the above picture is to help you put the various parts into perspective. Please read through the instructions below to familiarise yourself with the parts and steps before assembly.

## Step 1

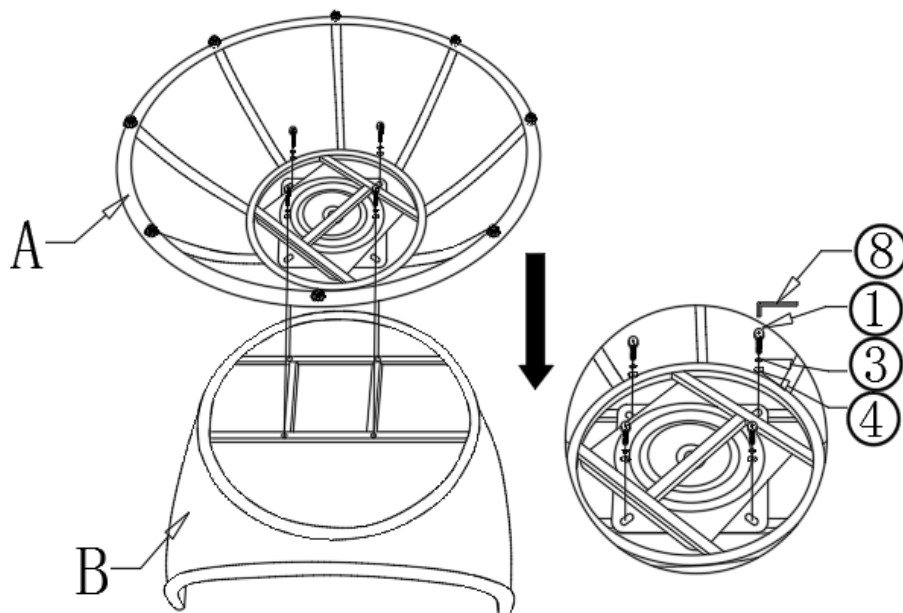

Open the carton and place all the parts onto a clean, non-marring surface.

Place Seat Panel(B) on the ground, then attach the Swivel Plate(A) to the Seat Panel(B) with Bolts (①) and Washers(③,④) with Allen Key( ⑧) as shown in picture above.

## Step 2

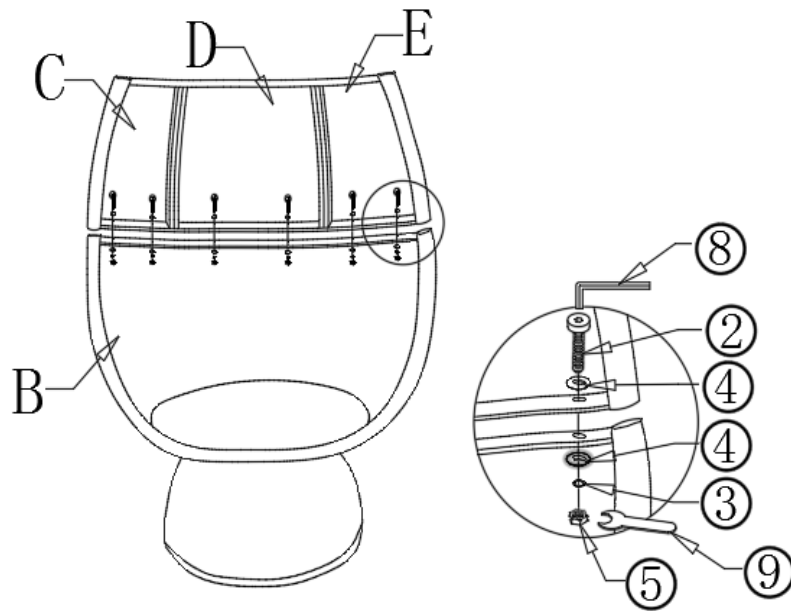

Turn the Basket Seat(A) over as shown in picture.  
Attach Left Panel(C)、 Middle Panel(D) and Right Panel(E) to Basket Seat(B) using Bolts(②), Nut(⑤ ) and Washers(③,④ ) with Allen Key( ⑧) and Wrench(⑨) as shown in picture above.  
Do not fully tighten the bolts.

## Step 3

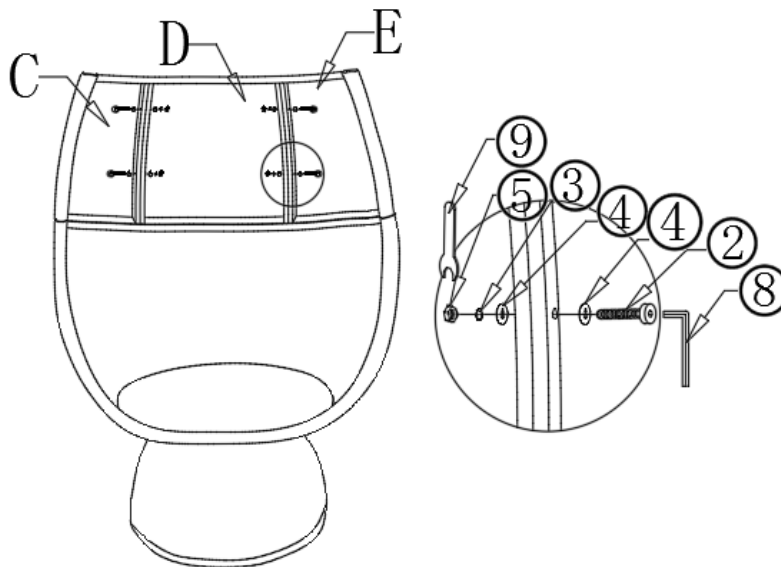

Join the Left Panel(C), Middle Panel(D) and Right Panel(E) together using Bolts(②), Nut(⑤ ) and Washers(③,④ ) with Allen Key( ⑧) and Wrench(⑨) as shown in picture above.  
Do not fully tighten the bolts.

## Step 4

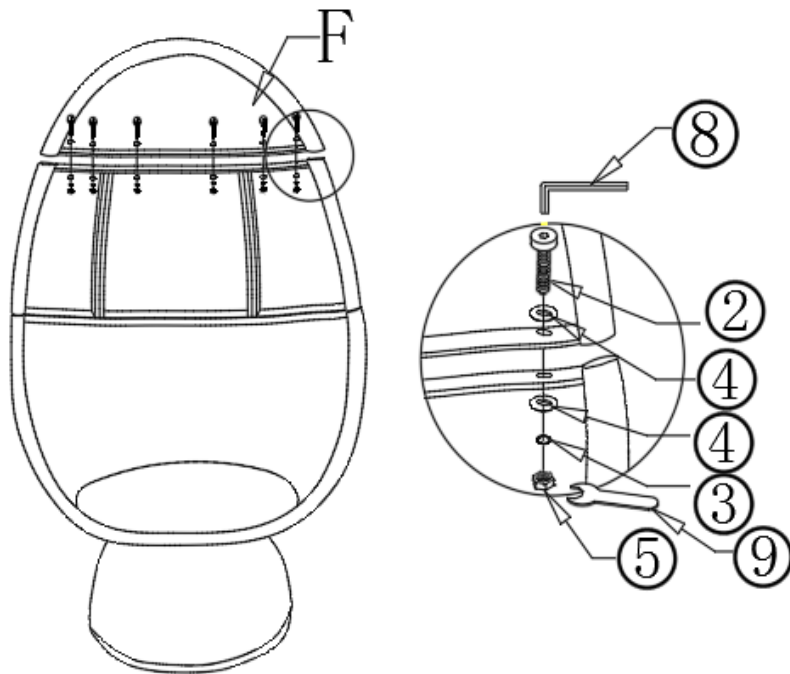

Attach the Top Panel(F) to the Left Panel(C), Middle Panel(D) and Right Panel(E) using Bolts(②), Nut(⑤) and Washers(③,④) with Allen Key(⑧) and Wrench(⑨) as shown in picture above. Do not fully tighten the bolts.

## Step 5

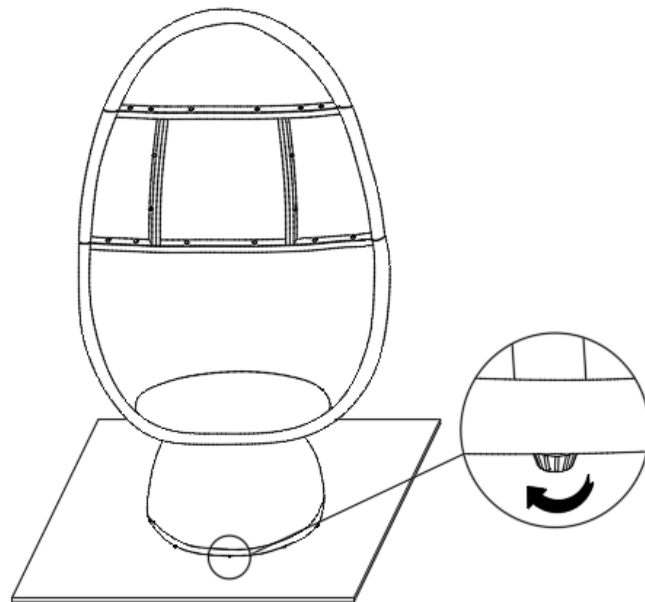

Check for stability and then tighten all Bolts at all joints.

Adjust the Legs Pre-installed Levellers until the chair level with the ground.

**Note:** DO NOT fully tighten a Bolt in one go and then move on to the next. Rather in a sequential manner, gradually tighten each Bolt until all Bolts are evenly secured.

This methodology will ensure maximum evenness once all Bolts are fully tightened.

## Step 6

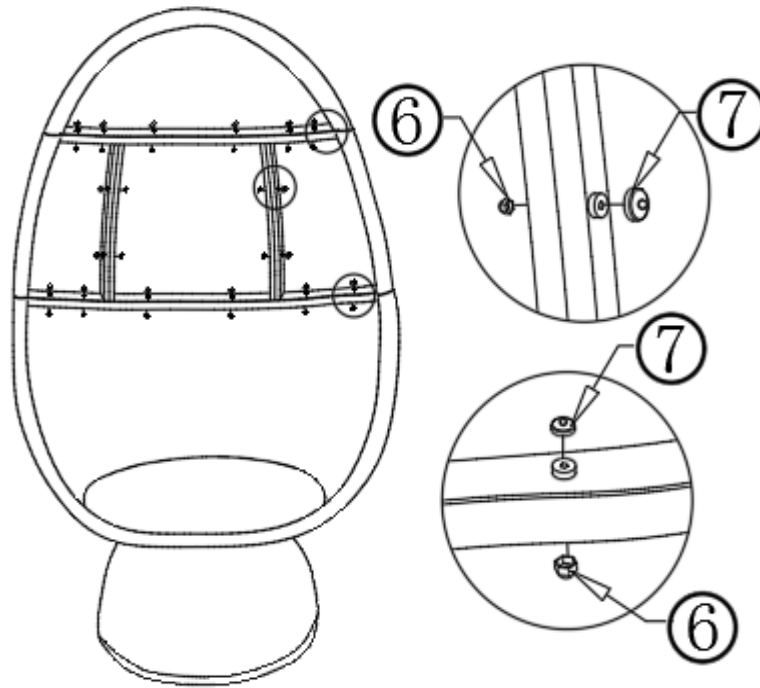





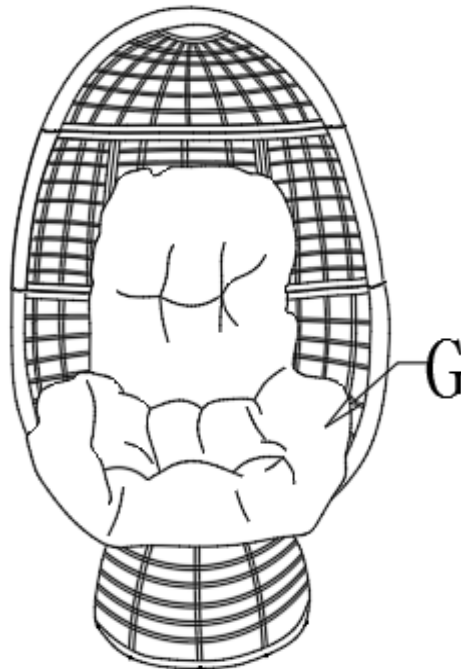















Add the Nut Caps(⑥,⑦ ) on the 16 Bolts as shown in the picture above.

## Step 7



Place the Cushion(G) on the Basket.  
Your Swivel Chair is ready for use.  
This Chair can only be used on a flat, level surface.

## Care & Maintenance

-   ● Do not put hot items directly on furniture surface
  -   ● Do not clean furniture with harsh cleansers or polish.
  -   ● To obtain the longest lifespan of your outdoor products, minimizing exposure to direct sunlight is recommended.
  -   ● Children should not climb or jump on the furniture.
  -   ● Do not write on furniture without a padded barrier to protect the surface.
  -   ● To obtain the longest lifespan of your outdoor products, avoid extended and lengthy exposure to rain, snow, and direct sunshine. Whenever possible cover the product and /or place under patio or awnings.
  -   ● Not for commercial use. For residential use only .
  -   ● Stains may be removed with mild soap solution and damp cloth.
  -   ● Keep away from sources of ignition.
- 
-   ● Dust and pick-up spills using a clean, non-colored, lint-free cloth.