

ASSEMBLY AND INSTALLATION INSTRUCTIONS

WARNING: TO AVOID RISK OF ELECTRICAL SHOCK, BE SURE TO SHUT OFF POWER BEFORE INSTALLING OR SERVICING THIS FIXTURE.

NOTES: 1. Before installing, consult local electrical codes for wiring and grounding requirements.
2. READ AND SAVE THESE INSTRUCTIONS.

Hardware Package (included):

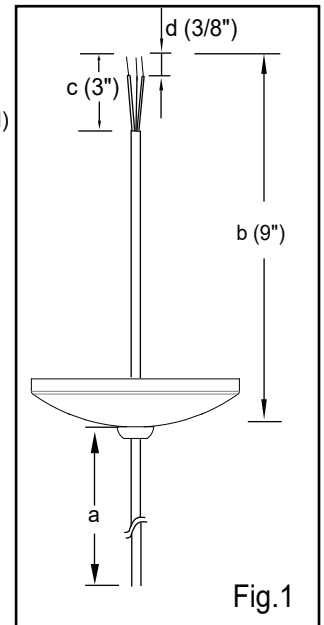
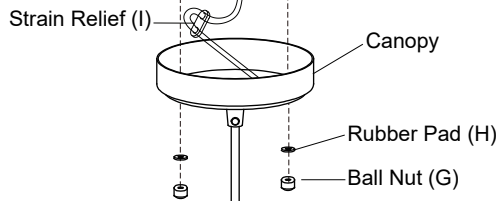
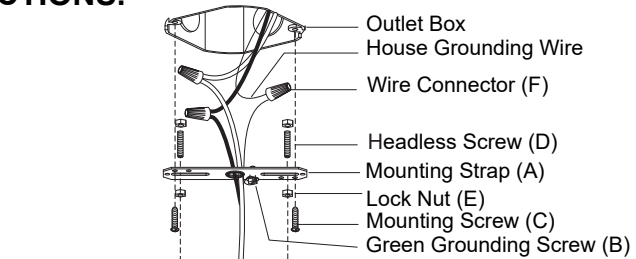
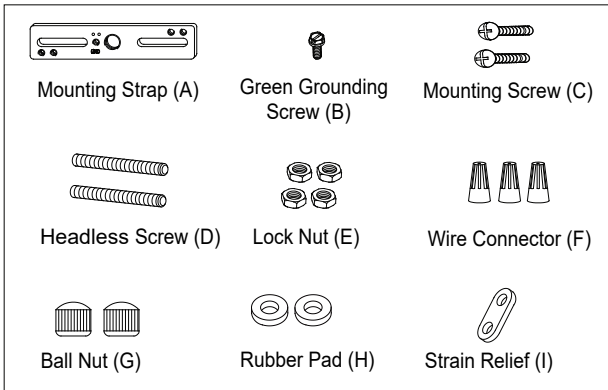

Installation Steps

Turn off the power at fuse or circuit box.

1. Unscrew two ball nuts (G), remove mounting strap (A) from canopy and rubber pads (H).
2. Thread the cord through the canopy and strain relief (I). Measure the desired length of the cord (a) from the canopy to the shade and leave additional 9" cord (b) above the canopy (include the canopy). Then cut off the unnecessary cord. (See Fig. 1)
3. Adjust strain relief (I) at 9" position from the top of the cord.
4. Mark the 3" cord (c) from the top of the cord (b). Use a knife to peel off the insulation of the cord (c) carefully to show the 3 inside wires out. (See Fig. 1)
Caution : Cutting too deep may cut off three inside wires and destroy the insulation surface of the three inside wires.
5. Peel off the 3 wires from the top about 3/8" long (d) to expose the copper for wiring.
6. Attach the mounting strap (A) to outlet box by using two mounting screws (C).
7. Pull out the source wires from the outlet box. Make wire connections using wire connectors (F) as follow:
 - Connect the hot wire (usually black insulation) from the black wire from the power source.
 - Connect the neutral wire (usually white insulation) from the white wire from the power source.
 - Attach the fixture grounding wire (usually green insulation) to the mounting strap (A) with the green grounding screw (B). Then to the house grounding wire with the wire connector (F). Carefully put the wires back into the outlet box.

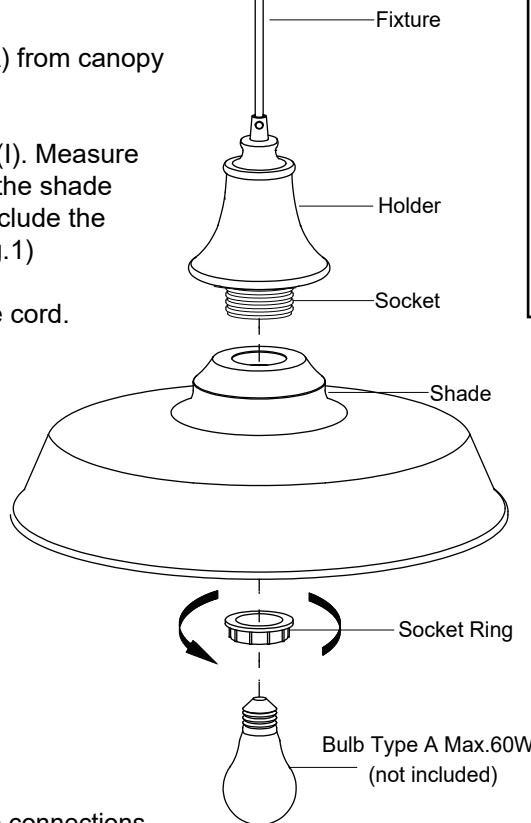

8. Pull the cord (a) down slightly until the strain relief (l) touches the hex nut. Attach the canopy to the mounting strap (A) by inserting two headless screws (D), adjust the length of the headless screw (D) if necessary. then secure it with two rubber pads (H) and two ball nuts (G).

Note: Adjust the strain relief can decrease or increase the length of cord exposing outside.









9. Attach shade to socket, then secure it with socket ring.

10. Install bulb(not included). See relamping label at socket area or packaging for maximum allowed wattage.

Turn on the power at fuse or circuit box.

The following parts are available for re-order if damaged or missing.

Spare Parts List:

 Mounting Strap (A)	 Green Grounding Screw (B)	 Mounting Screw (C)	 Headless Screw (D)	
 Lock Nut (E)	 Wire Connector (F)	 Ball Nut (G)	 Rubber Pad (H)	 Strain Relief(I)

Assembly Kit (1 SET)

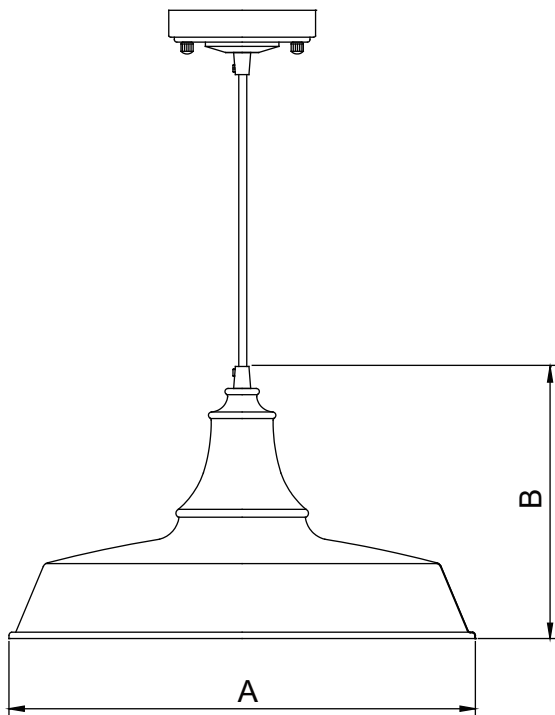

A: 15"

B: 8.5"