

Queen Bed

Assembly Instructions - Please keep for future reference

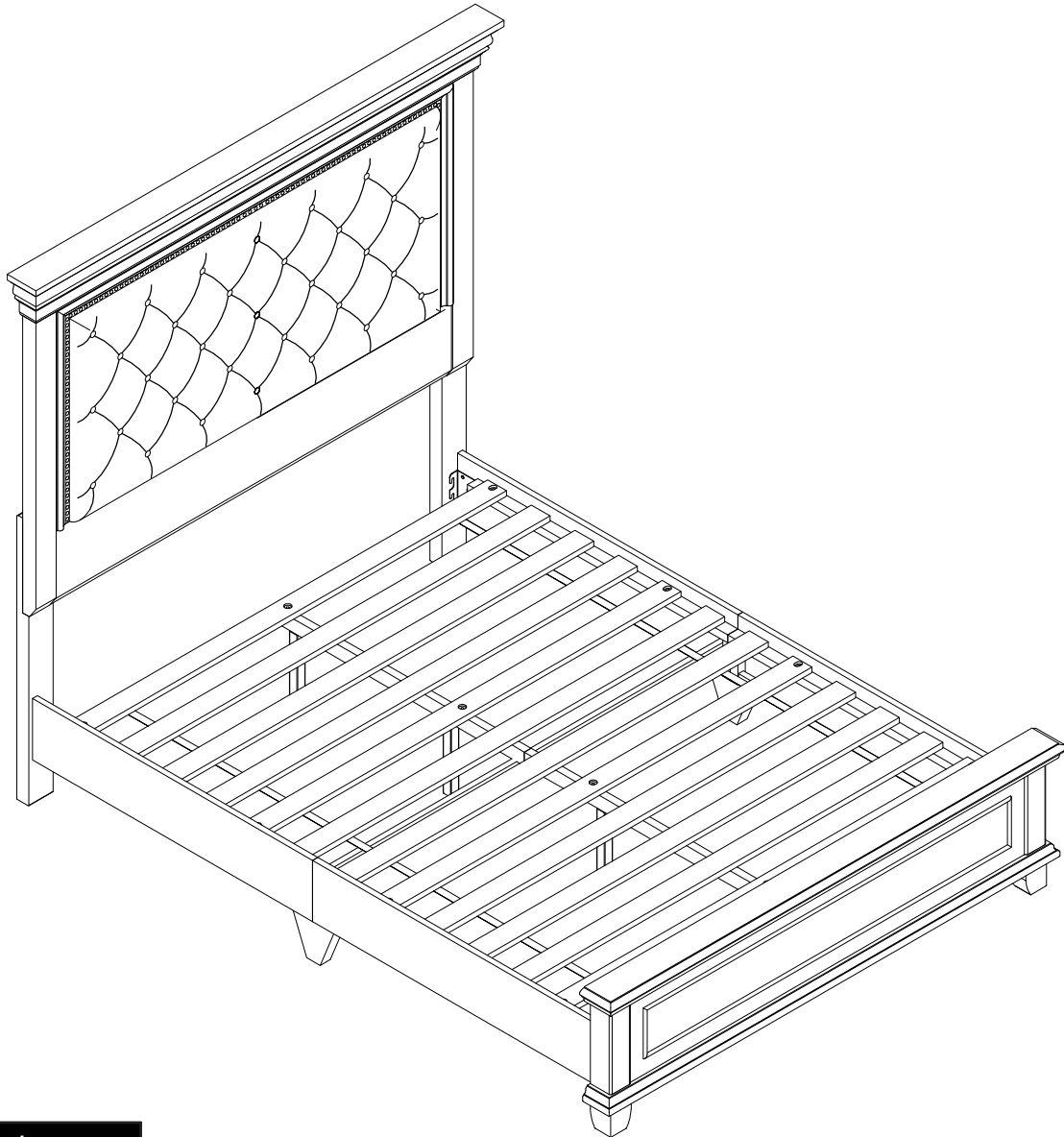

Dimensions

Width - 88.4inch
Depth - 68.5inch
Height - 68inch

Any question please feel free to contact us:
support@amer-life.com TEL: (901) 347-2181
We will provide further assistance within 24 hours.

Important – Please read these instructions fully before starting assembly

Seller's Notice:

Our product is packed in separate boxes as shown below, and they might be shipped in different batches. Please wait until you received all the boxes then start the assembly.





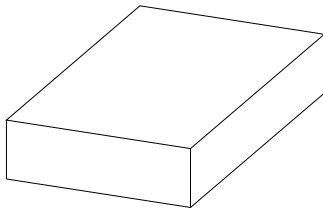

Noted: Assembly instruction is only provided in Box1.

The following is the list of components contained in each box.

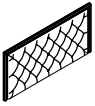
BOX 1





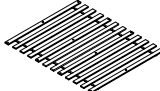



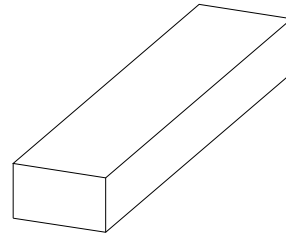



Main structure accessories

2		UPH HB Panel	x1
3		Stretcher HB	x1
6		Left post	x1
7		Right post	x1
8		Backside's connecting bar 1	x2
10		Footboard	x1
16		Siderails's connecting bar	x1
17		Slats	x1

BOX 2

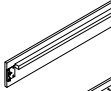
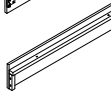

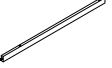
Main structure accessories

1		Top bar HB	x1
4		HB left bar	x1
5		HB right bar	x1
9		Backside's connecting bar 2	x2
11		FB left leg	x1
12		FB right leg	x1
13		Siderails 1	x2
14		siderails 2	x2
15		siderails support leg	x2
18		Center support 1	x1
19		Center support 2	x1
20		Center support leg	x4

All hardware are in Box 2.



Safety and Care Advice

Important – Please read these instructions fully before starting assembly

- Check you have all the components and tools listed on the following pages.
- Remove all fittings from the plastic bags and separate them into their groups.
- Keep children and animals away from the work area, small parts could choke if swallowed.
- Make sure you have enough space to layout the parts before starting.

- During assembly do not stand or put weight on the product, this could cause damage.
- Assemble the item as close to its final position (in the same room) as possible.
- Assemble on a soft level surface to avoid damaging the unit or your floor.
- Parts of the assembly will be easier with 2 people.



- To reduce the likelihood of damaging your product please ensure that your power drill is set on a low torque setting.

Care and maintenance

- Only clean using a damp cloth and mild detergent, do not use bleach or abrasive cleaners.
- From time to time check that there are no loose screws on this unit.
- This product should not be discarded with household waste. Take to your local authority waste disposal centre.

Handy Hints

- Assemble all parts and bolts loosely during assembly, only once the product is complete should you fully tighten the bolts
- Regularly check and ensure That all bolts and fittings are tightend properly.

WARNING

In order to help prevent overturning – please follow these instructions

To help prevent product toppling over please follow the below steps:-

Use the anti tip stap or wall fixing method provided (if applicable)
Do not allow children to climb or hang on the furniture
Do not open more than one drawer at a time
Do not place heavy items in the top drawers
Do not place heavy items on top of the furniture, unless the furniture has been designed for this purpose

please note that only the anti tip strap is provided.
You will need to provide wall plugs and screws applicable for your wall type

Components - Panels

Please check you have all the panels listed below

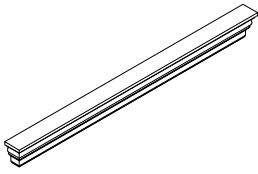

1 (1739x159x106mm) x 1

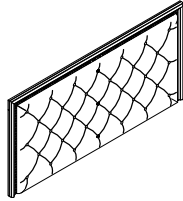

2 (1473x708x59mm) x 1

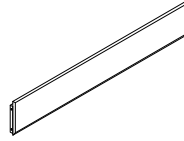

3 (1473x250x40mm) x 1



4 (959x76x49mm) x 1



5 (959x76x49mm) x 1

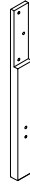

6 (915x90x45mm) x 1



7 (915x50x45mm) x 1

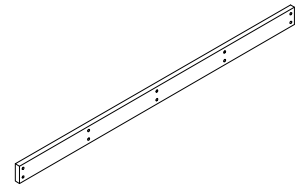

8 (1473x80x22mm) x 2

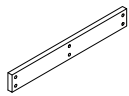

9 (614x80x22mm) x 2

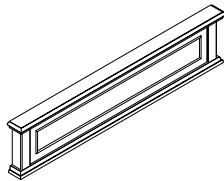

10 (1699x368x116mm) x 1



11 (92x76x76mm) x 1



12 (92x76x76mm) x 1

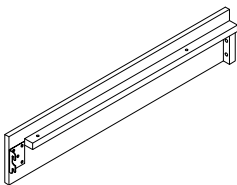

13 (1041.5x197x57mm) x 2

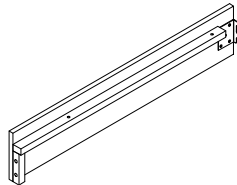

14 (1041.5x197x57mm) x 2

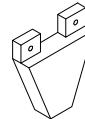

15 (167x153x38mm) x 2

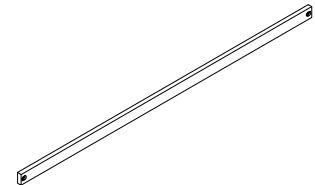

16 (1555x50x15mm) x 1

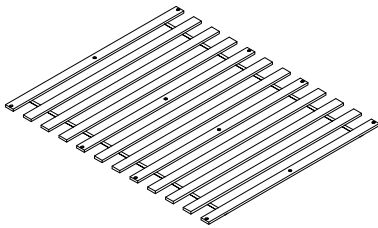

17 (1555x50x15mm) x 12

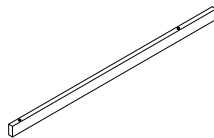

18 (926.5x45x25mm) x 1

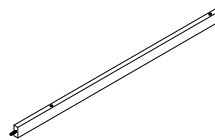

19 (926.5x45x25mm) x 1

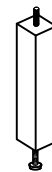











20 (235x30x30mm) x 4

Components - Fittings

Please check you have all the hardware listed below

Note: The quantities below are the correct amount to complete the assembly. In some cases more fittings may be supplied than are required.

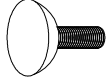
A  10x40mm Dowel x 4	B  1/4"x32mm Bolt x 18	C  1/4"x10x2mm Spring Washer x 18
D  1/4"x19x2mm Flat Washer x 18	E  5/16"x20mm Bolt x 8	F  5/16"x35mm Bolt x 36
G  5/16"x45mm Bolt x 10	H  5/16"x55mm Bolt x 2	I  5/16"x12x2mm Spring Washer x 56
J  5/16"x19x2mm Flat Washer x 56	K  4mm Allen Wrench x 1	L  M8x38mm Retainer x 2

Tools required

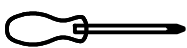

Phillips screwdriver
(medium & large)

Ruler - Use this ruler to help correctly identify the screws

0 5 10 15 20 25 30 35 40 45 50 55 60 65 70 75 80 85 90 95 100 105 110 115 120 125 130 135 140 145 150 155 160 165 170

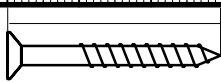

The screws length is measured from the head to the point (30mm screw shown).



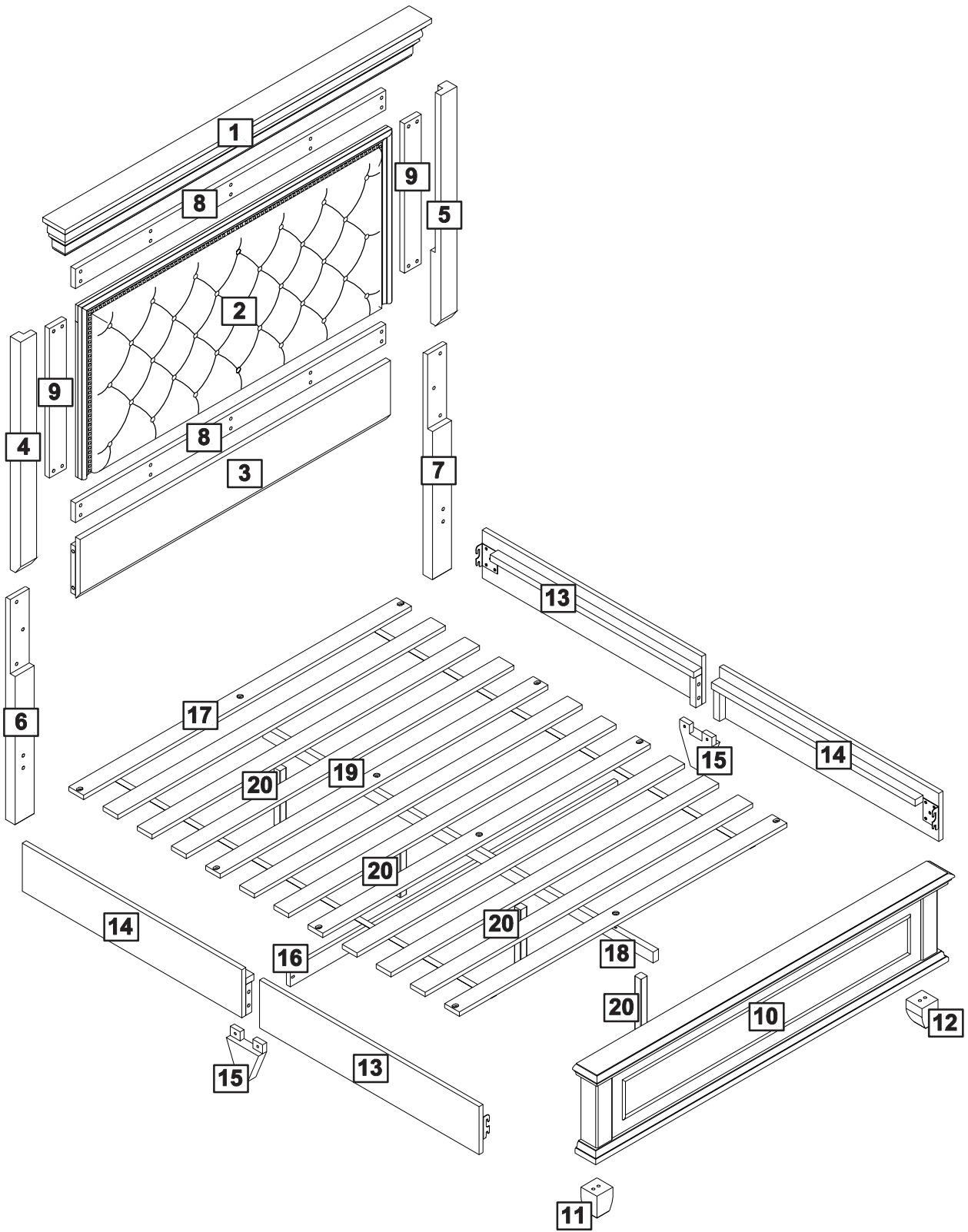

Assembly Instructions

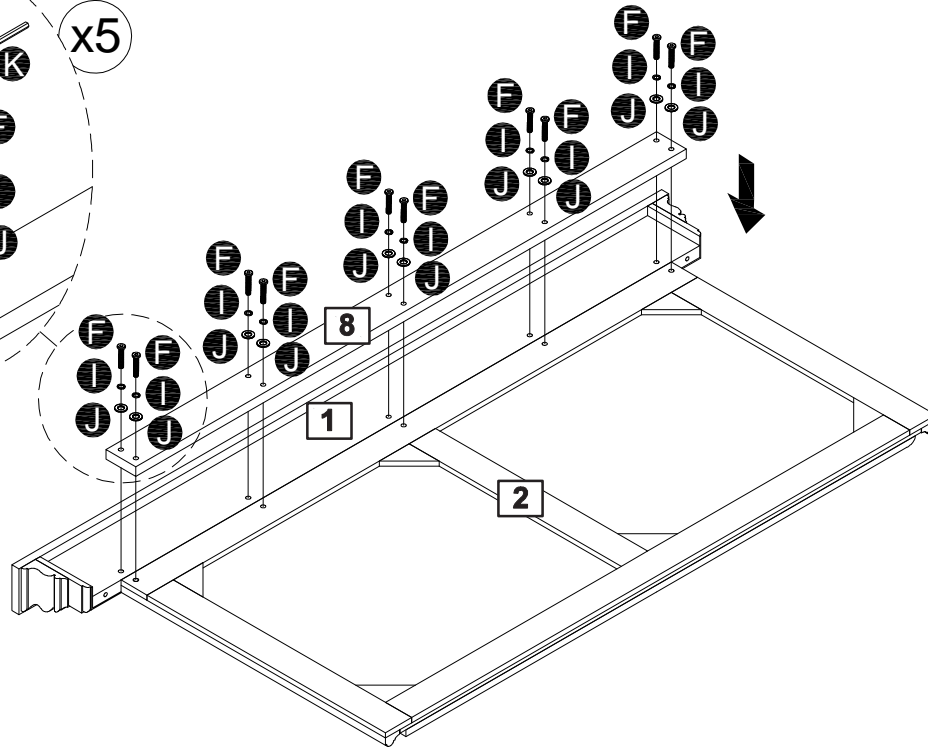
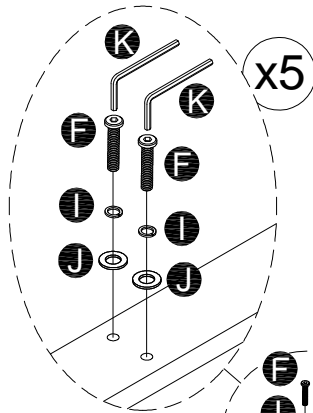

Assembly Instructions

Step 1



-  **F** x 10
5/16"x35mm Bolt
-  **L** x 10
5/16"x12x2mm Spring Washer
-  **J** x 10
5/16"x19x2mm Flat Washer
-  **K** x 1
4mm Allen Wrench

Step 2

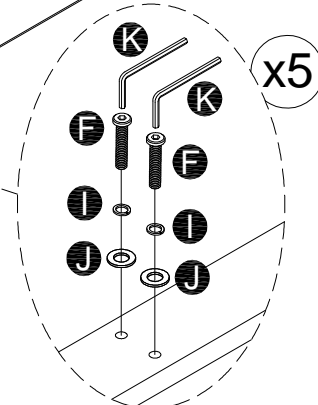
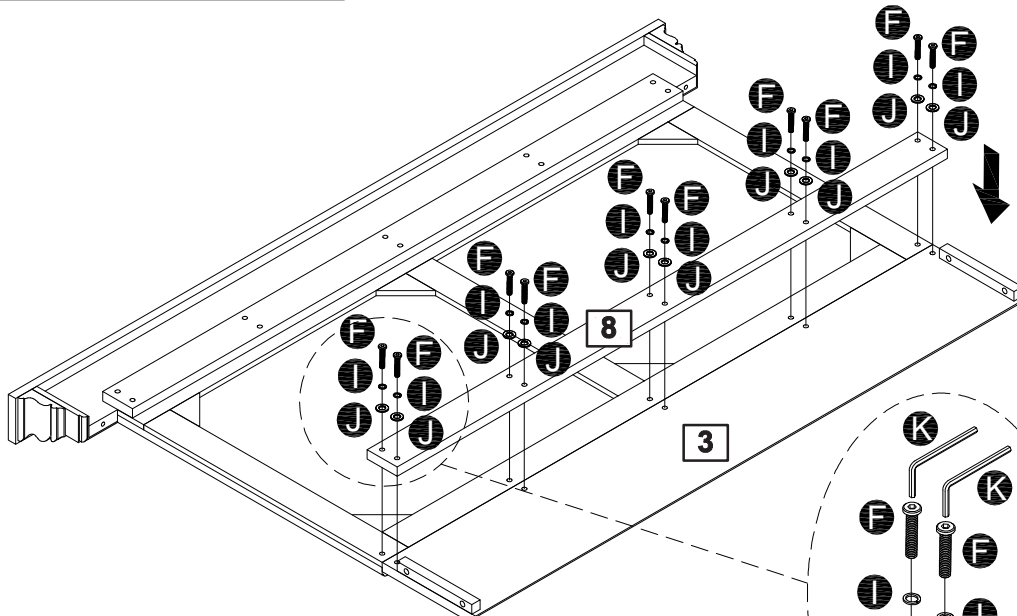

-  **F** x 10
5/16"x35mm Bolt
-  **L** x 10
5/16"x12x2mm Spring Washer
-  **J** x 10
5/16"x19x2mm Flat Washer
-  **K** x 1
4mm Allen Wrench

Assembly Instructions

Step 3

A 
A x 2
10x40mm Dowel

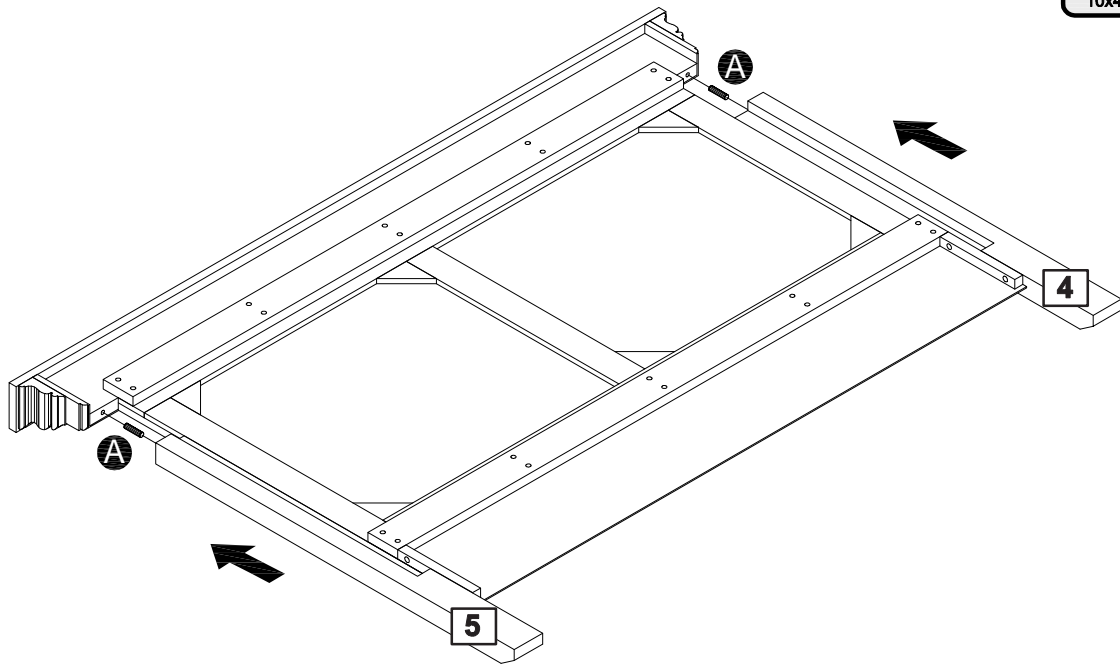

Step 4

F 
F x 16
5/16"x35mm Bolt

I 
I x 16
5/16"x12x2mm Spring Washer

J 
J x 16
5/16"x18x2mm Flat Washer

K 
K x 1
4mm Allen Wrench

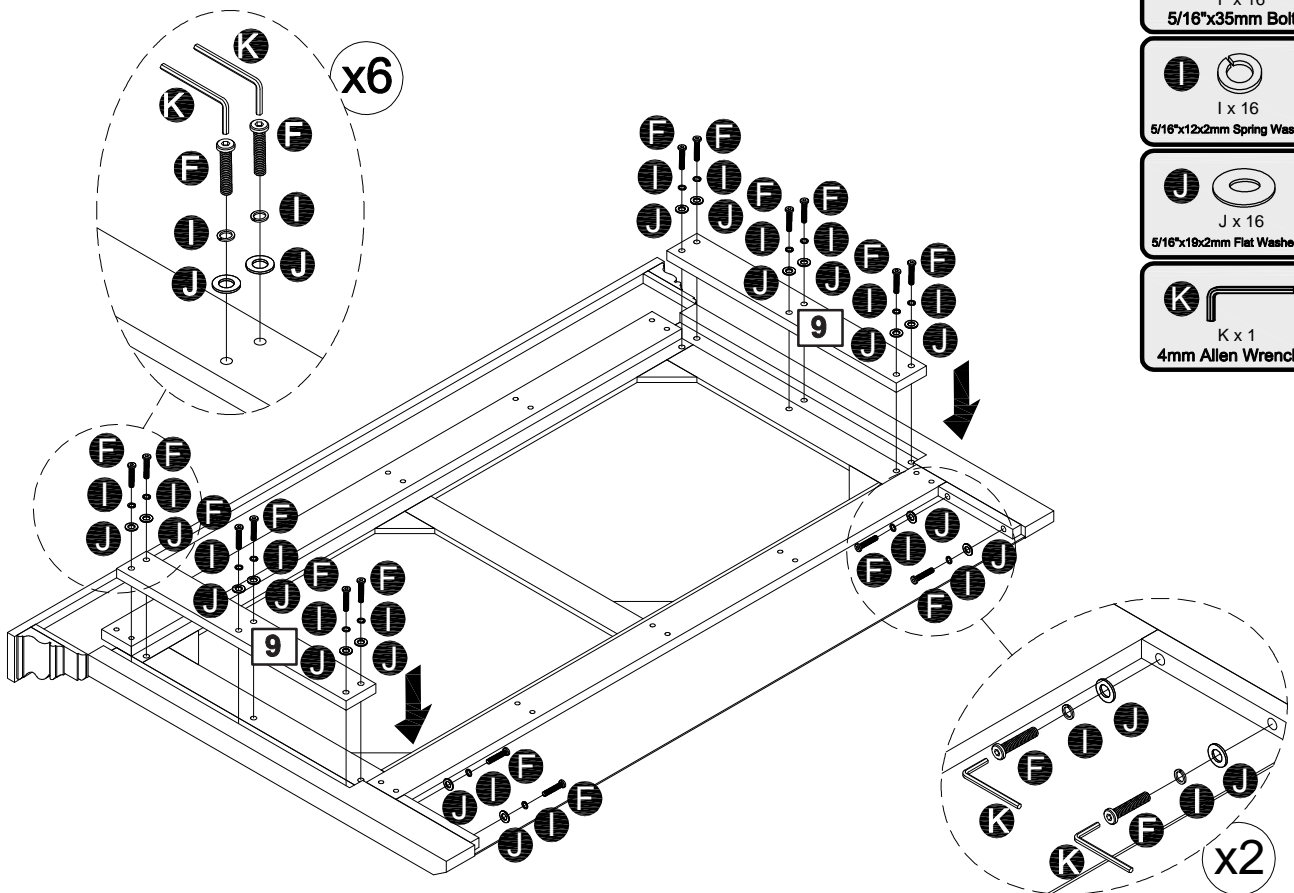

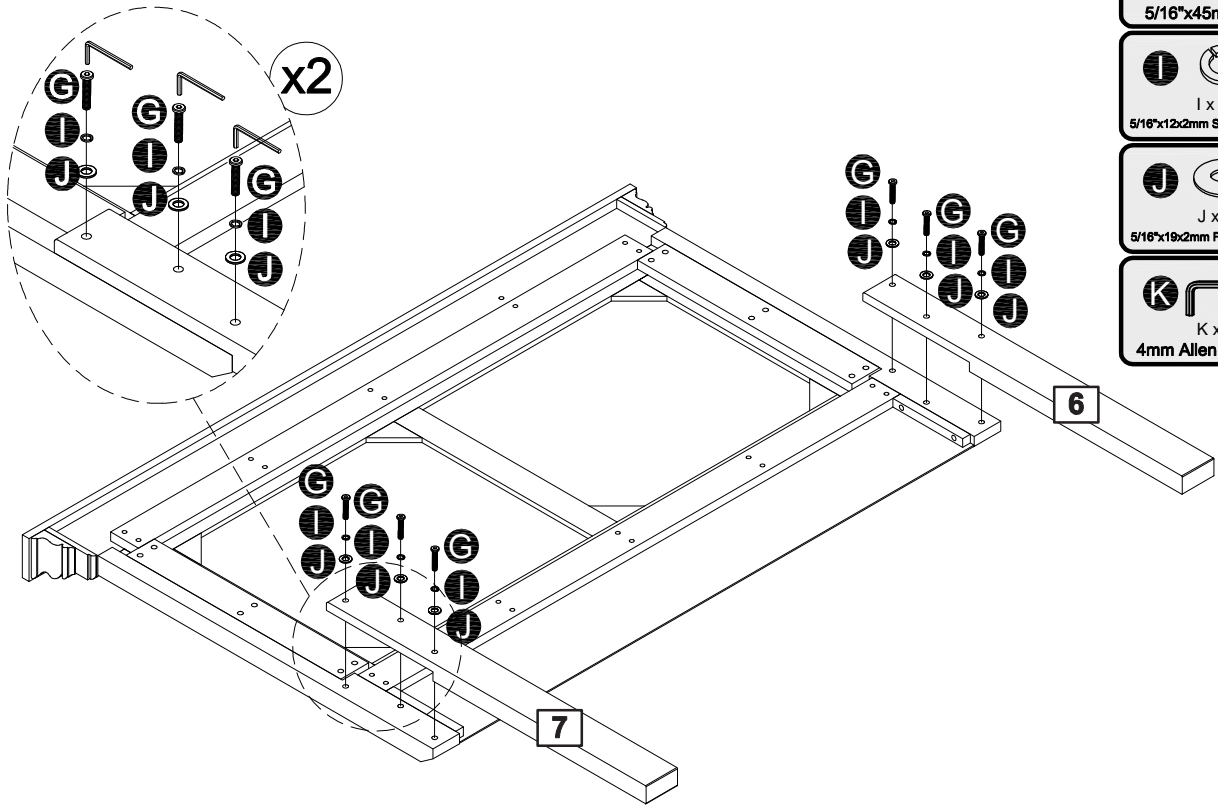

Assembly Instructions

Step 5



- 

G x 6
5/16"x45mm Bolt
- 

I x 6
5/16"x12x2mm Spring Washer
- 

J x 6
5/16"x19x2mm Flat Washer
- 

K x 1
4mm Allen Wrench

Step 6

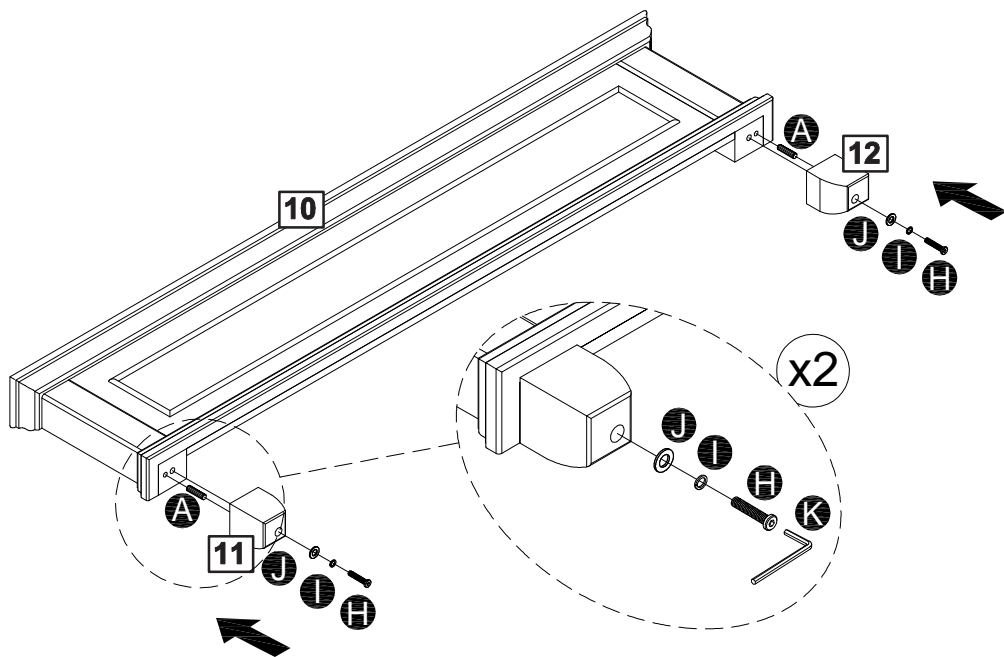

- 

A x 2
10x40mm Dowel
- 

H x 2
5/16"x55mm Bolt
- 

I x 2
5/16"x12x2mm Spring Washer
- 

J x 2
5/16"x19x2mm Flat Washer
- 

K x 1
4mm Allen Wrench

Assembly Instructions

Step 7

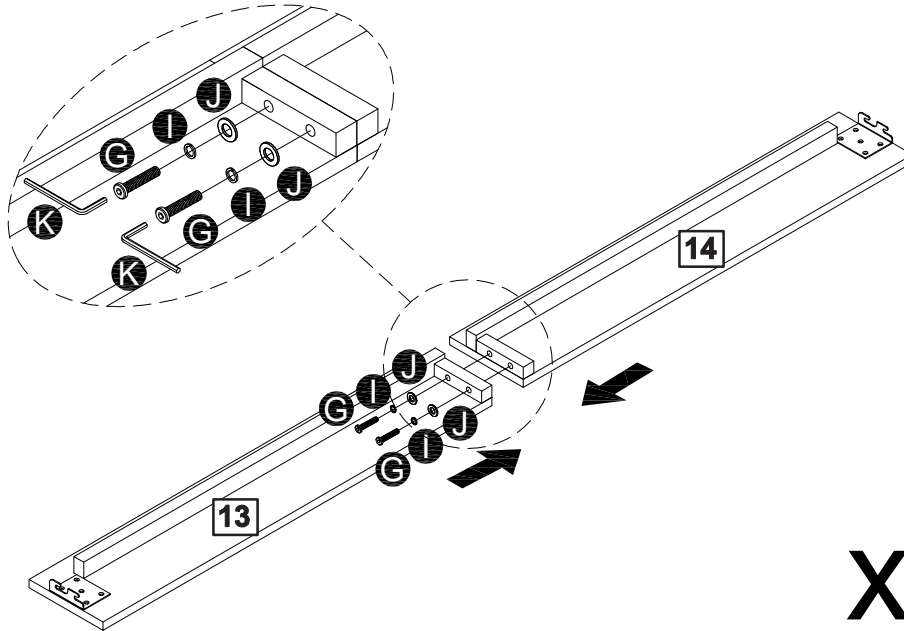



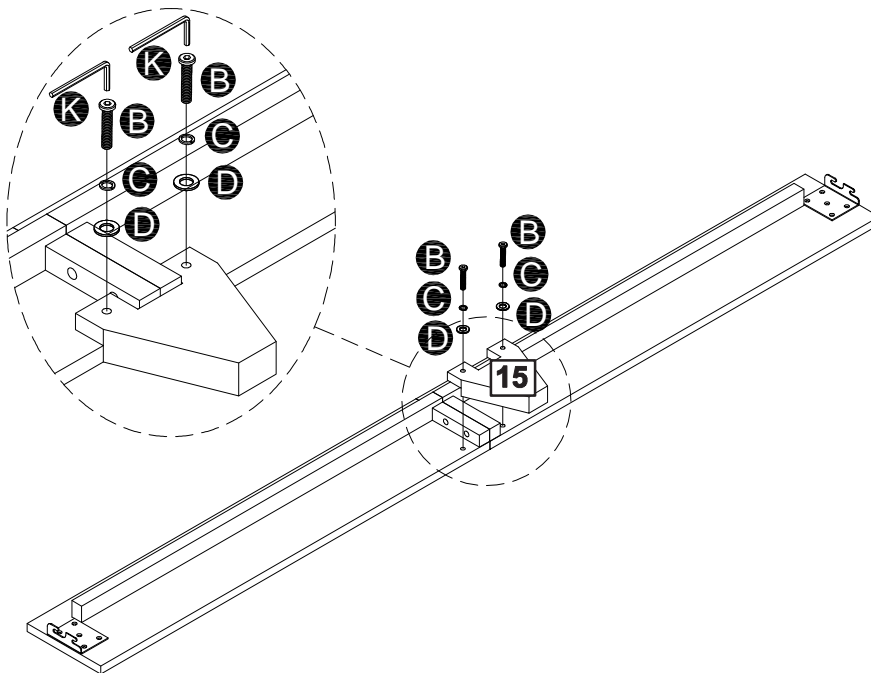

- G**  $G \times 4$
5/16"x45mm Bolt
- I**  $I \times 4$
5/16"x12x2mm Spring Washer
- J**  $J \times 4$
5/16"x19x2mm Flat Washer
- K**  $K \times 1$
4mm Allen Wrench

x2

Step 8



- B**  $B \times 4$
1/4"x32mm Bolt
- C**  $C \times 4$
1/4"x10x2mm Spring Washer
- D**  $D \times 4$
1/4"x19x2mm Flat Washer
- K**  $K \times 1$
4mm Allen Wrench

x2

Assembly Instructions

Step 9

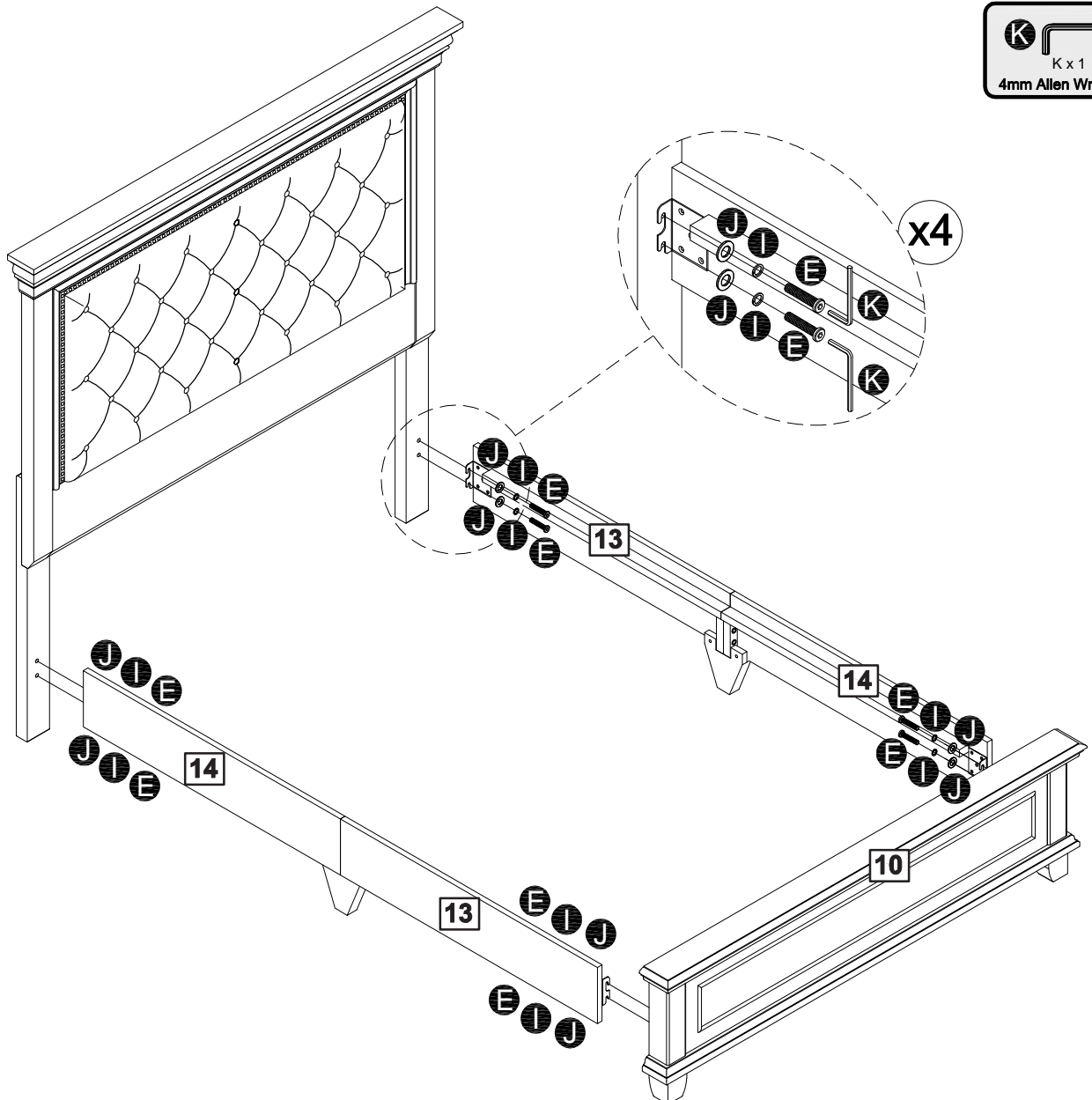

Assembly Instructions

Step 10



B x 2
1/4"x32mm Bolt



C x 2
1/4"x10x2mm Spring Washer



D x 2
1/4"x18x2mm Flat Washer



K x 1
4mm Allen Wrench

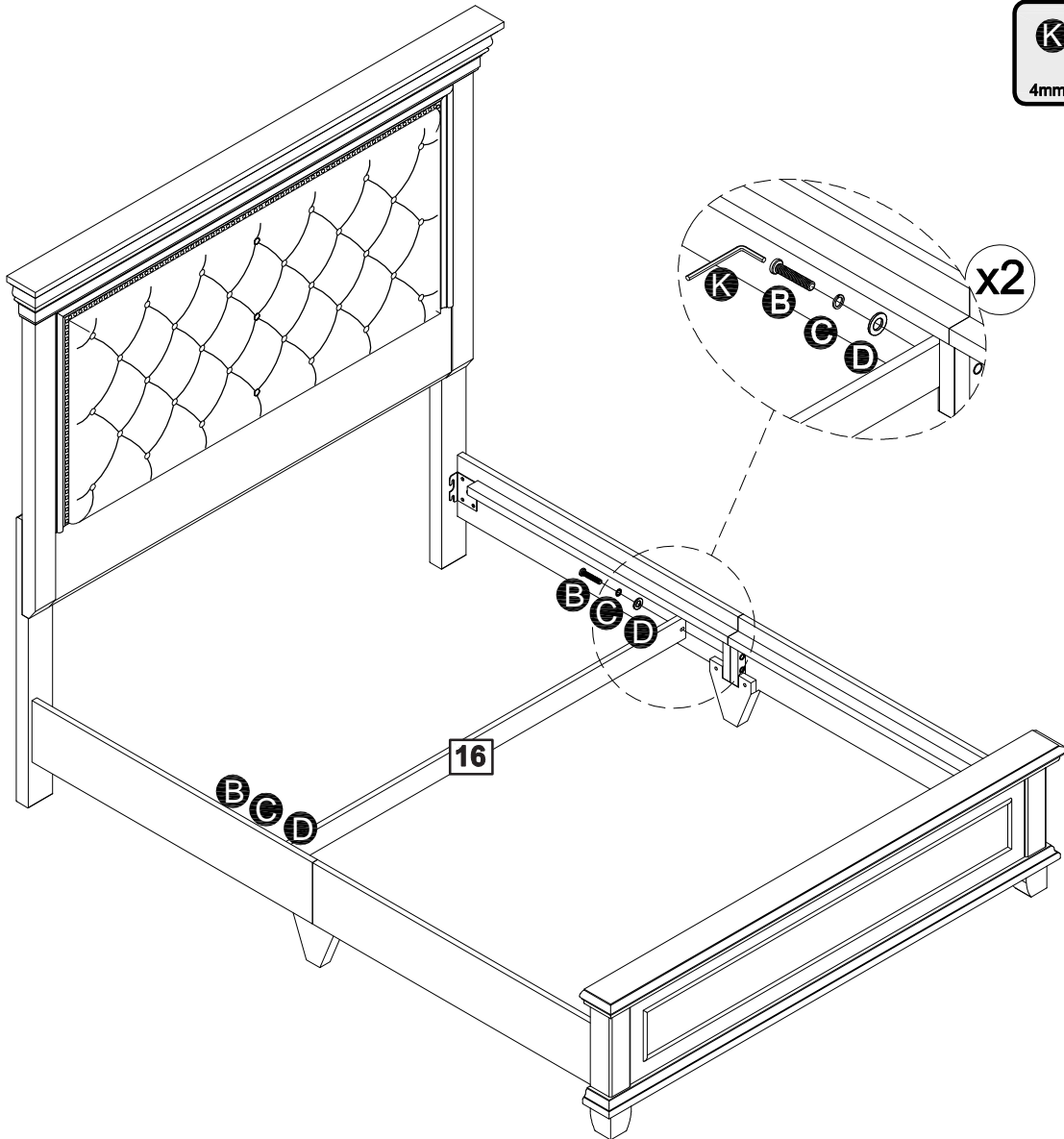

Assembly Instructions

Step 11

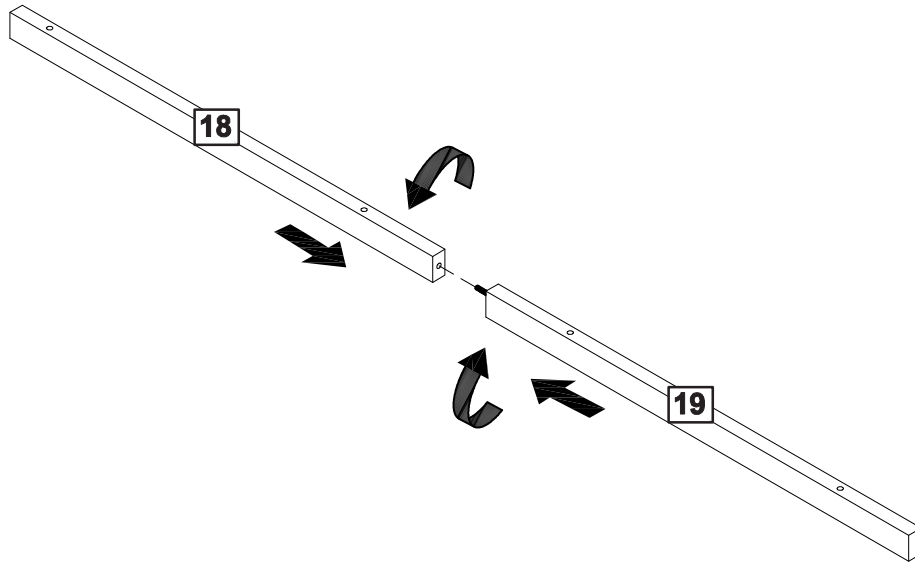

Step 12

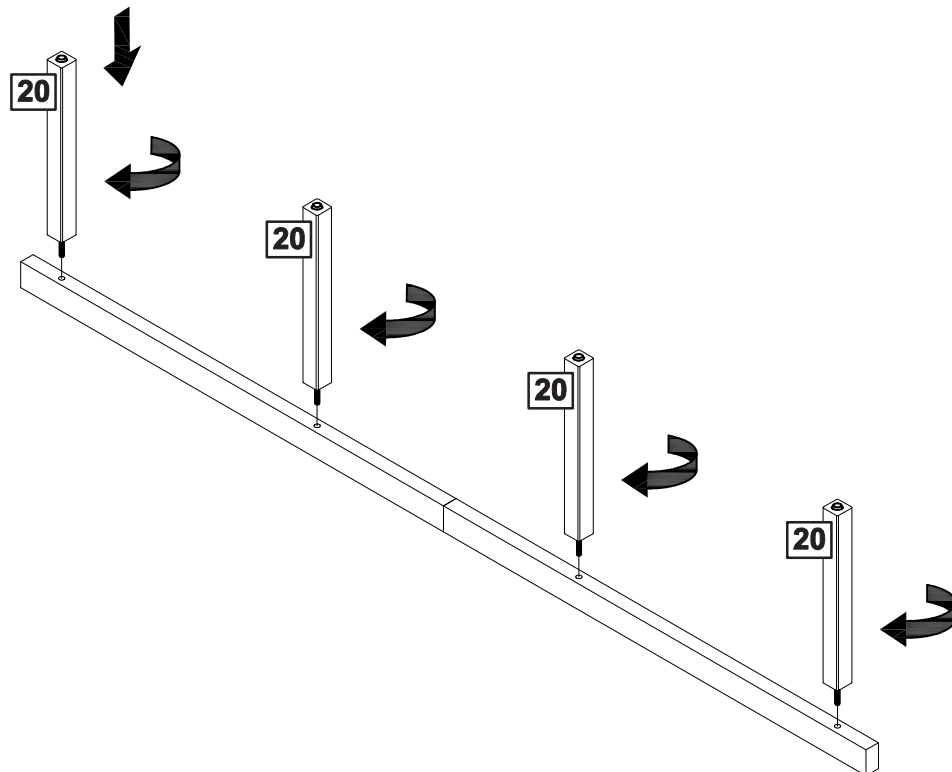

Assembly Instructions

Step 13

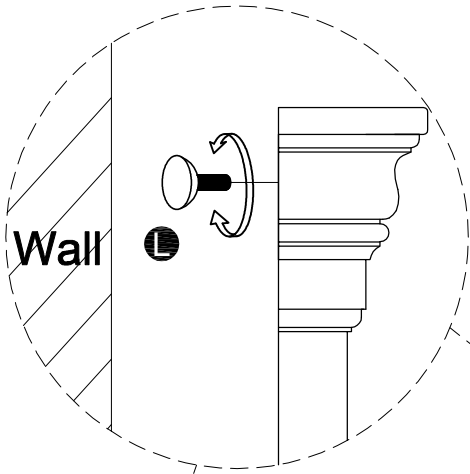

- B**  B x 12
1/4"x32mm Bolt
- C**  C x 12
1/4"x10x2mm Spring Washer
- D**  D x 12
1/4"x18x2mm Flat Washer
- K**  K x 1
4mm Allen Wrench
- L**  L x 2
M8x38mm Retainer

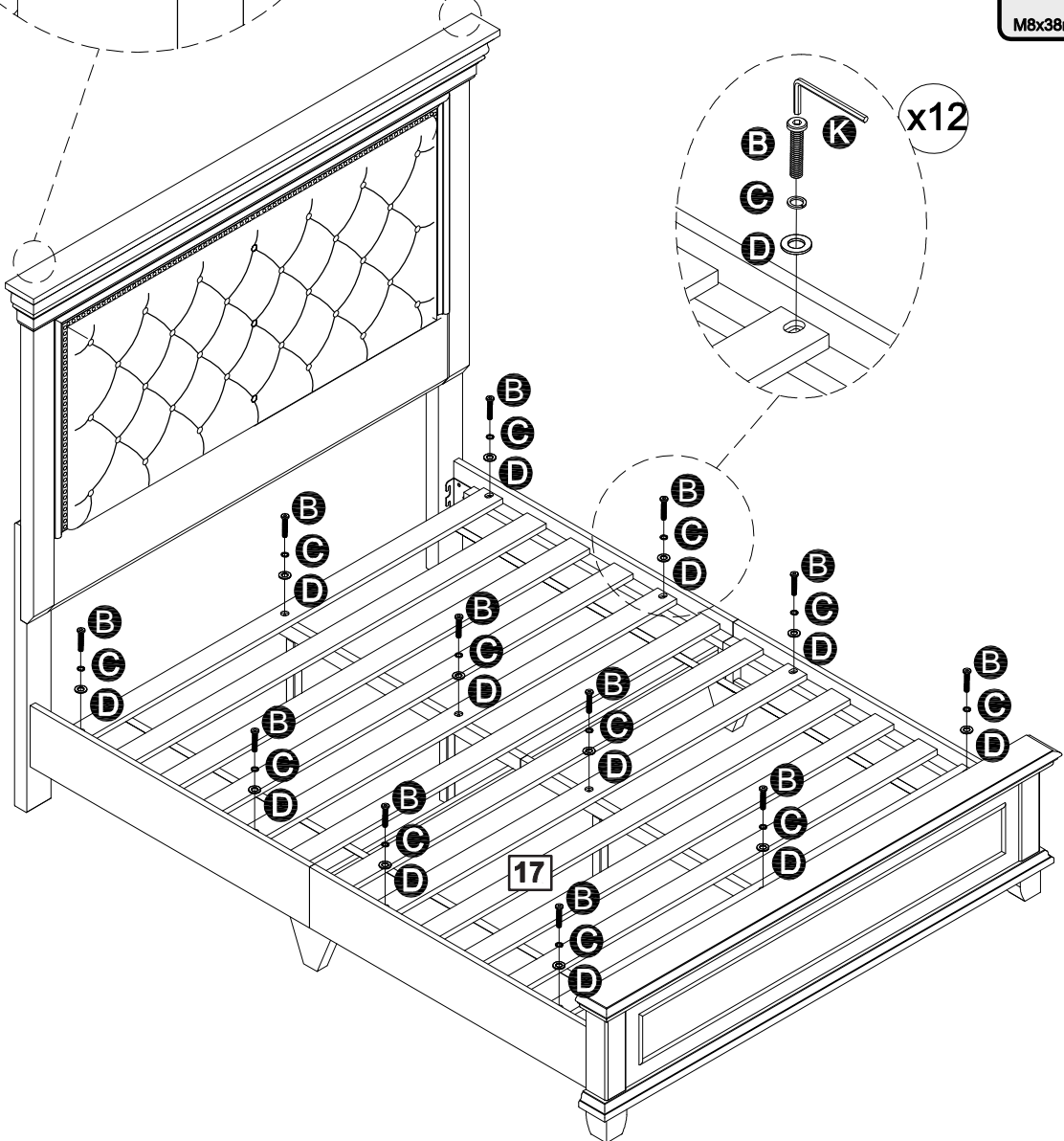
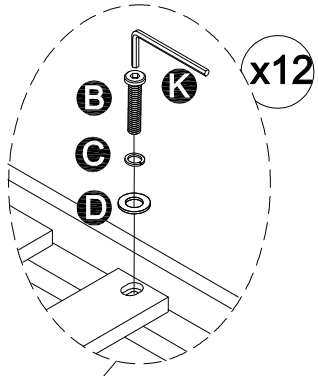

Assembly Instructions

Step 14

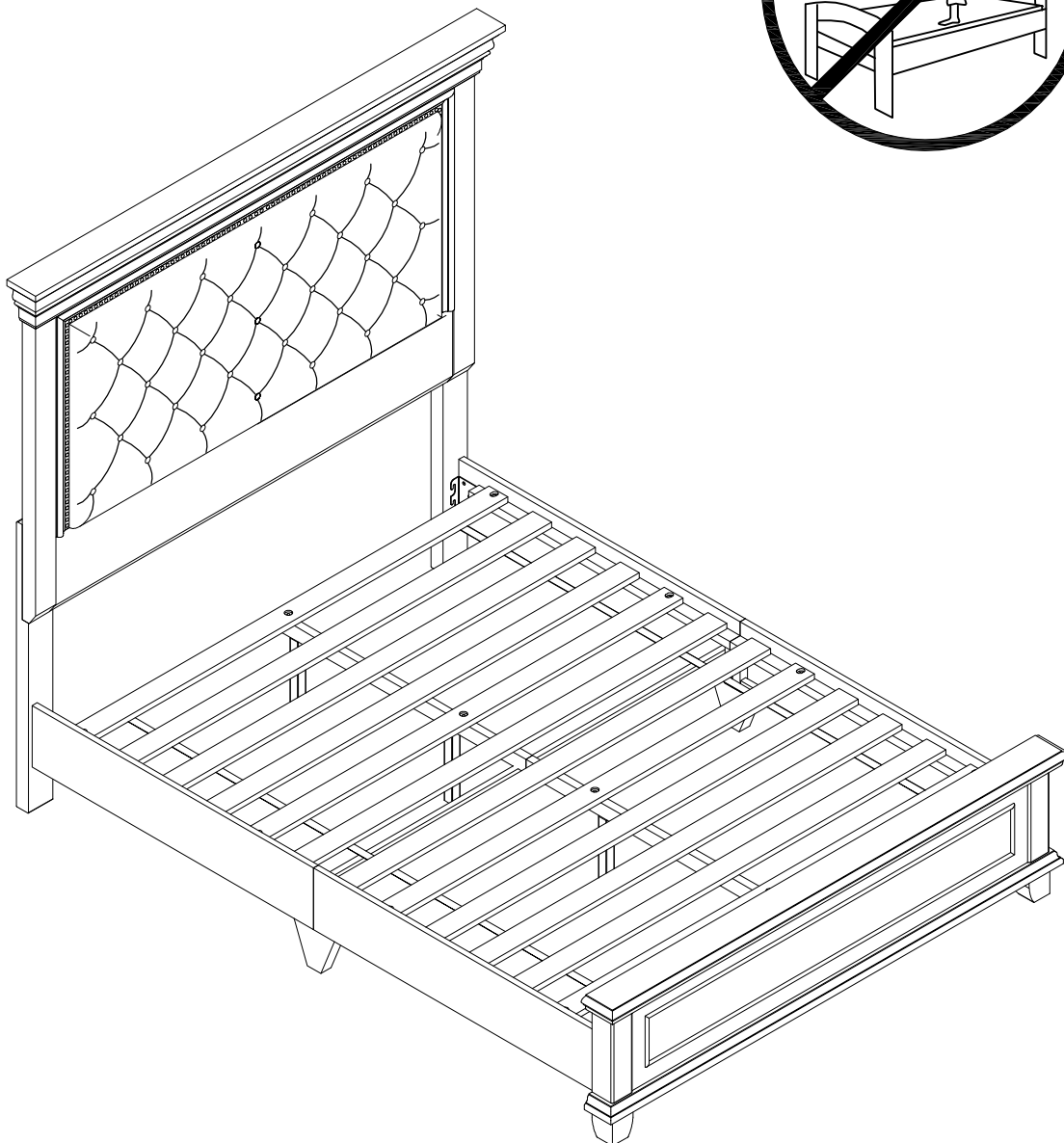

Installation Complete.