

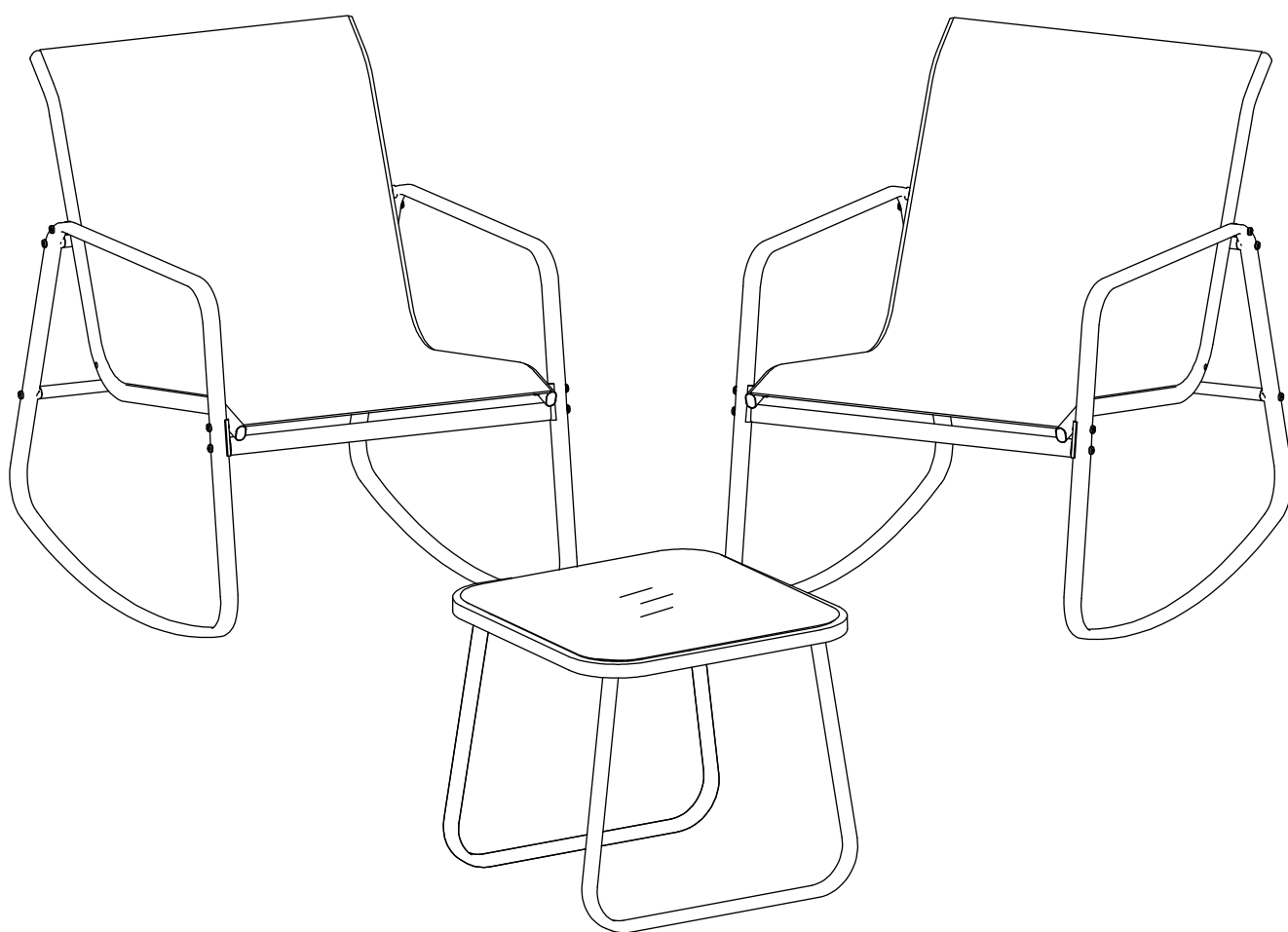







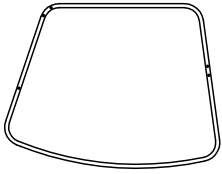
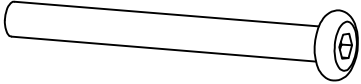
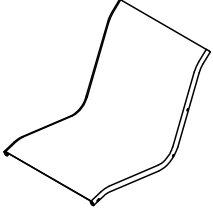
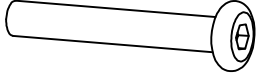
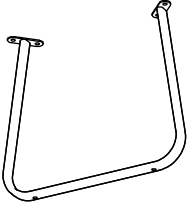
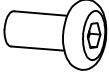
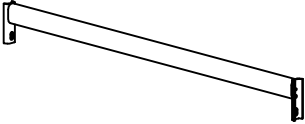

Instruction of Patio Chair Set

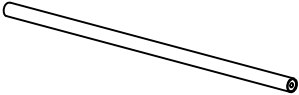
SKU:OV-RS061

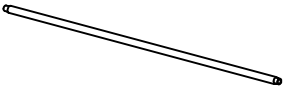

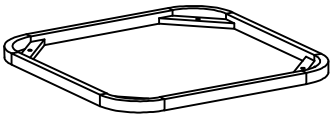
Warning : Please tighten all screws after installation.

PACKING LIST

| | | | | | |
|---|---|---|---|----|---|
| A | 4 |  | J | 8 |  |
| B | 2 |  | K | 12 |  |
| C | 2 |  | L | 8 |  |
| D | 2 |  | M | 8 |  |
| E | 4 |  | N | 28 |  |
| F | 2 |  | O | 12 |  |
| G | 1 |  | P | 1 |  |
| H | 1 |  | Q | 1 |  |

INSTALL THE CHAIR

①

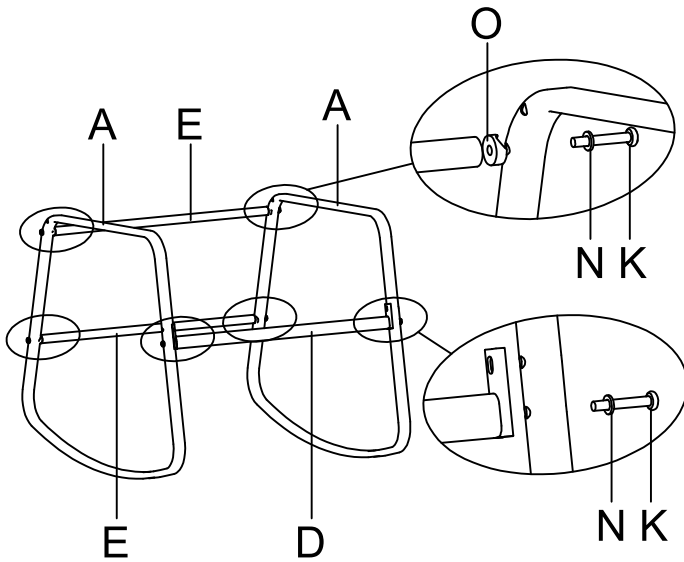

Take out two armrests, then connect the left and right armrest with D&E part, then fix them with N&K as the pics shows.

②

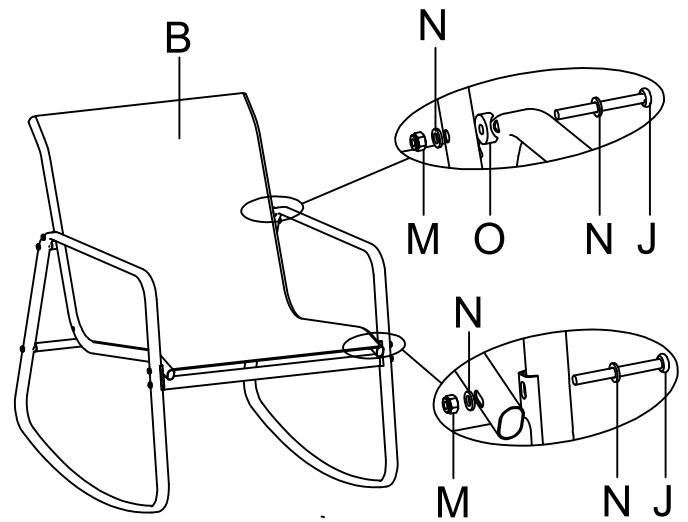

Put the Part B on the Installed chair base, fix the Part B with the screws as pics show.

③

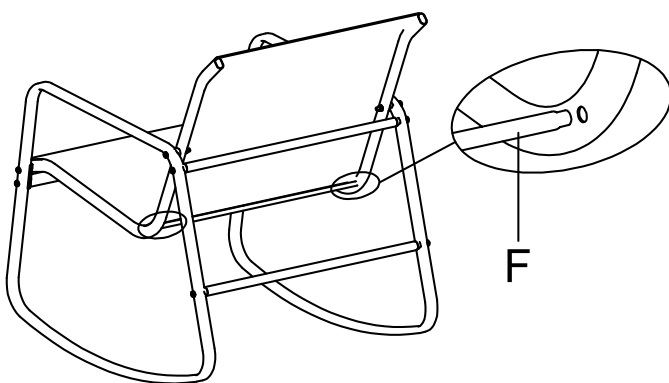

Put the tube F behind the back of the chair.

④

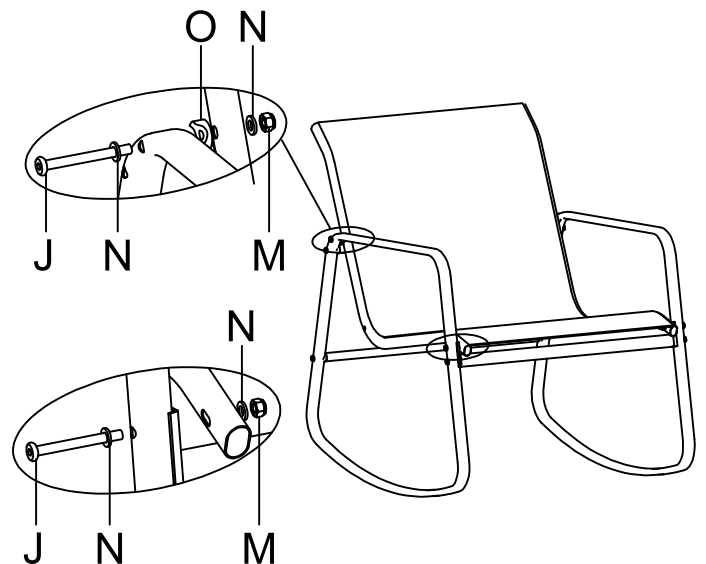

Finally, fix with screws J&M&N as the pics show, then chair is installed.

To install the second chair, you need to repeat the step 1 to 4.

INSTALL THE COFFEE TABLE

①

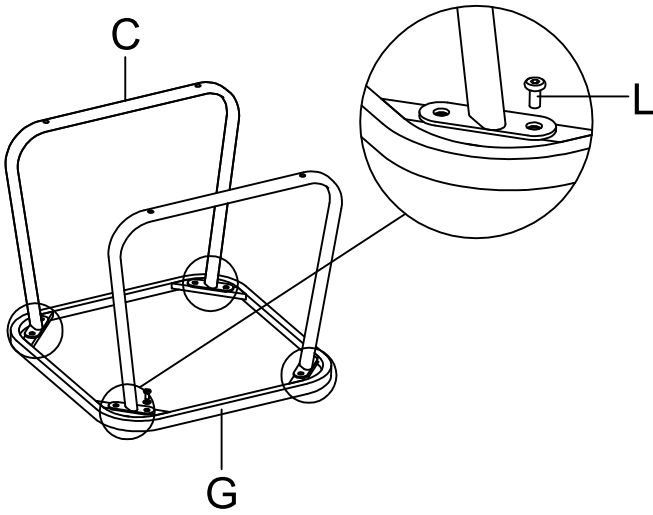

Put the parts C to the G then fix with Screw L.

②

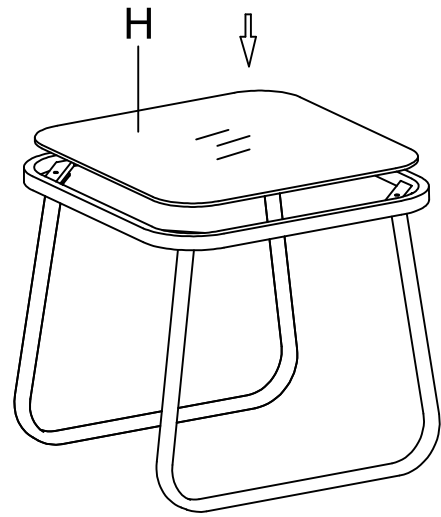

Put the H on the top of the table frame.

Customer Service

Contact email: service-outdoor@hotmail.com