

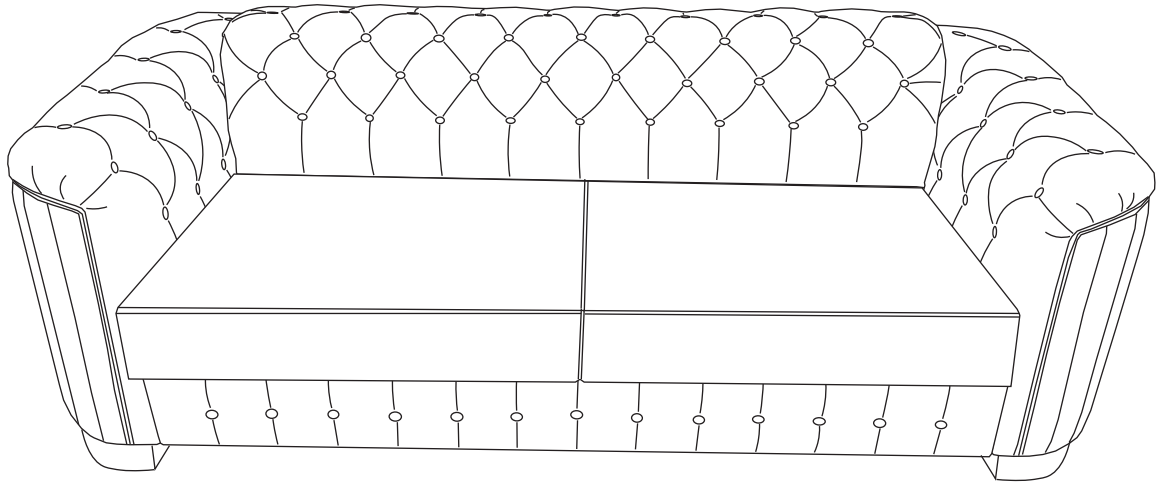

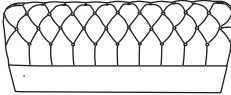

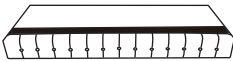

YAL-303-SOFA

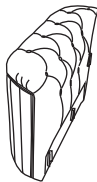

SOFA is packed in 3 cases

Carton	Disignation	Part		Hardware
S1	Backrest	#1		
S2	Seat frame	#2		#A #B #C #D #E
	Cushion	#3		
	Leg	#4		
	Support leg	#5		
ARM	Left arm	#6		
	Right arm	#7		

ASSEMBLY INSTRUCTIONS

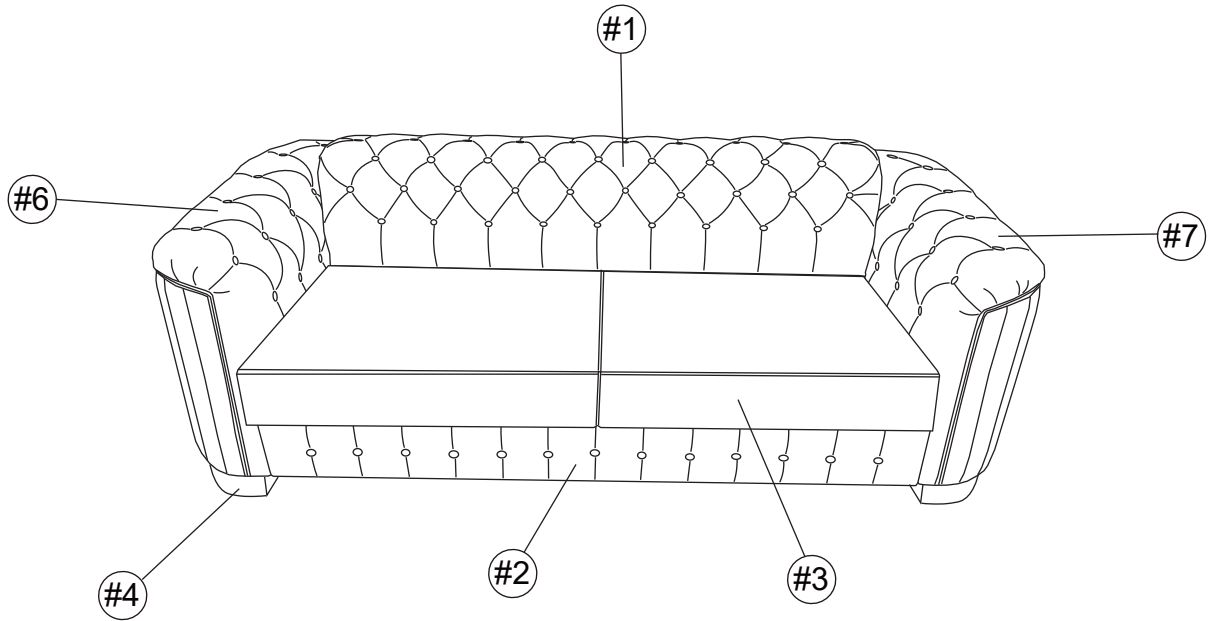

PARTS

#1 1 pc

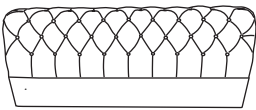

Backrest

#2 1 pc

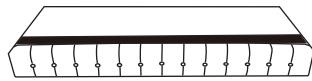

Seat frame

#3 2 pcs



Cushion

#4 4 pcs



Leg

#5 1 pc

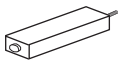

Support leg
30*30*85MM

#6 1 pc

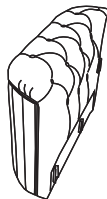

Left arm

#7 1 pc



Right arm

HARDWARE

#A 4 pcs



BOLT 2-1/2 "L

#B 1 pc



ALLEN KEY 100mm L

#C 4 pcs



FLAT WASHER 16mm

#D 4 pcs



SPRING WASHER

#E 8 pcs



Screw 60mm L

ASSEMBLY INSTRUCTIONS

STEP 1:

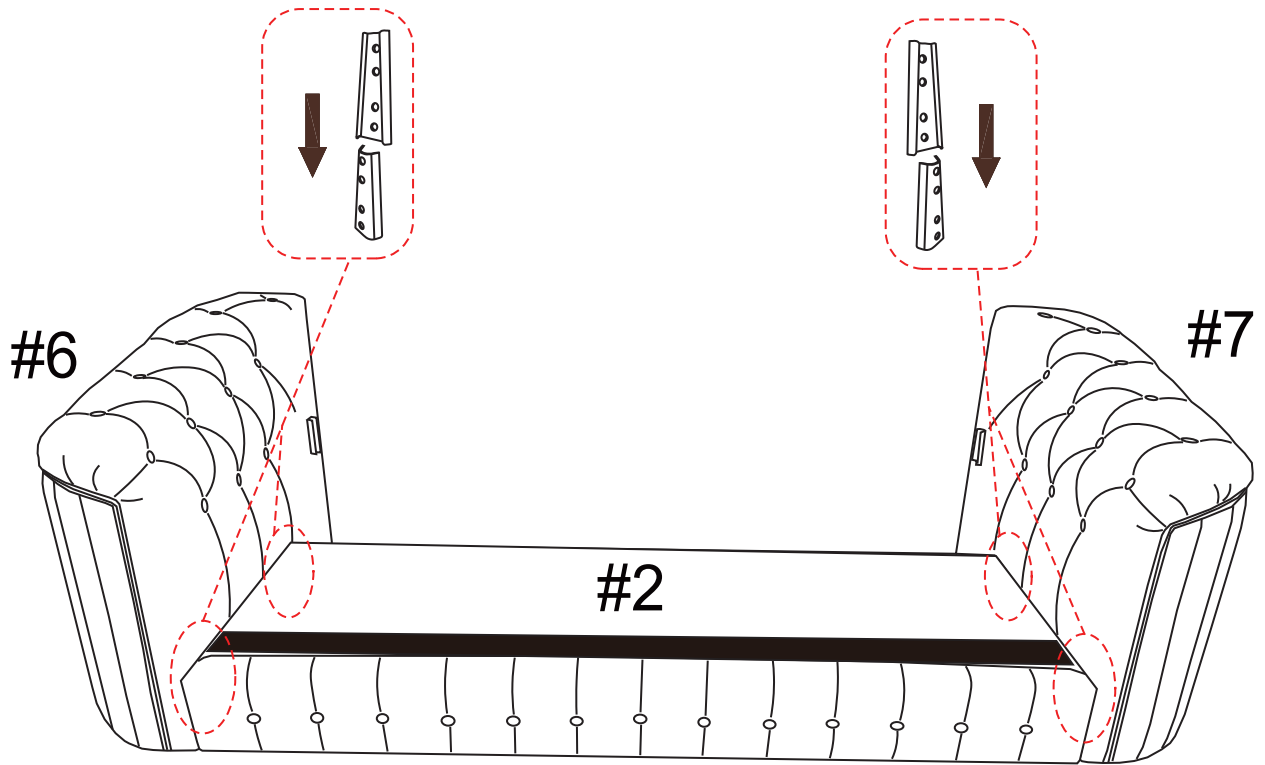

STEP 2:

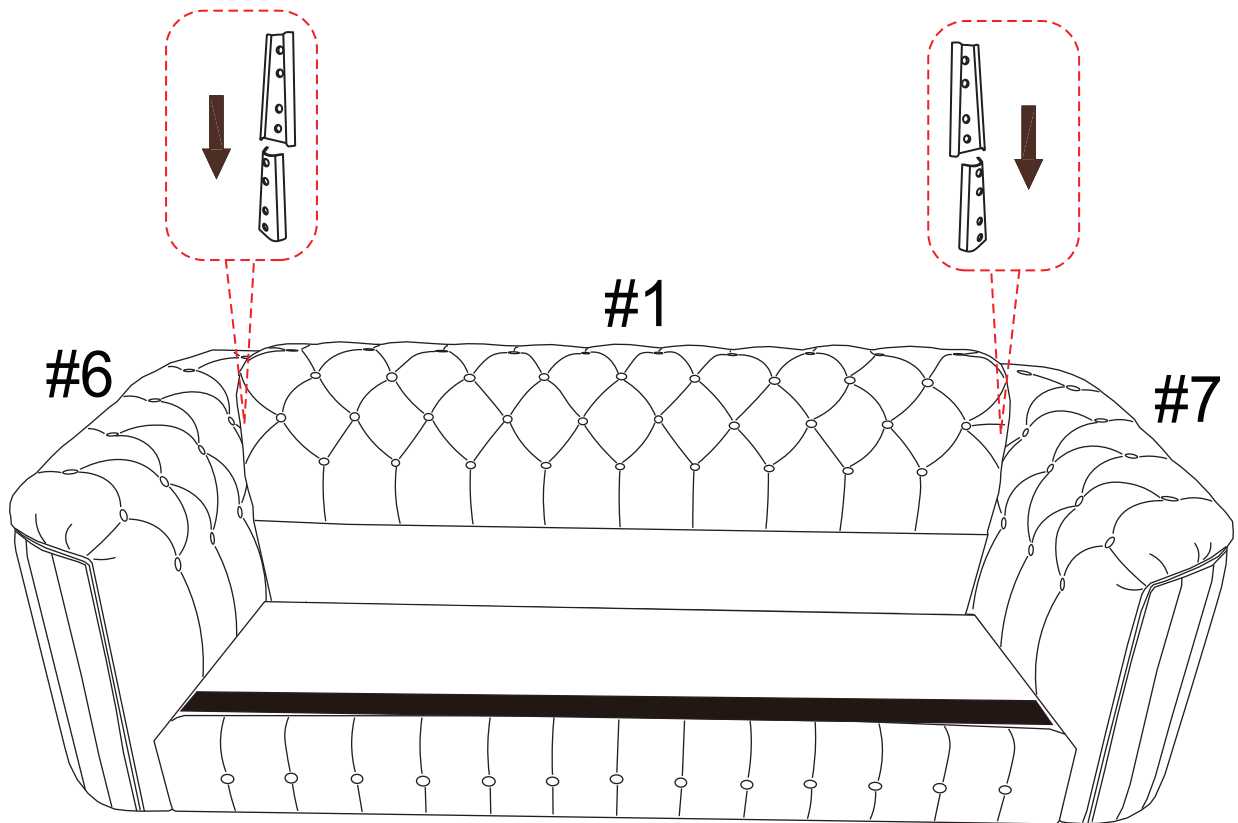

ASSEMBLY INSTRUCTIONS

STEP3:

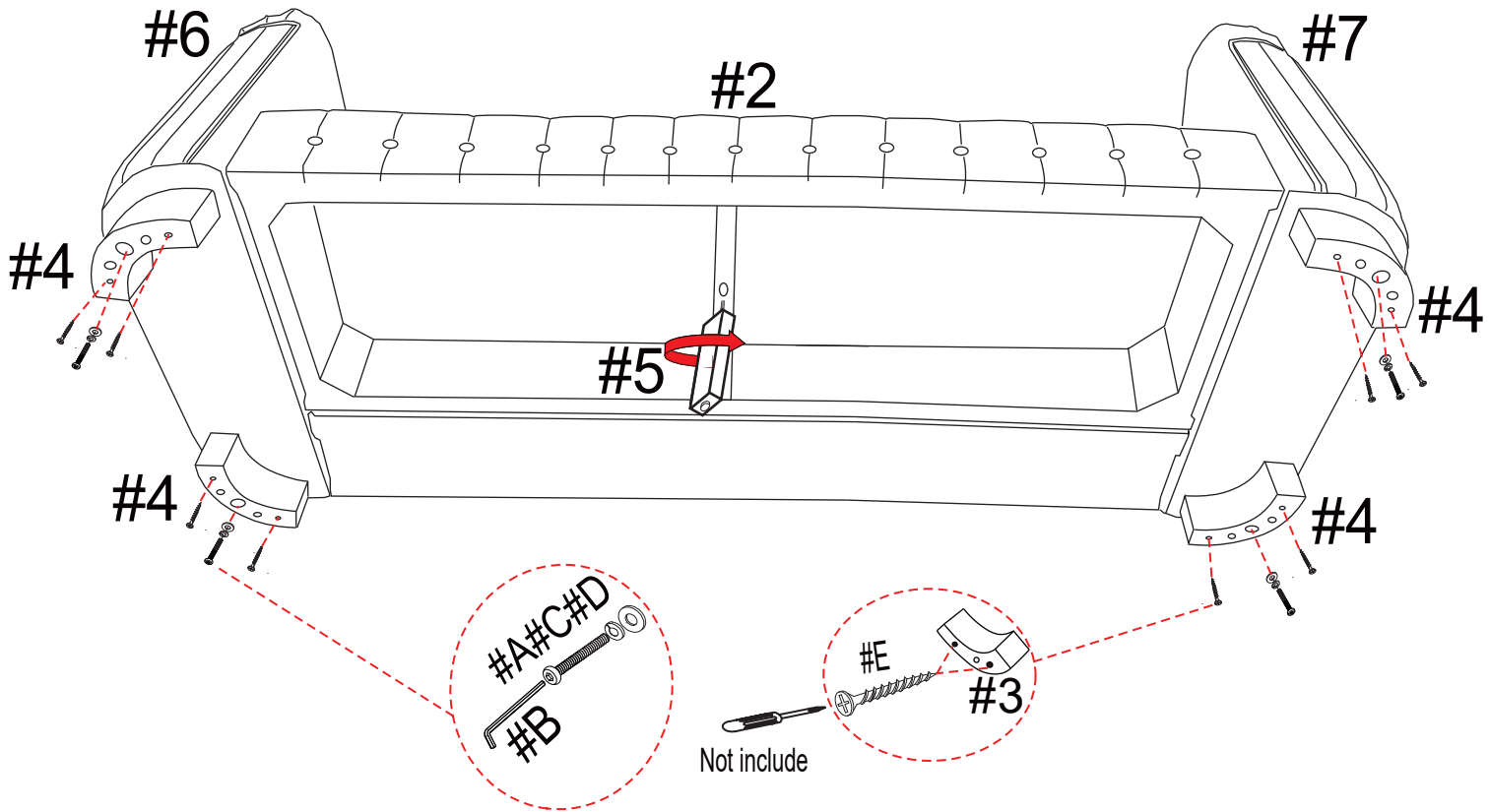



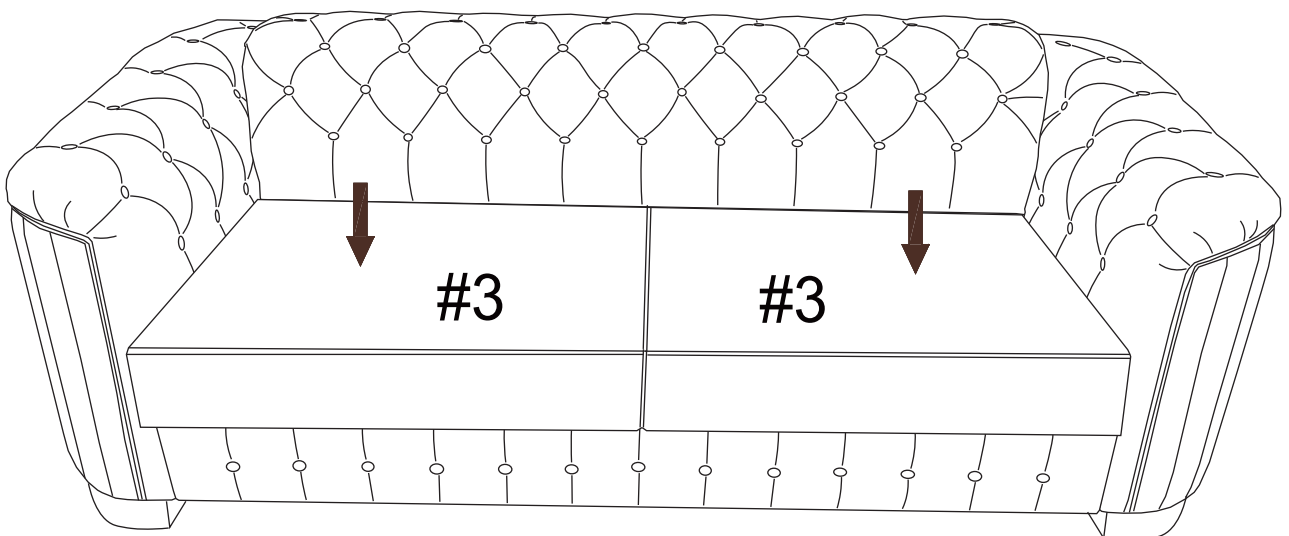

STEP4:

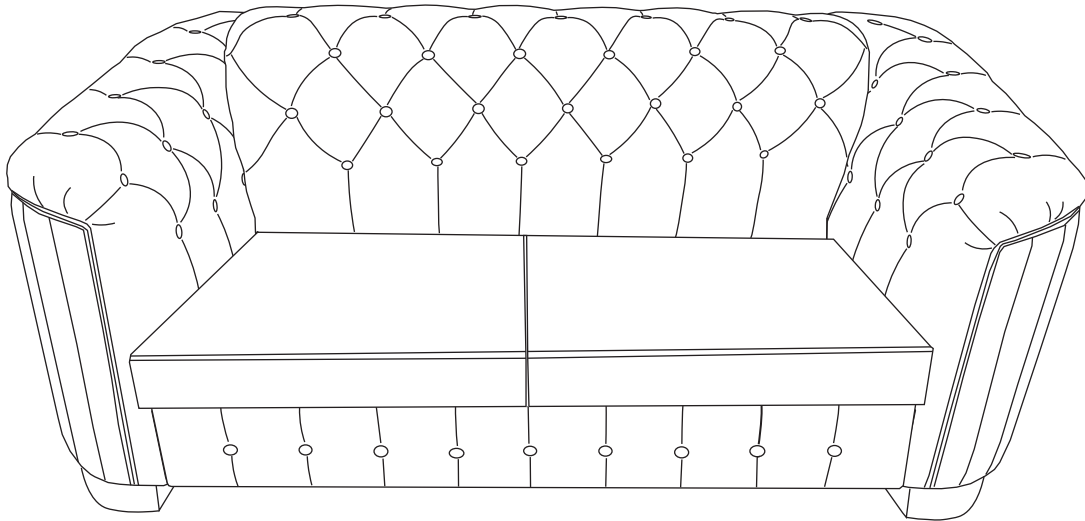

YAL-303-LOVESEAT

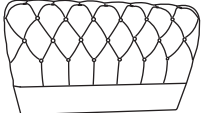
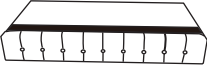
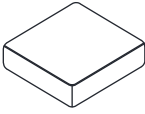

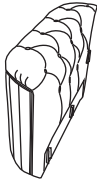
LOVESEAT is packed in 3 cases

Carton	Disignation	Part		Hardware
L1	Backrest	#1		
L2	Seat frame	#2		#A #B #C #D #E
	Cushion	#3		
	Leg	#4		
ARM	Left arm	#5		
	Right arm	#6		

ASSEMBLY INSTRUCTIONS

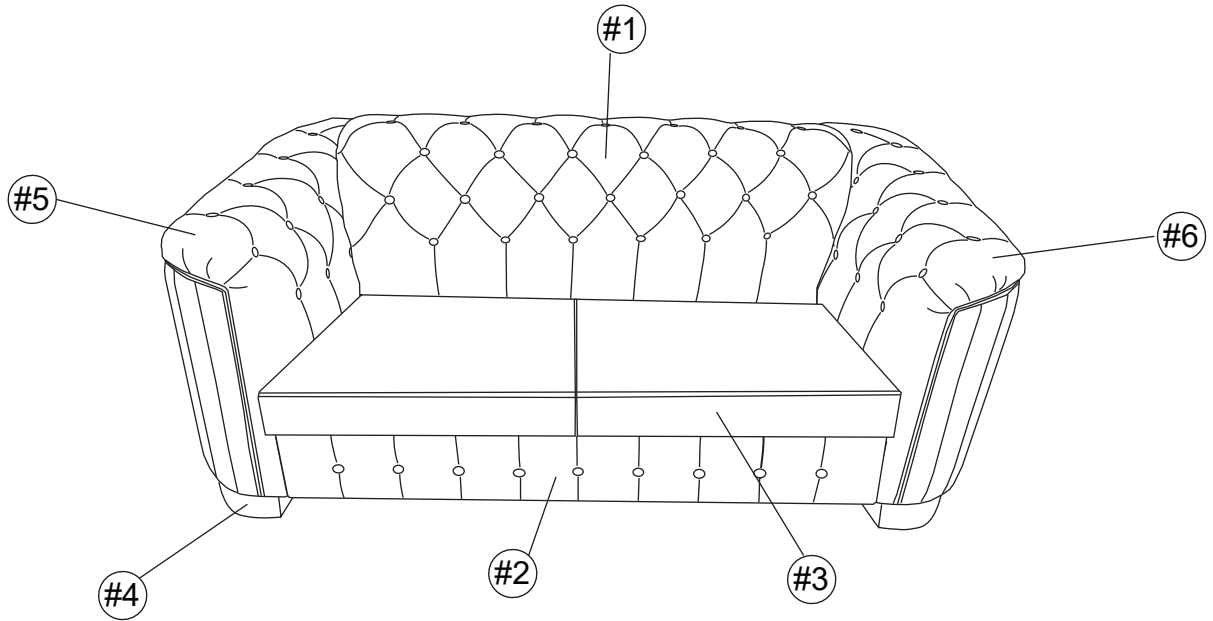

PARTS

#1 1 pc

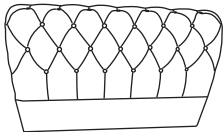

Backrest

#2 1 pc

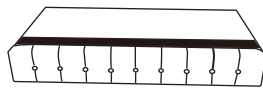

Seat frame

#3 2 pcs

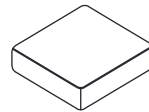

Cushion

#4 4 pcs



Leg

#5 1 pc

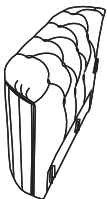

Left arm

#6 1 pc



Right arm

HARDWARE

#A 4 pcs



BOLT 2-1/2 "L

#B 1 pc



ALLEN KEY 100mm L

#C 4 pcs



FLAT WASHER 16mm

#D 4 pcs



SPRING WASHER

#E 8 pcs



Screw 60mm L

ASSEMBLY INSTRUCTIONS

STEP1:

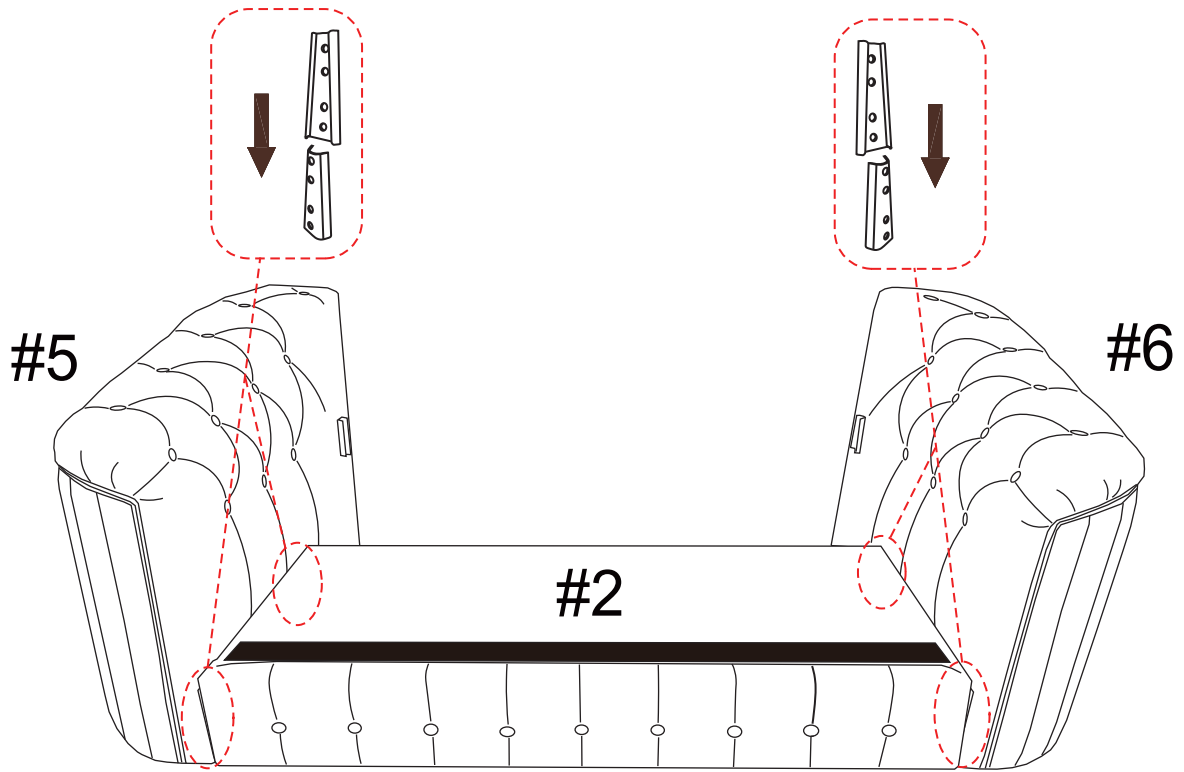



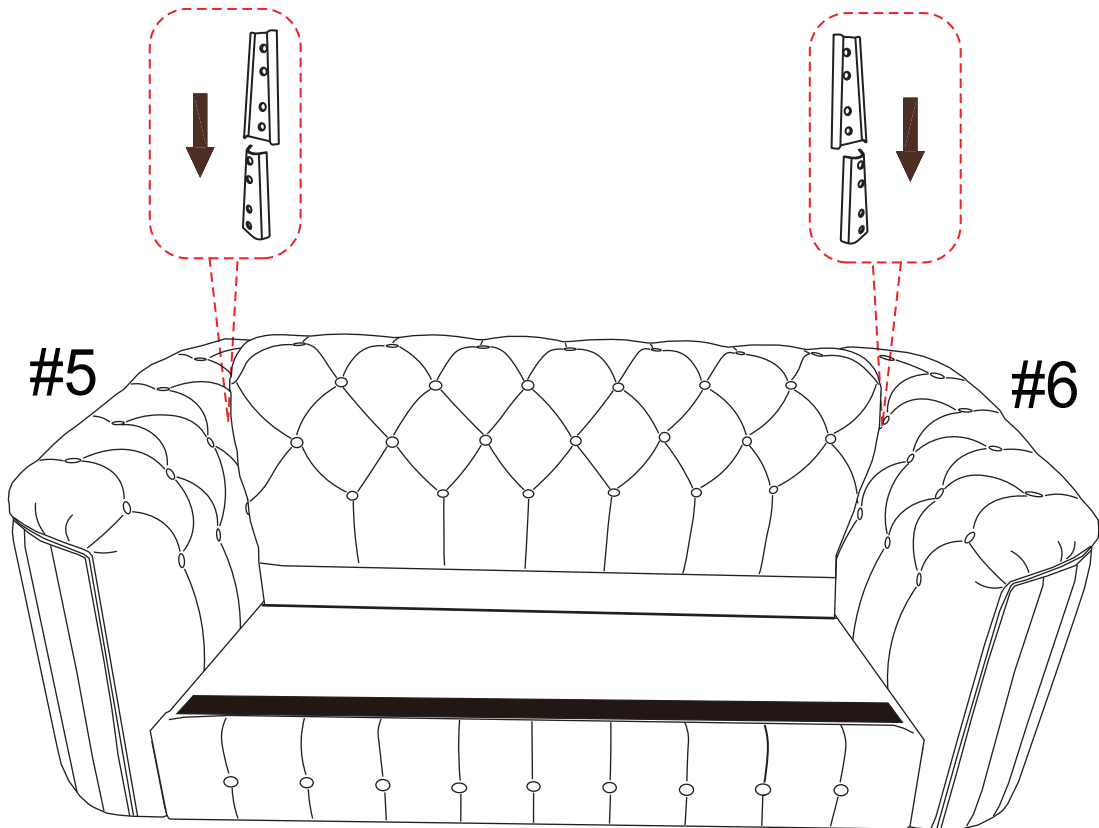

STEP2:

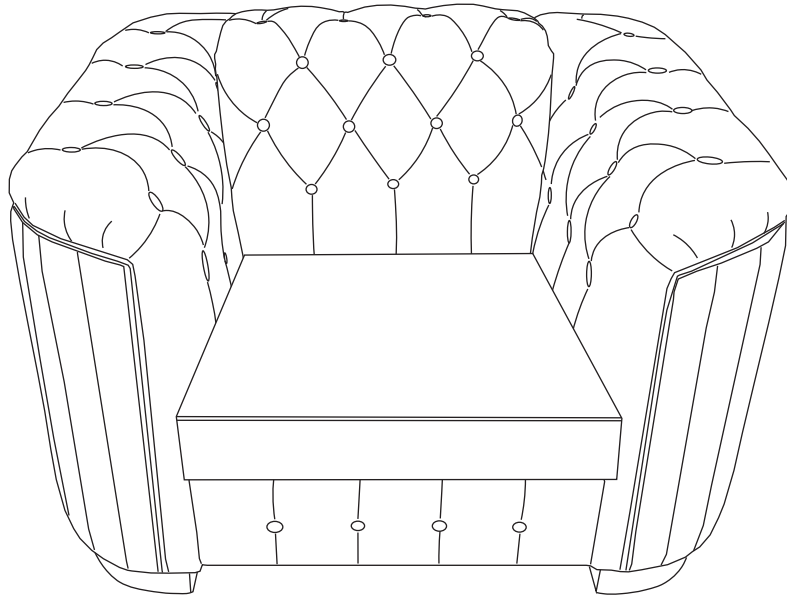

YAL-303-LOVESEAT

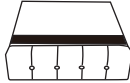
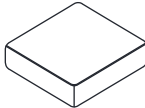

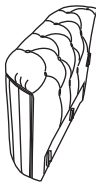
LOVESEAT is packed in 3 cases

Carton	Disignation	Part		Hardware
C1	Backrest	#1		
C2	Seat frame	#2		#A #B #C #D #E
	Cushion	#3		
	Leg	#4		
ARM	Left arm	#5		
	Right arm	#6		

ASSEMBLY INSTRUCTIONS

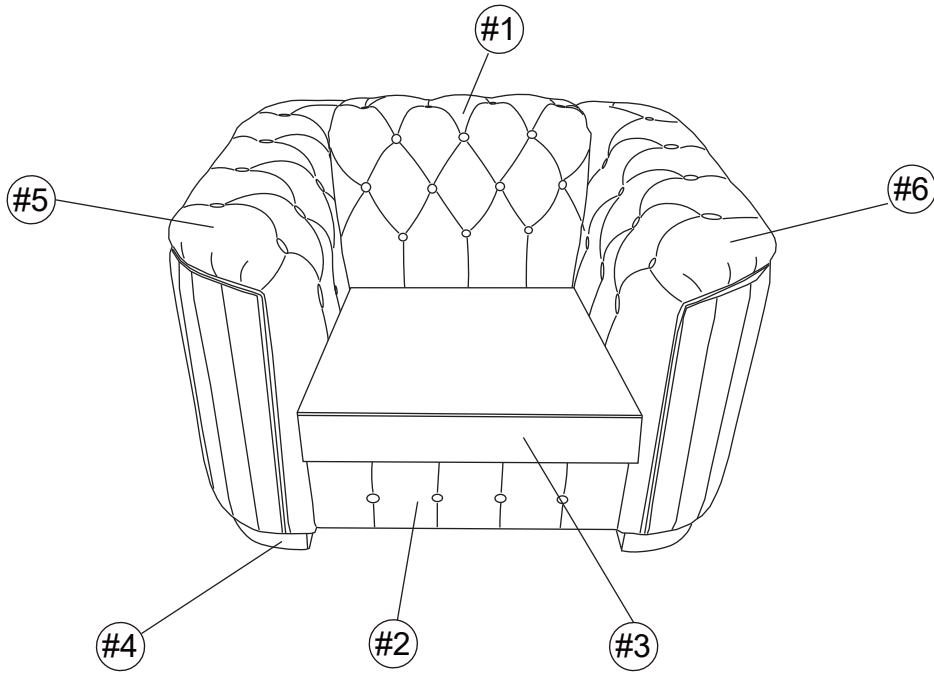

PARTS

#1 1 pc

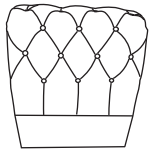

Backrest

#2 1 pc

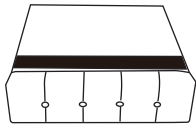

Seat frame

#3 1 pc

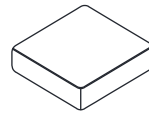

Cushion

#4 4 pcs



Leg

#5 1 pc

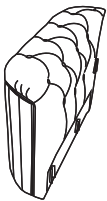

Left arm

#6 1 pc



Right arm

HARDWARE

#A 4 pcs



BOLT 2-1/2 "L

#B 1 pc



ALLEN KEY 100mm L

#C 4 pcs



FLAT WASHER 16mm

#D 4 pcs



SPRING WASHER

#E 8 pcs



Screw 60mm L

ASSEMBLY INSTRUCTIONS

STEP1:

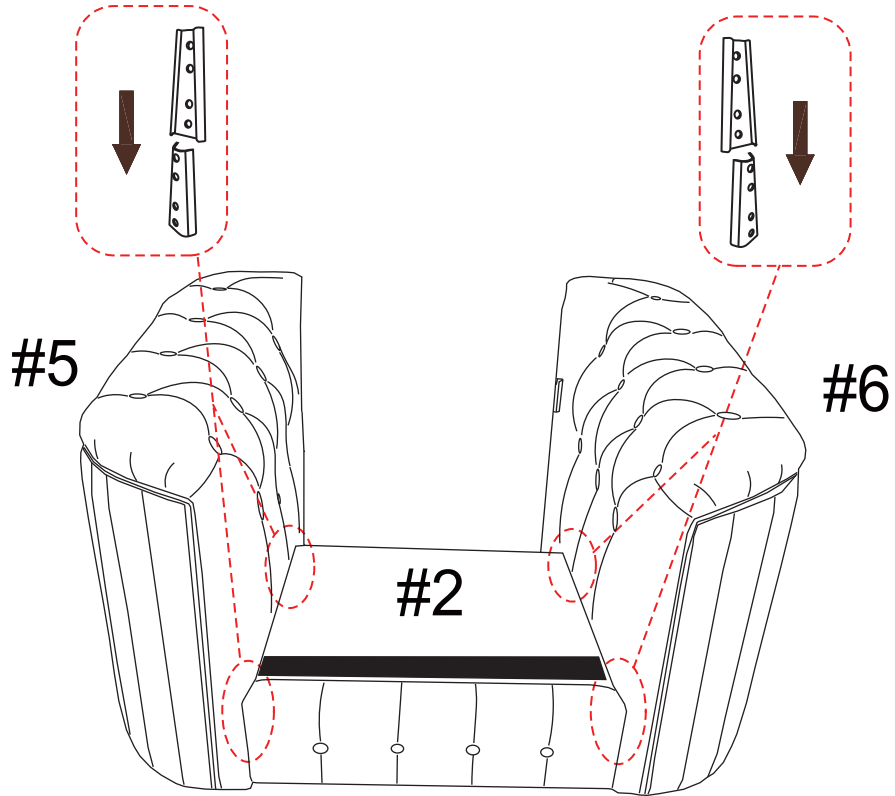

STEP2:

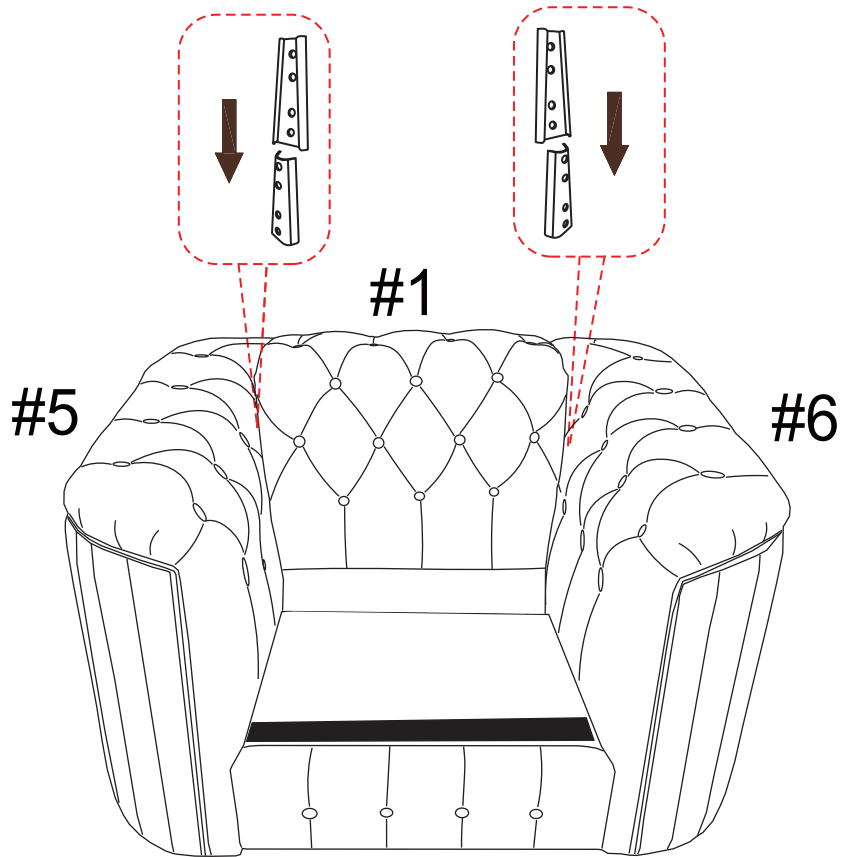

ASSEMBLY INSTRUCTIONS

STEP3:

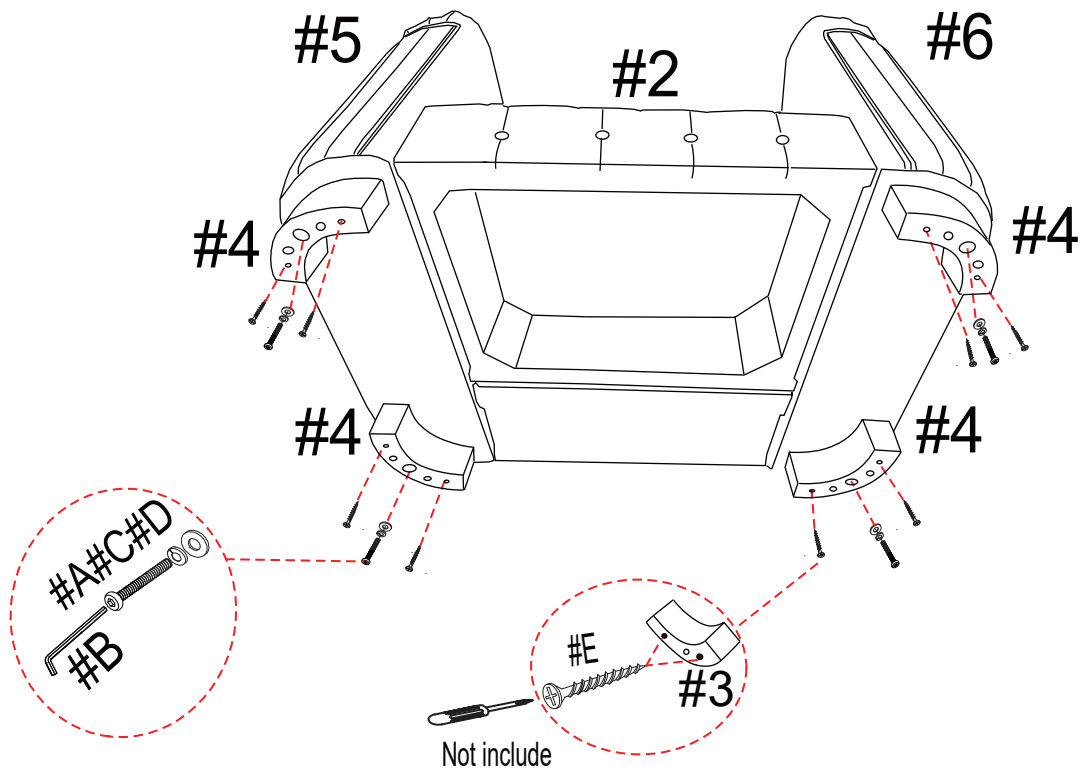

STEP4:

