

2 Place Seat Cushion (E) on assembled Stacking Arm Chair Frame.

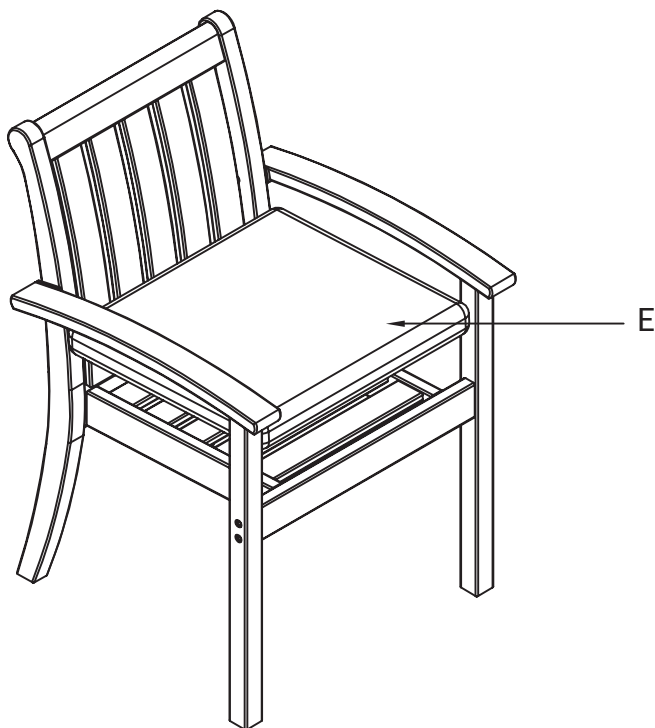

STACKING ARM CHAIR

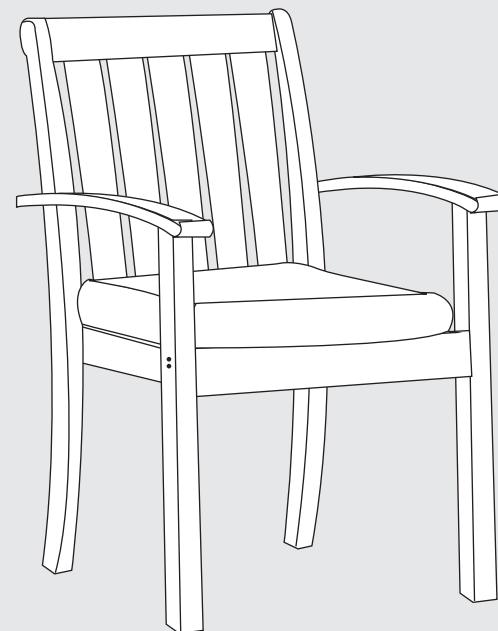

ADULT ASSEMBLY REQUIRED

If you are missing any parts or have any questions regarding assembly, do not return this item to the retailers store. Please call our toll-free, customer service number and have this assembly manual open to the parts list ready to provide the model name, number and part name or number.



WARNING: This product may contain small components, please ensure they are kept away from small children.

PARTS AND HARDWARE

Avoid using sharp objects such as a knife to cut open packing as you may accidentally damage the upholstery.

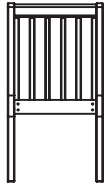

A. Back Leg
1x

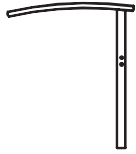

B. Left Leg
1x

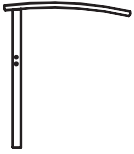

C. Right Leg
1x

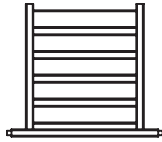

D. Seat
1x

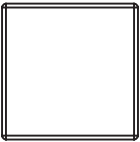

E. Seat Cushion
1x



F. Bolt
10x



G. Allen Key
1x

ASSEMBLY INSTRUCTIONS

Do not fully tighten bolts until assembly is complete.

- 1** Attach Back Leg (A) to Left Leg (B), Right Leg (C) and Seat Deck (D) using Bolts (F). Tighten using provide Allen Key (G).

