

ASSEMBLY INSTRUCTIONS



LOVE SEAT

ASSEMBLY INSTRUCTIONS

ASSEMBLY TIPS:

- 1.Remove hardware from box and sort by size.
- 2.Please check to see that all hardware and parts are present prior to start of assembly.
- 3.Please follow attached instruction in the same sequence as numbered to assure fast & easy assembly.



WARNING!

- 1.Don't attempt to repair or modify parts that are broken or defective. Please contact the store immediately.
- 2.This product is for home use only and not intended for commercial establishment.

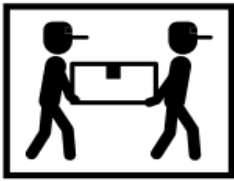

ASSEMBLY TIME PER UNIT:

15 MINUTES

PARTS IDENTIFICATION

A SEAT
1PC

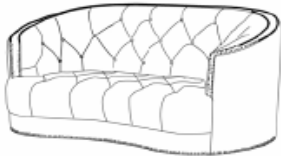

B LEG
4PC

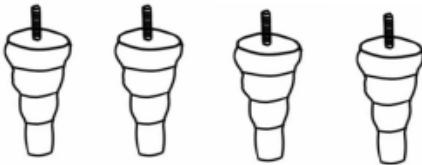

C PILLOW
2PC



ASSEMBLY INSTRUCTIONS

STEP 1

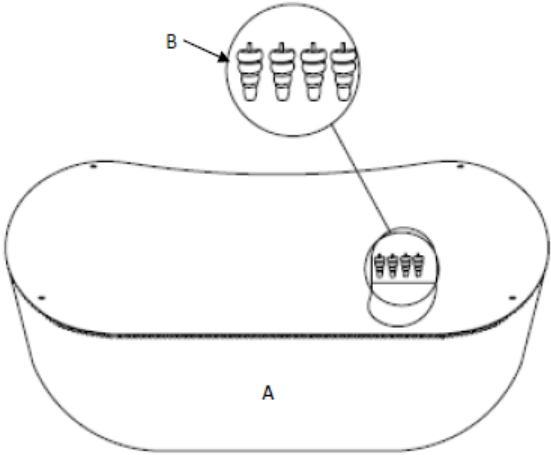

STEP 2

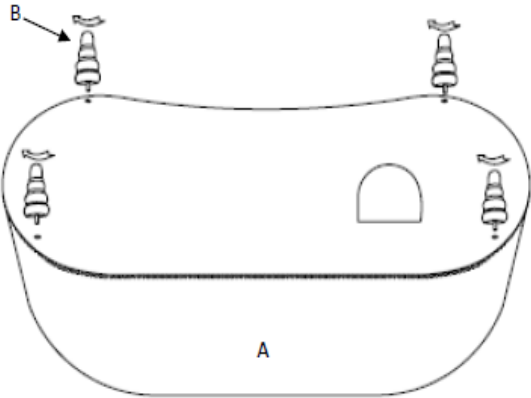

STEP 3

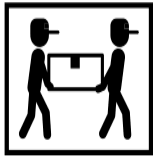
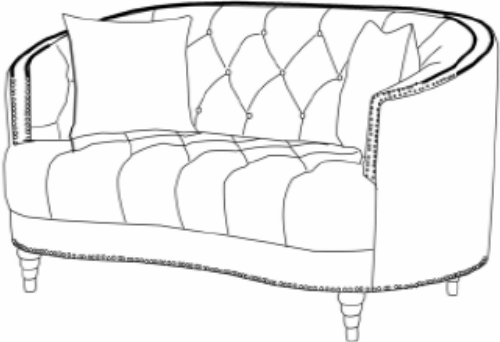

PRODUCT/PART DIMENSIONS

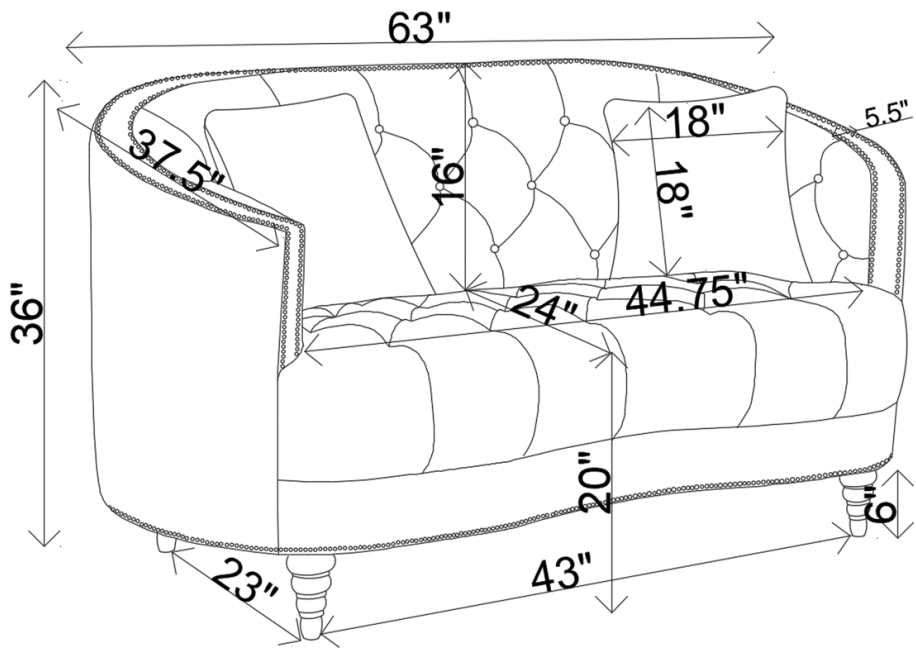

Note: Dimension tolerance $\pm 5\%$