

ASSEMBLY INSTRUCTION

INSTRUCTIONS DE MONTAGE

TWIN XL BED

This set included 2 boxex if do not receive full 2 boxex. Please contact our customer service team



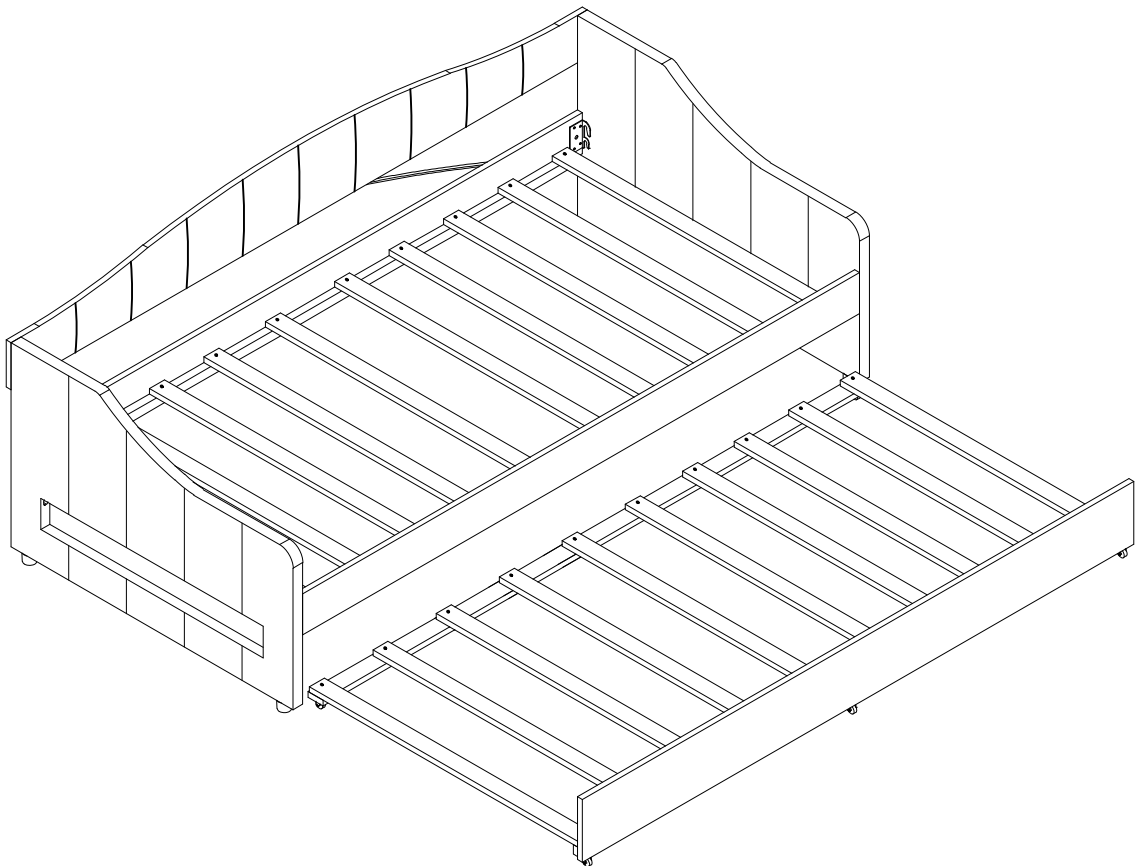

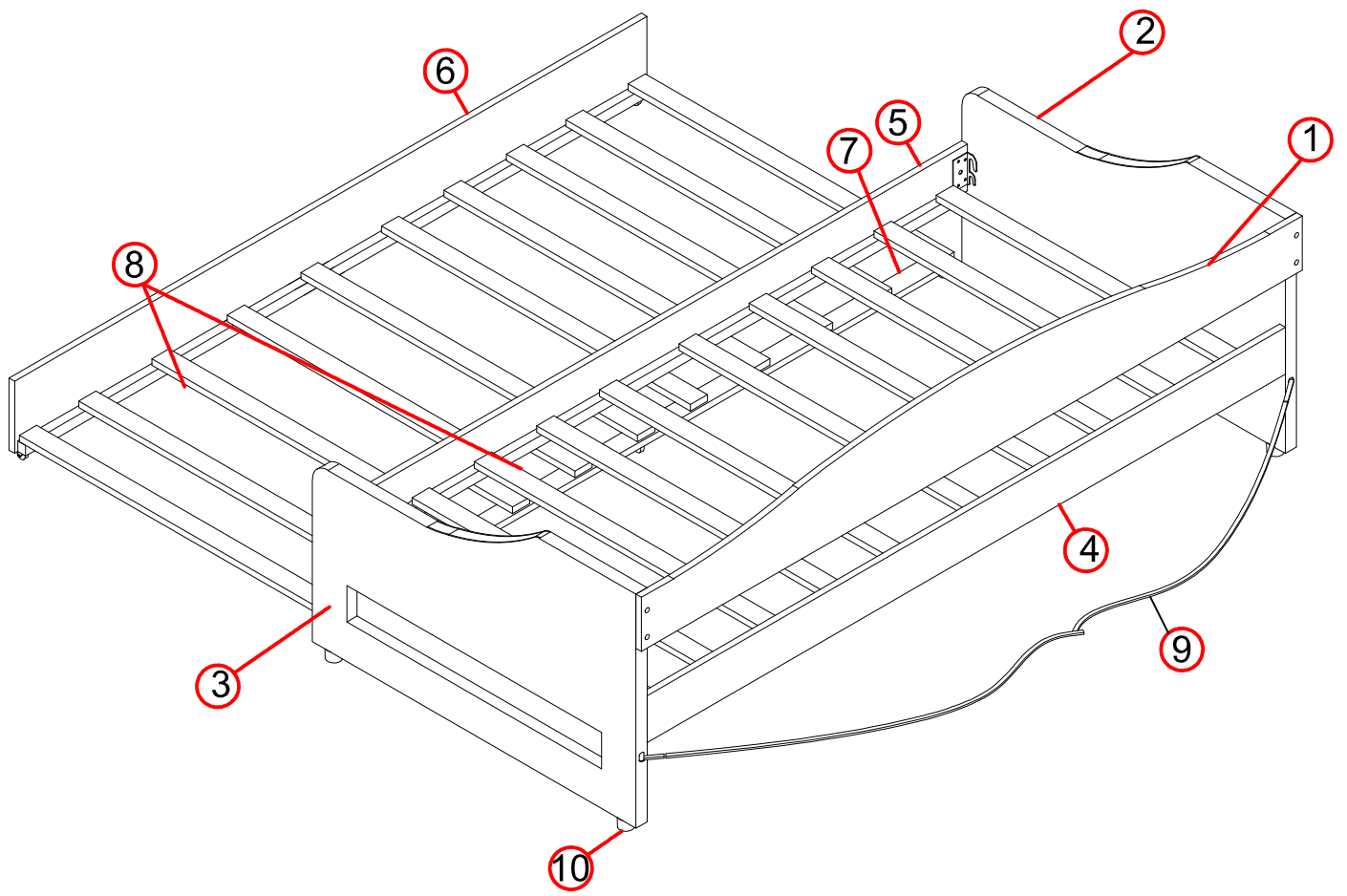
Cet ensemble comprenait 2 boxex si vous ne recevez pas 2 boxex complets. Veuillez contacter notre service client



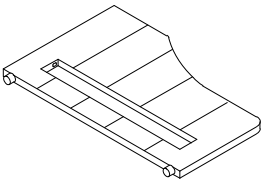
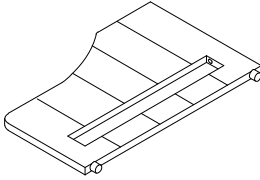
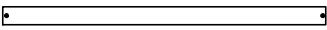

Part List

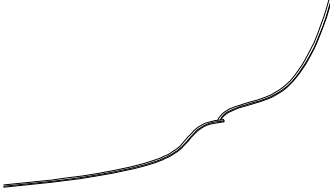
(Liste des pièces)

<p>2</p>  <p>Side board Right -1pc Buffet latéral Droit -1 pièce</p>	<p>3</p>  <p>Side board Left -1pc Buffet latéral gauche - 1 pièce</p>	<p>8</p>  <p>Slates-12pcs BARRES DE SUPPORT - 12 PCS</p>
<p>10</p>  <p>Legs - 4pcs (JAMBE-4pcs)</p>	<p>9</p>  <p>Connection wire-1pc Fil de liaison - 1 PC</p>	<p>Hardware (Matériel)</p> 

BOX 2/2: N709P207083A/N709P207083E



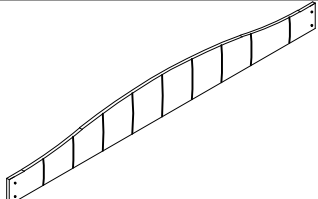
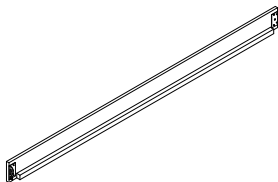
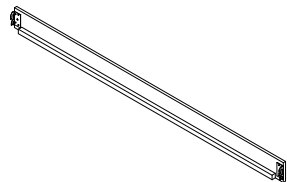
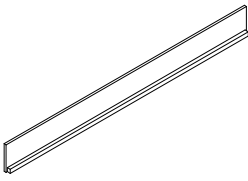
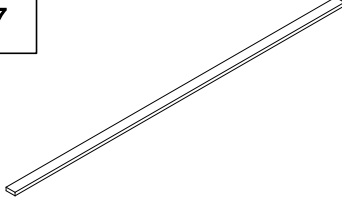
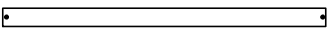





ENCADRÉ 1/2 : N709P207083A / N709P207083E

<p>1</p>  <p>Head board -1pc Tête de lit - 1 pièce</p>	<p>4</p>  <p>Back Rails -1pc Dos de barrière - 1 pièce</p>	<p>5</p>  <p>Front Rails -1pc Rails avant - 1 pièce</p>
<p>6</p>  <p>Drawer front - 1pcs façade de tiroir - 1 pièces</p>	<p>7</p>  <p>support behind the drawer -1pc support derrière les tiroirs -1 pièce</p>	<p>8</p>  <p>Slates-8pcs BARRES DE SUPPORT - 8 PCS</p>

HARDWARE

Check that you've received
all hardware listed below.

Hardware List (Liste du matériel)

No.	OUTLOOK (PERSPECTIVES)	NOTE	QTY
(A)		Bolts 5/16"x30 mm (Boulons 5/16"x30 mm)	8
(B)		Bolts 5/16"x30 mm (Boulons 5/16"x30 mm)	12
(C)		Spring washer Ø5/16"x12 mm (Rondelle élastiquer Ø5/16"x12 mm)	12
(D)		Allen key 80x25x4 mm (clé Alle`n 80x25x4 mm)	1
(K)		Bolts 5/16"x35 mm (Boulons 5/16"x35 mm)	4
(F)		Screws Ø4x30 mm (Des vis Ø4x30 mm)	40
(G)		Screws Ø4x15 mm (Des vis Ø4x15 mm)	20
(I)		LINKED METAL (MÉTAL LIÉ)	2
(H)		Wheel (Roue)	6

STEP 1 (ÉTAPE 1)

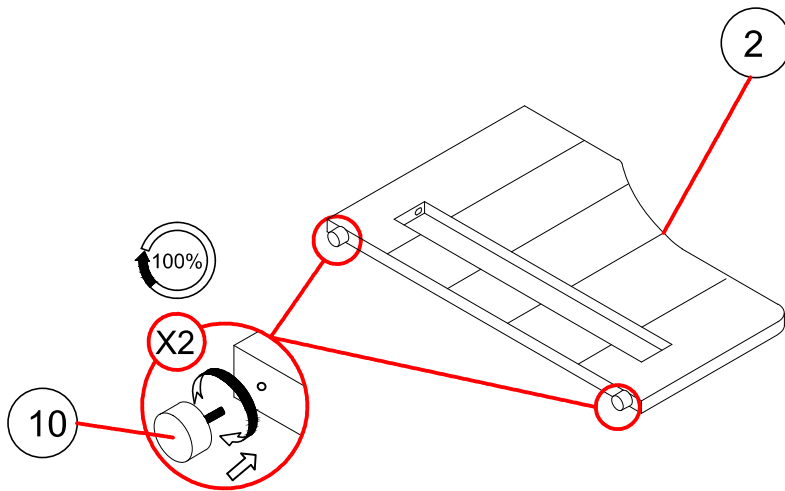
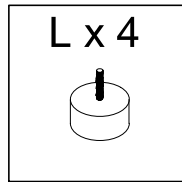

DETAILS 3 ARE ALSO SIMILAR ASSEMBLY
LES PARTIES 3 SONT AUSSI UN ASSEMBLAGE SIMILAIRE)

STEP 2 (ÉTAPE 2)

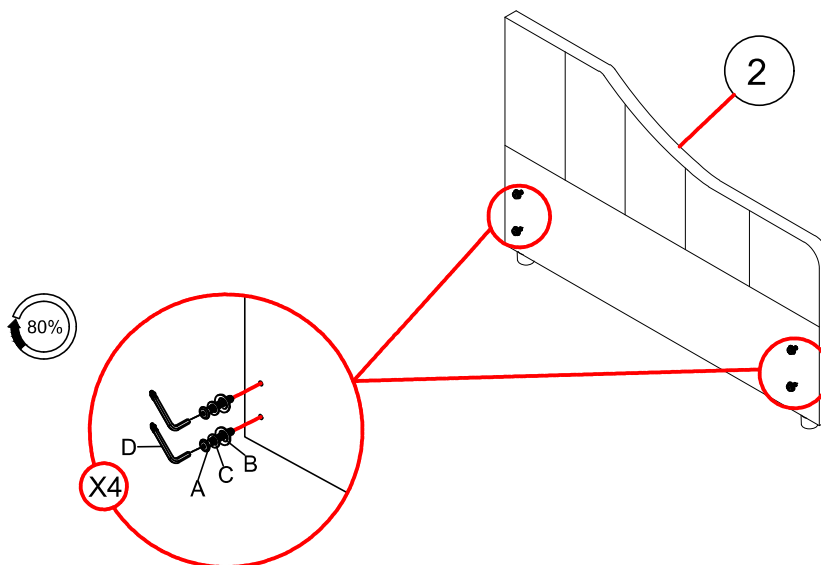
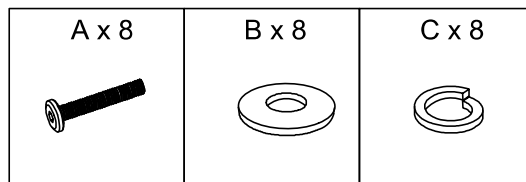

DETAILS 3 ARE ALSO SIMILAR ASSEMBLY
LES PARTIES 3 SONT AUSSI UN ASSEMBLAGE SIMILAIRE)

STEP 3 (ÉTAPE 3)

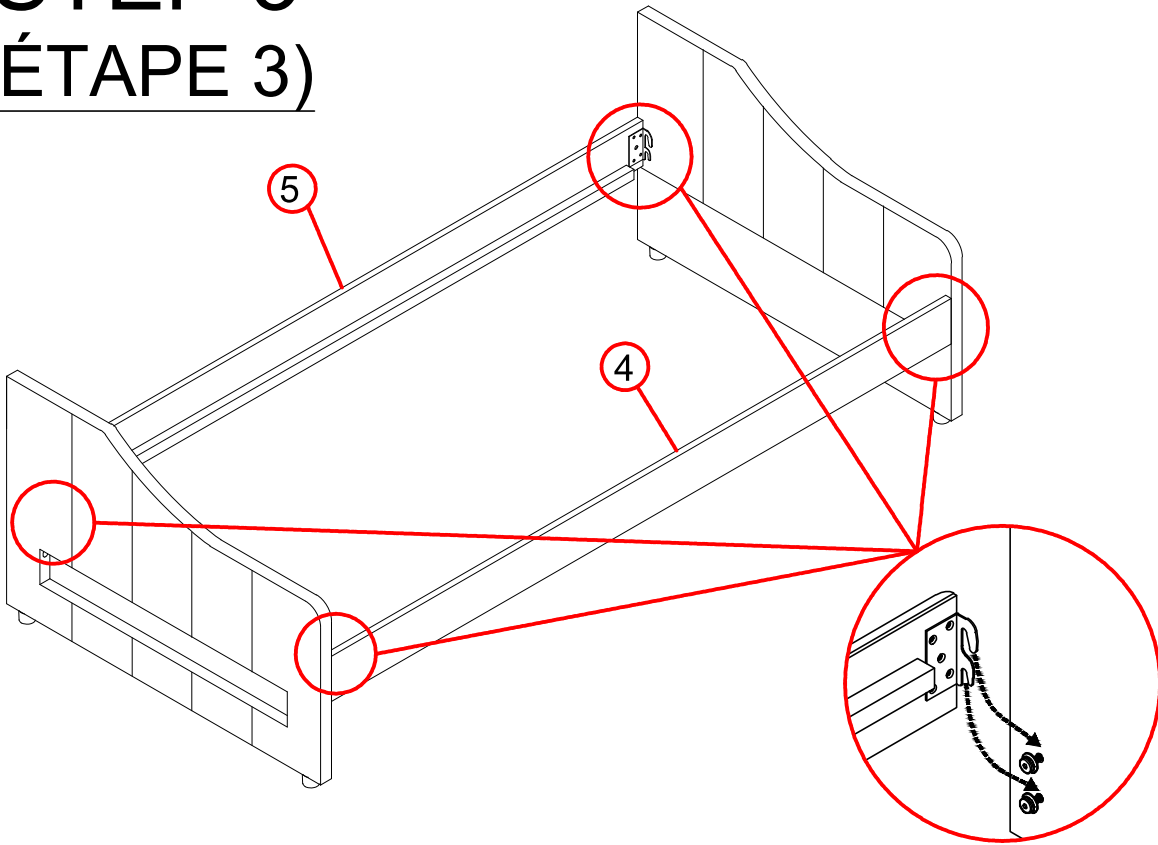

STEP 4 (ÉTAPE 4)

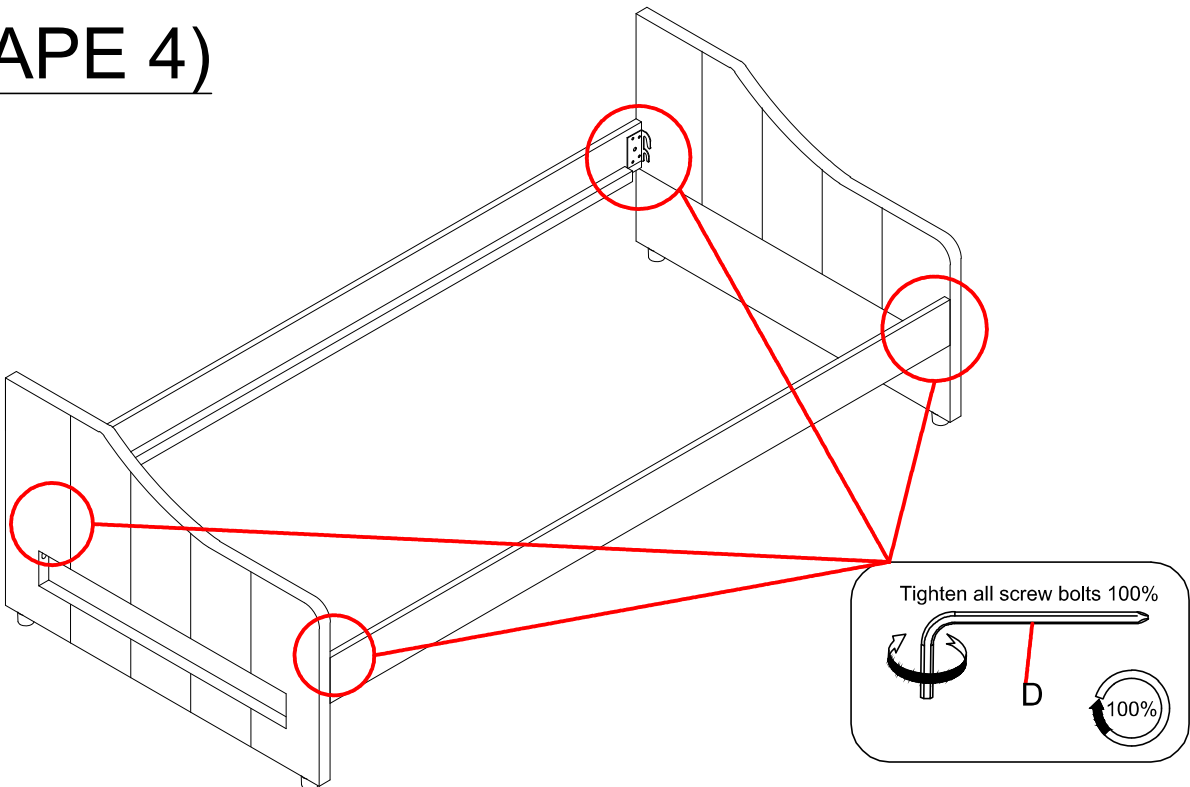

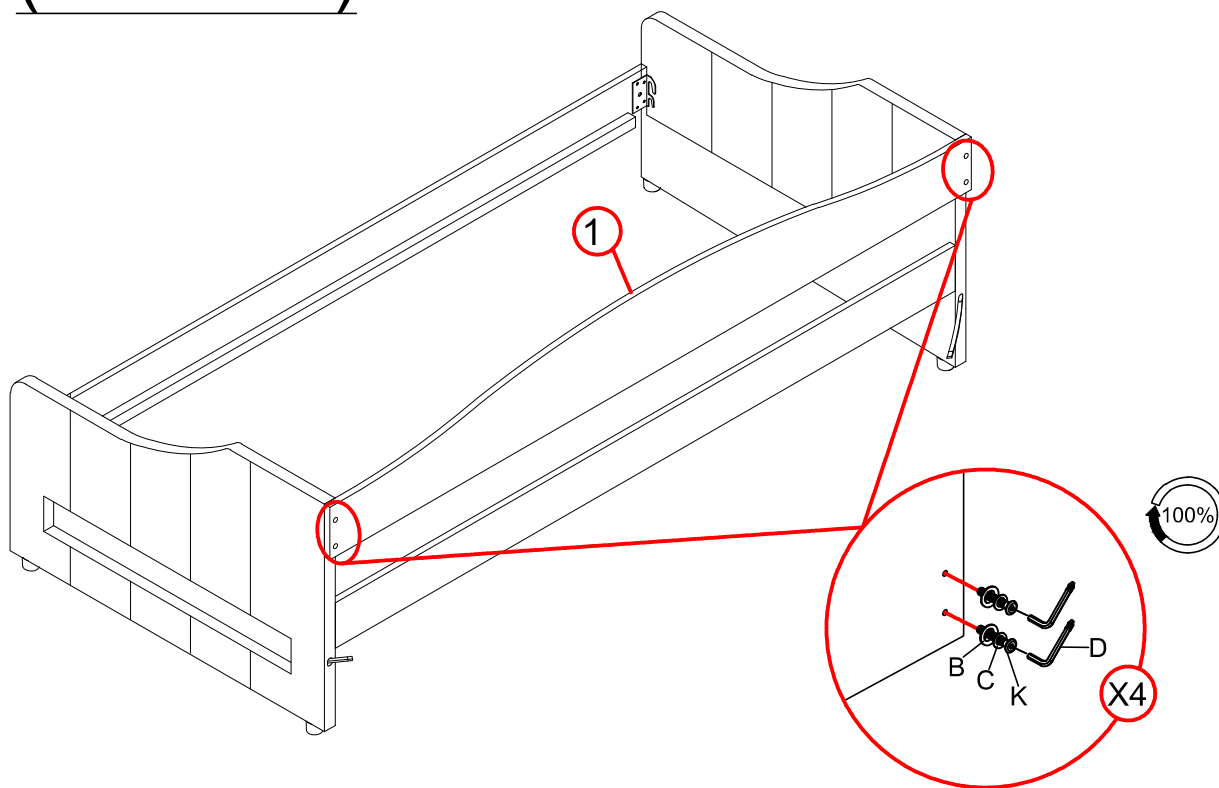
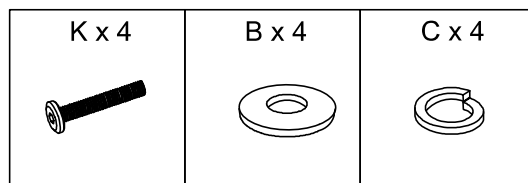

STEP 5 (ÉTAPE 5)

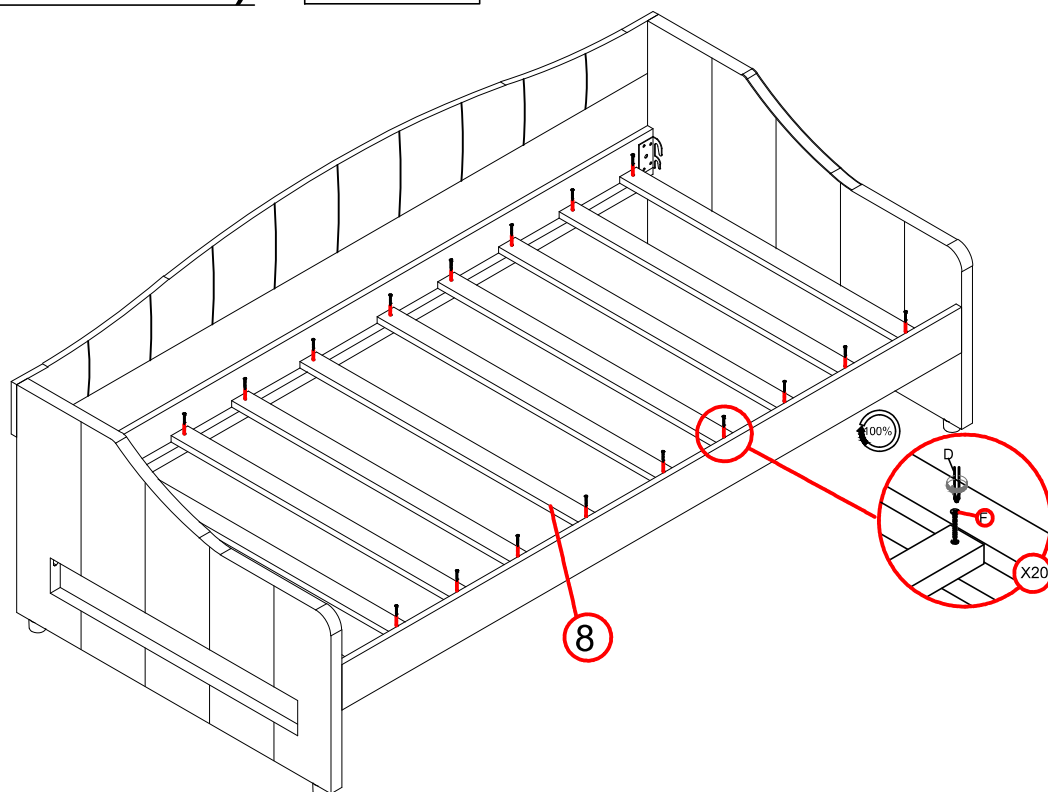
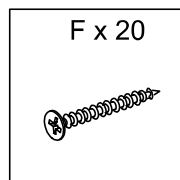

STEP 6 (ÉTAPE 6)



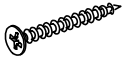
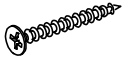

STEP 7 (ÉTAPE 7)

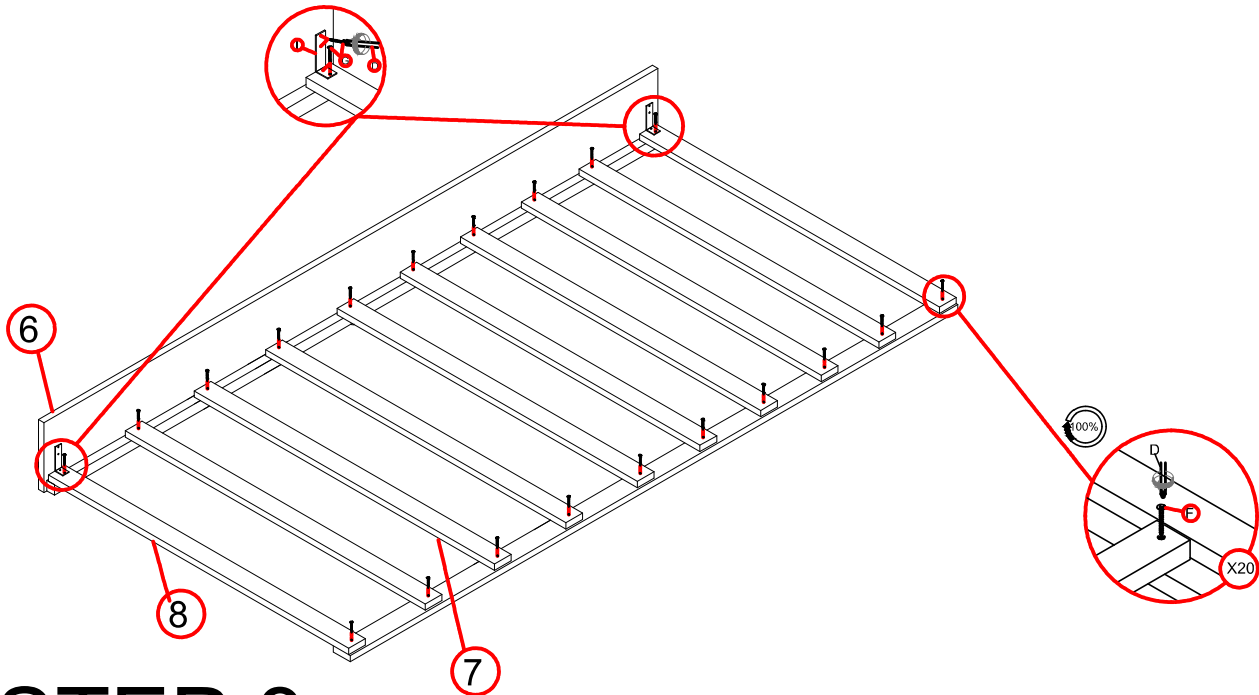
F x 20 	G x 8 	I x 2 
---	--	--



STEP 8 (ÉTAPE 8)

G x 12 	H x 6 
---	--

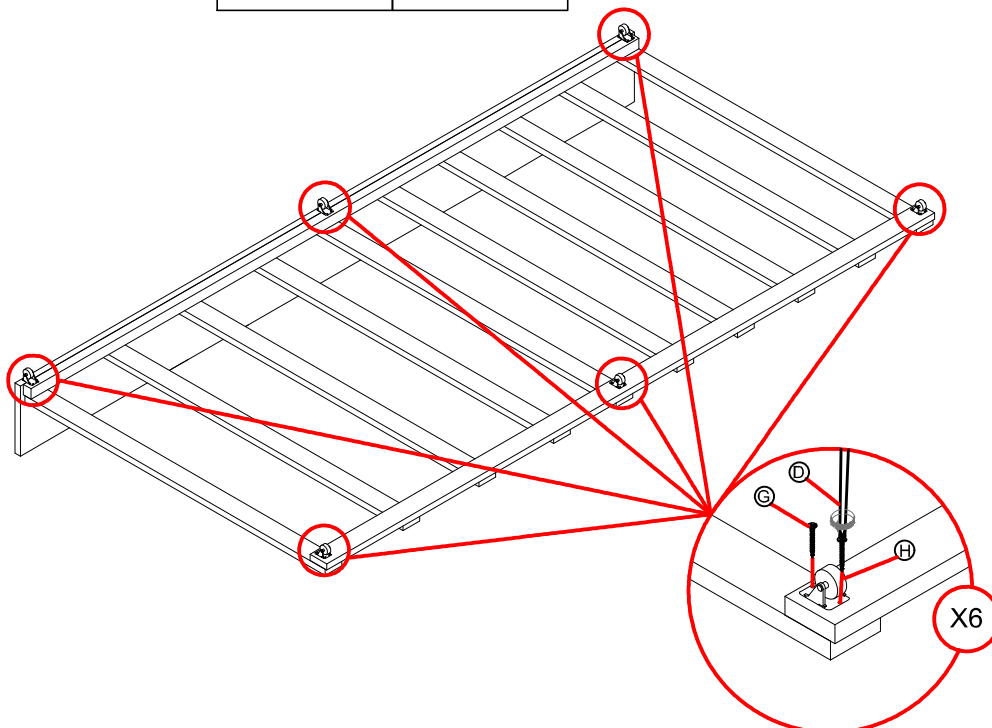

STEP 9

(ÉTAPE 9)

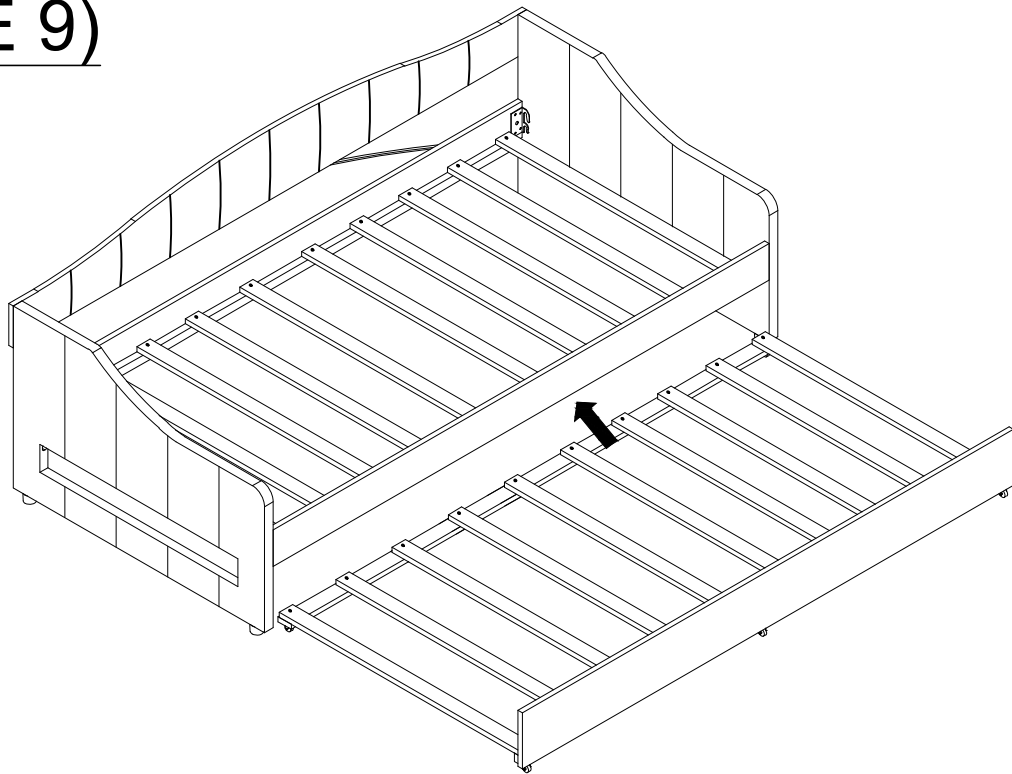

STEP 10

(ÉTAPE 10)

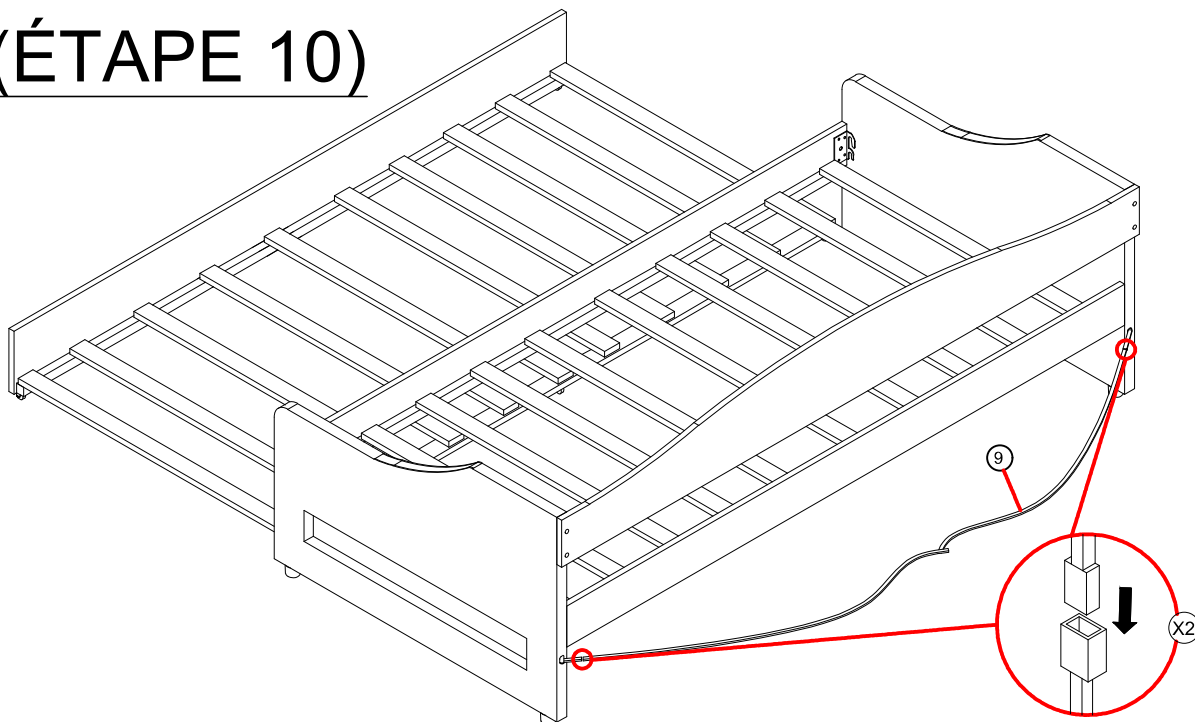

EXTENSION CORD CAN BE ATTACHED
TO ALL DEVICES WITH A USB PLUG

LA RALLONGE PEUT ÊTRE FIXÉE À
TOUS LES APPAREILS AVEC UNE
PRISE USB

COMPLETE

(COMPLET)

