

# JOINT WOOD&TOOL SHED

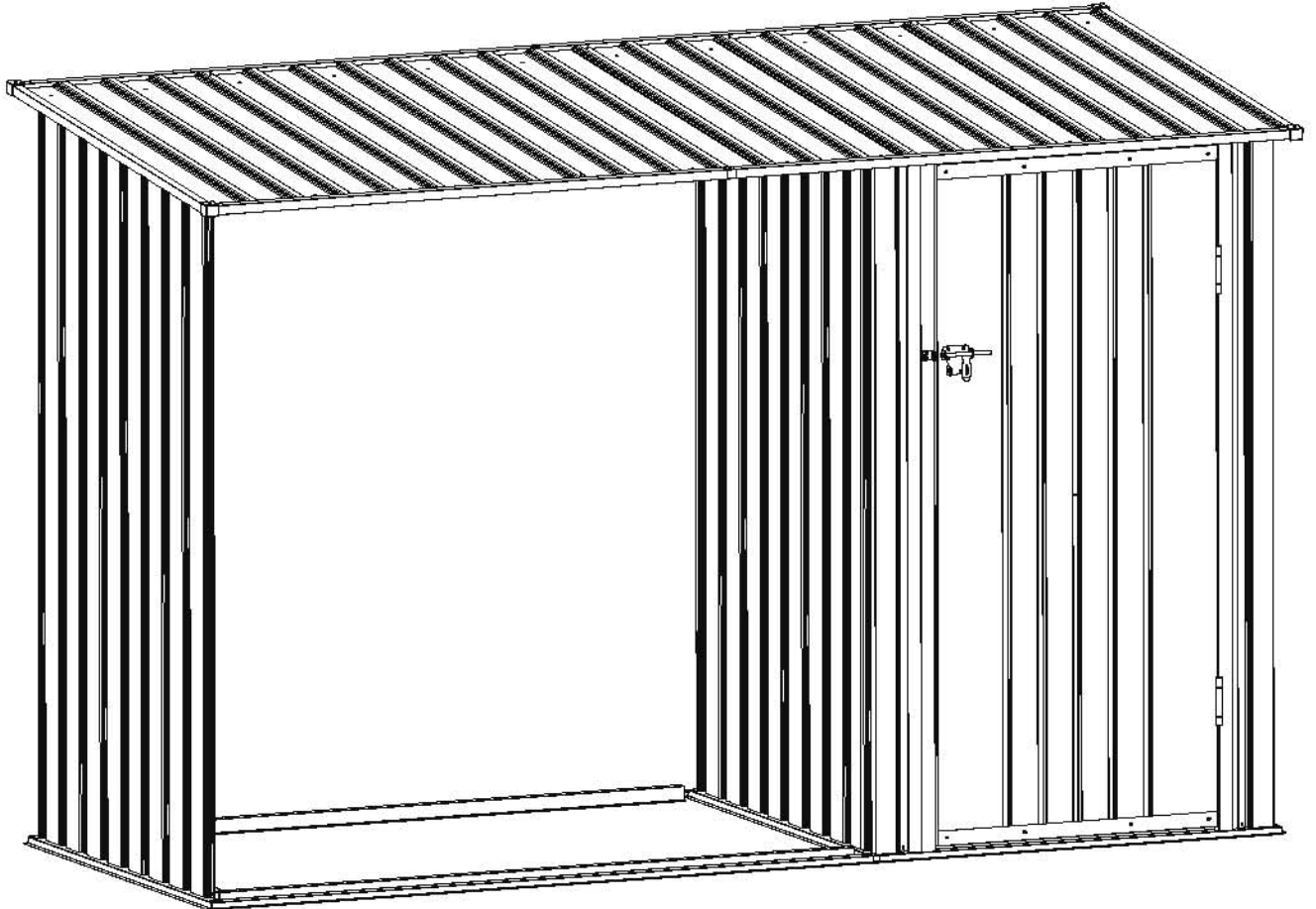

## ASSEMBLY INSTRUCTIONS

Requires two people and takes 2-3 hours for installation.

### **WARNING**

Please read the instruction manual carefully before assembly.  
Please assembly strictly in accordance with the instruction.  
Please double-check to ensure that all parts of the package contents intact.  
To avoid injury, work gloves are recommended during assembly.

### **Owner's Manual**

Before beginning construction, check local building codes regarding footings, location and other requirements. Study and understand this owner's manual. Important information and helpful tips will make your construction easier and more enjoyable.

**Assembly Instructions:** Instructions are supplied in this manual and contain all appropriate information for your building model. Review all instructions before you begin, and during assembly, follow the step sequence carefully for correct results.

**Parts and Parts List:** Check to be sure that you have all the necessary parts for building .

Separate contents of the carton by the part number while reviewing parts list.

The first few steps show how to join related parts to make larger sub assemblies which will be used later.

Familiarize yourself with the hardware and fasteners for easier use during construction.

These are packaged within the carton. Note that extra fasteners have been supplied for your convenience.

## **PLAN AHEAD**

**Watch the Weather:** Be sure the day you select to install your building is dry and calm.

Do not attempt to assemble your building on a windy day.

**Teamwork:** Whenever possible, two or more people should work together to assemble your building. One person can position parts or panels while the other is able to handle the fasteners and the tools.

**Tools and Materials:** These are some basic tools and materials you will need for the construction of your building. Decide which method of anchoring and the type of foundation you wish to use in order to form a complete list of the materials you will need.

## **CARE & MAINTENANCE**

**Finish:** For long lasting finish, periodically clean and wax the exterior surface. Touch-up scratches as soon as you notice them on your unit. Immediately clean the area with a wire brush; wash it and apply touch-up paint per manufacturer's recommendation.

**Roof:** Keep roof clear of leaves and snow with long handled, soft-bristled broom. Heavy amounts of snow on roof can damage building making it unsafe to enter. In snow country, Roof Strengthening Kits are available for most Arrow Buildings for added protection against heavy snow accumulation.

**Doors:** Always keep the door tracks clear of dirt and other debris that prevent them from sliding easily.

Lubricate door track annually with furniture polish or silicone spray. Keep doors closed and locked to prevent wind damage

**Fasteners:** Use all washers supplied to protect against weather infiltration and to protect the metal from being scratched by screws. Regularly check your building for loose screws, bolts, nuts, etc. and retighten them as necessary.

**Moisture:** A plastic sheet (vapor barrier) placed under the entire floor area with good ventilation will reduce condensation.

### **Other Tips....**







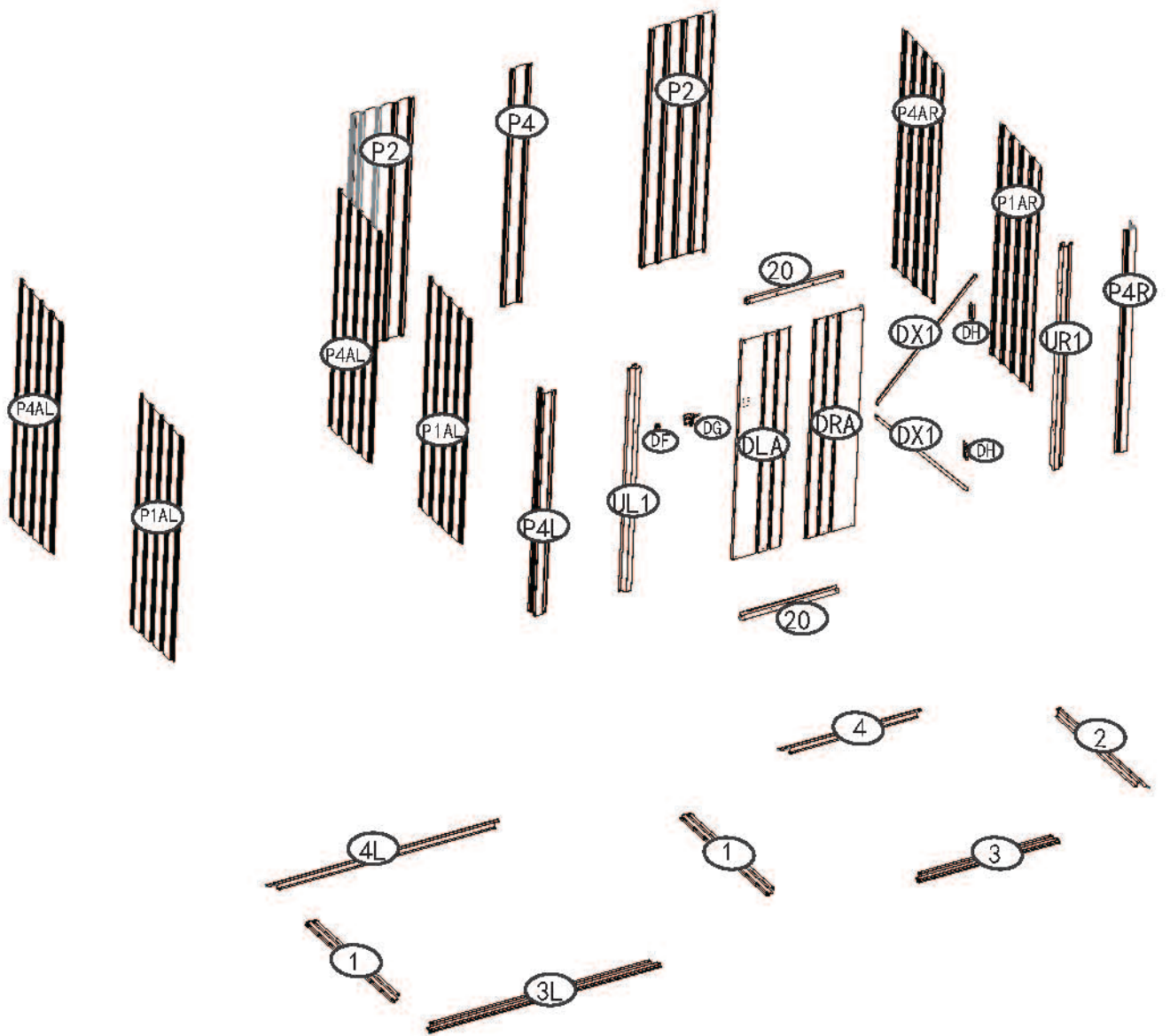
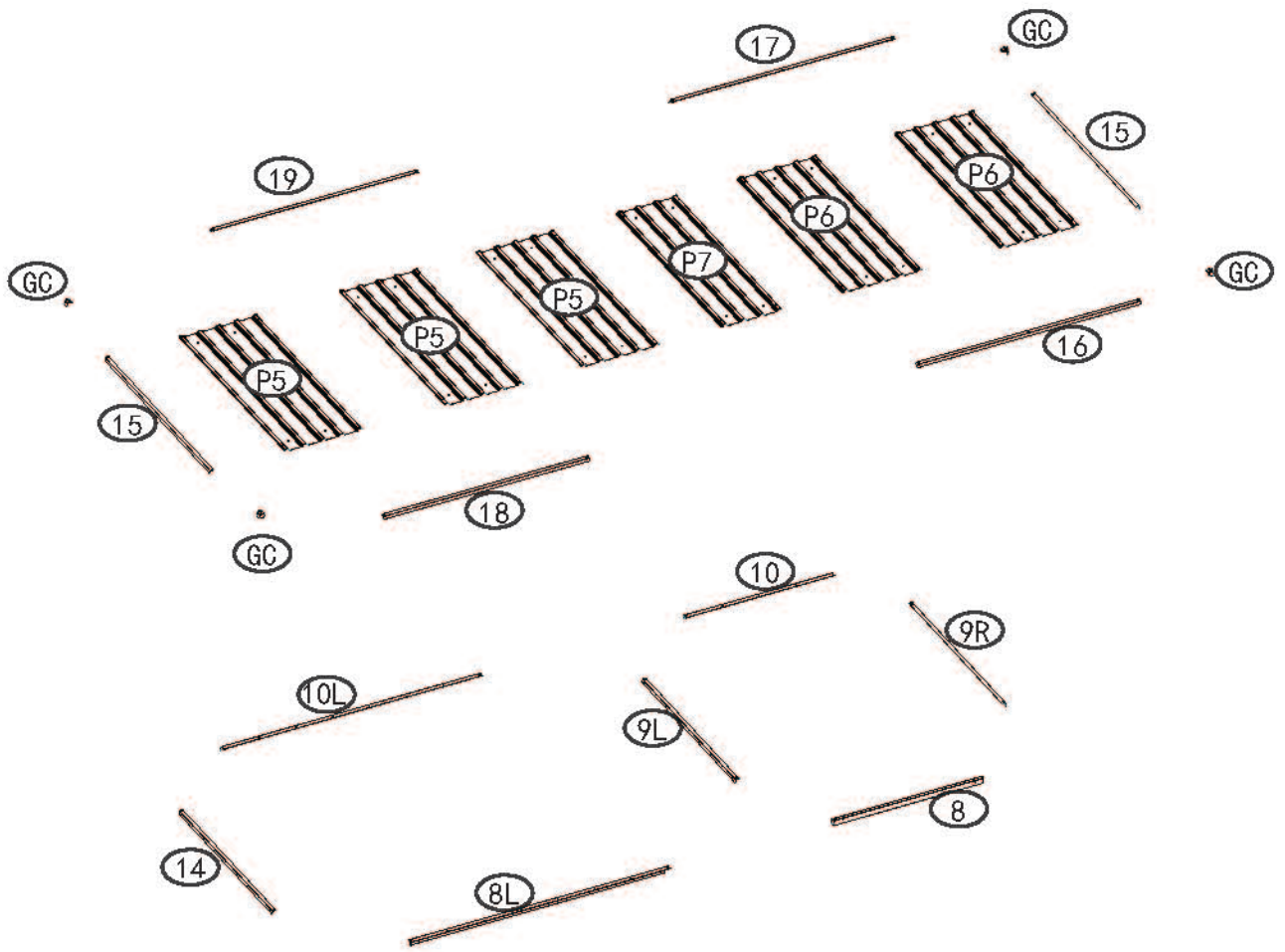



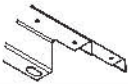

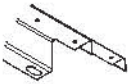
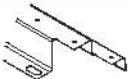
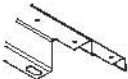



Wash off inked part numbers on coated panels with soap and water.











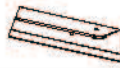





Silicone caulking may be used for watertight seals throughout the building.









**Do not store swimming pool chemicals in your building. Combustibles and corrosives must be stored in air tight approved containers.**





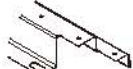

# PARTS LIST/LISTE de PIECES



No.	PIECES	Qty.
1		2
9L		1
2		1
3		1
4		1
P2		2
DF		1
DG		1
8		1
10		1
P4AL		2
P4		1
P4AR		1
P1AL		2
P1AR		1
P4L		1
P4R		1
UL1		1
UR1		1

No.	PIECES	Qty.
9R		1
15		2
16		1
GC		4
P7		1
P6		2
DH		2
20		2
DLA		1
DRA		1
DX1		2
F1		152
V2		150
F2		20
F3		16
S1		150



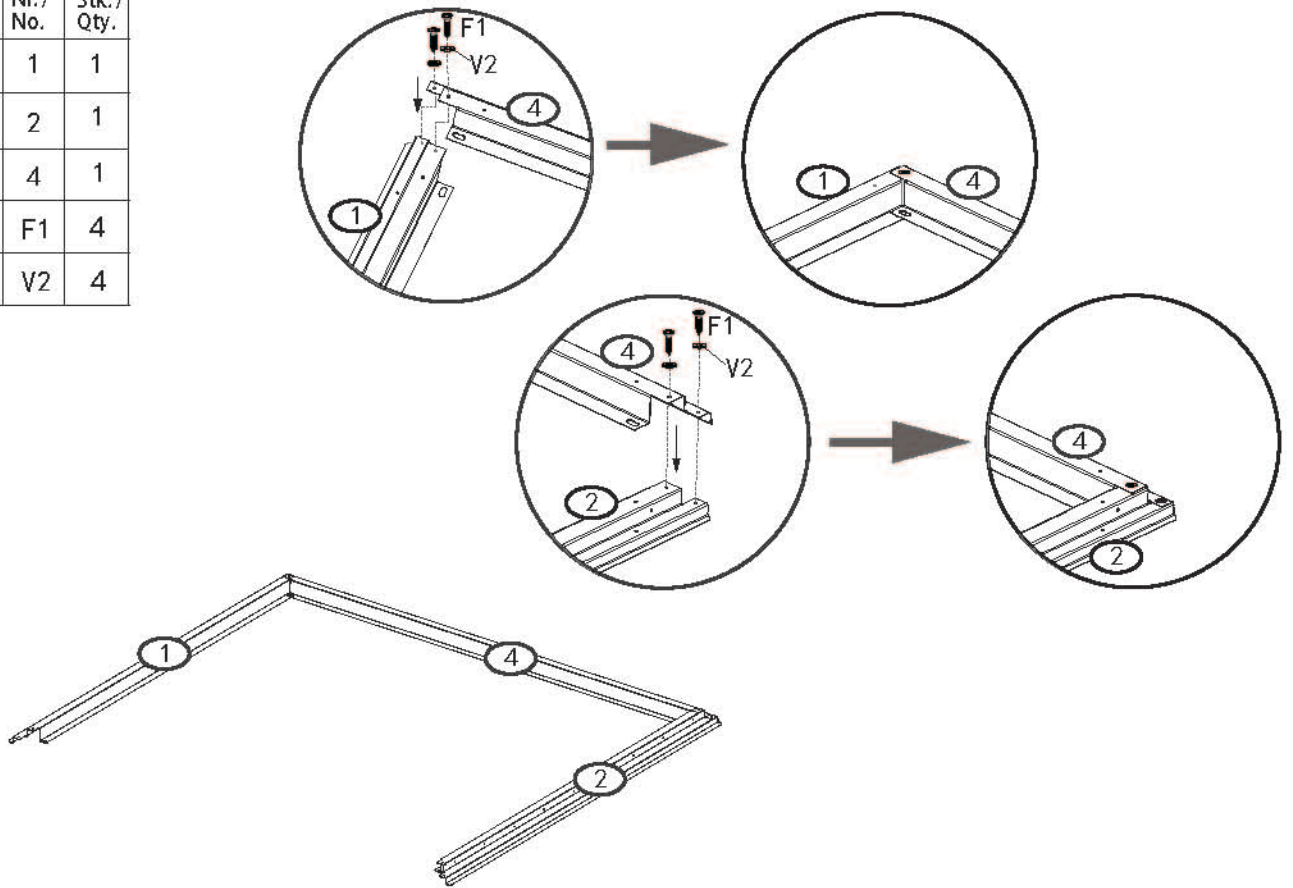

No.	PIECES	Qty.
17		1
P5		3
10L		1
8L		1
14		1
3L		1
4L		1
18		1
19		1

Pieces	Nr. / No.	Stk. / Qty.
	1	1
	2	1
	4	1
	F1	4
	V2	4

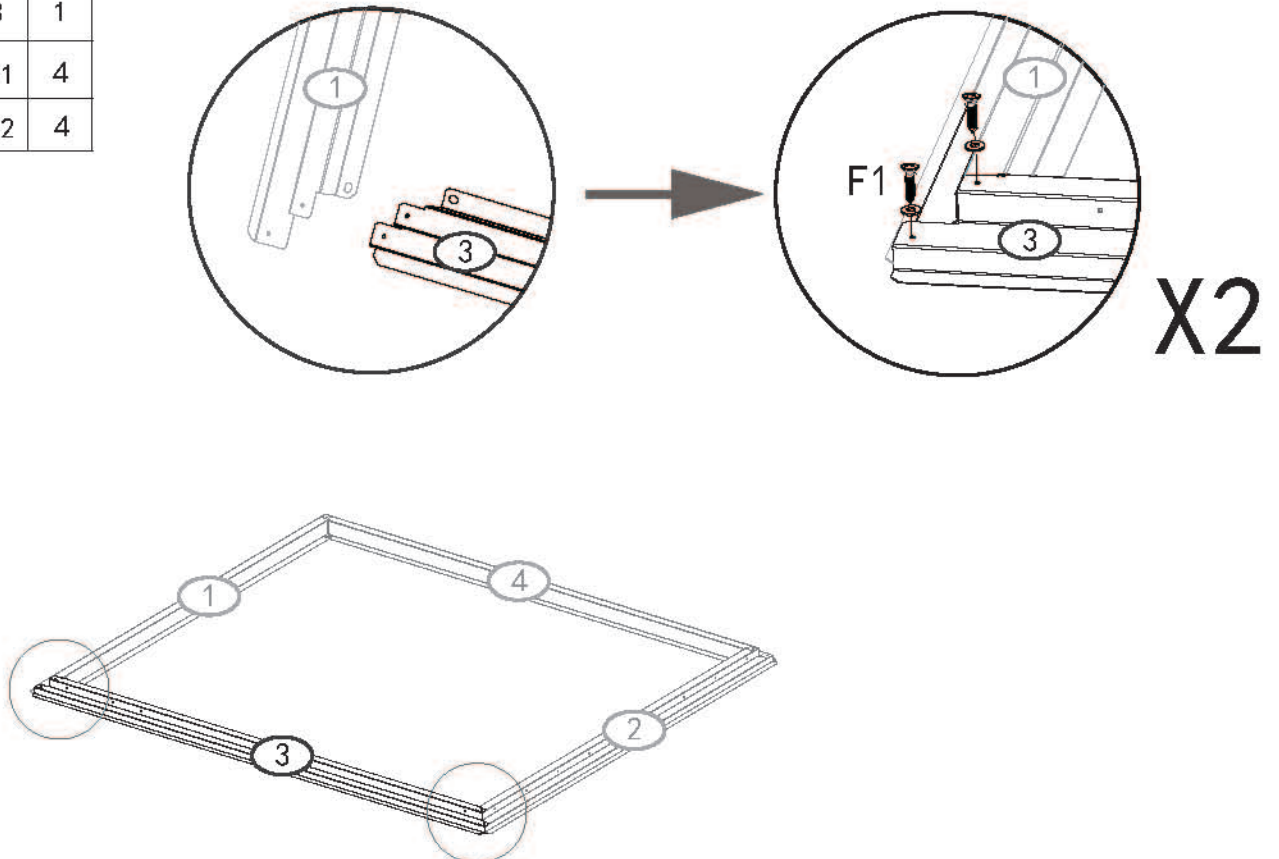



Pieces	Nr. / No.	Stk. / Qty.
	3	1
	F1	4
	V2	4



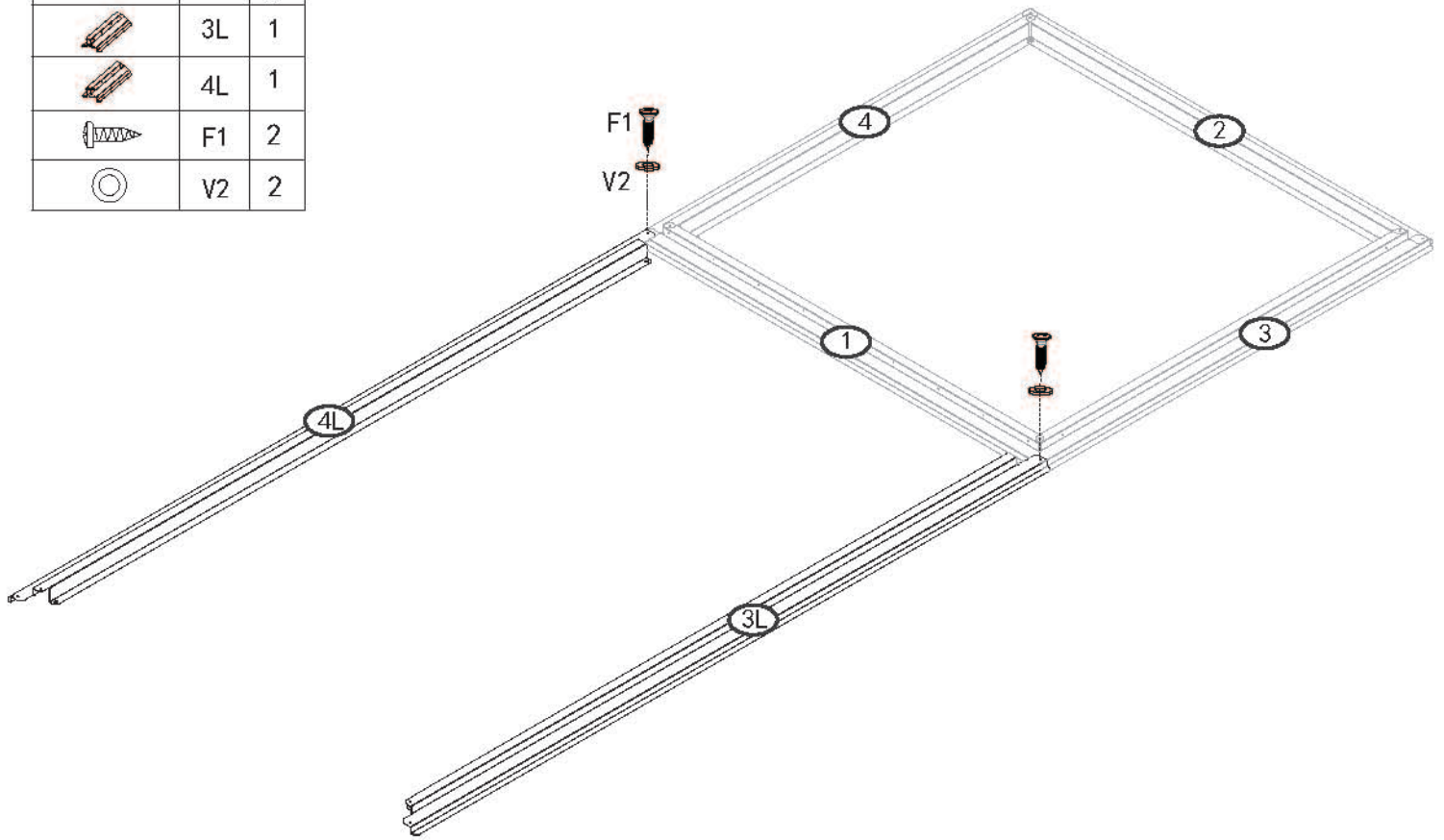

Pieces	Nr. / No.	Stk. / Qty.
	3L	1
	4L	1
	F1	2
	V2	2



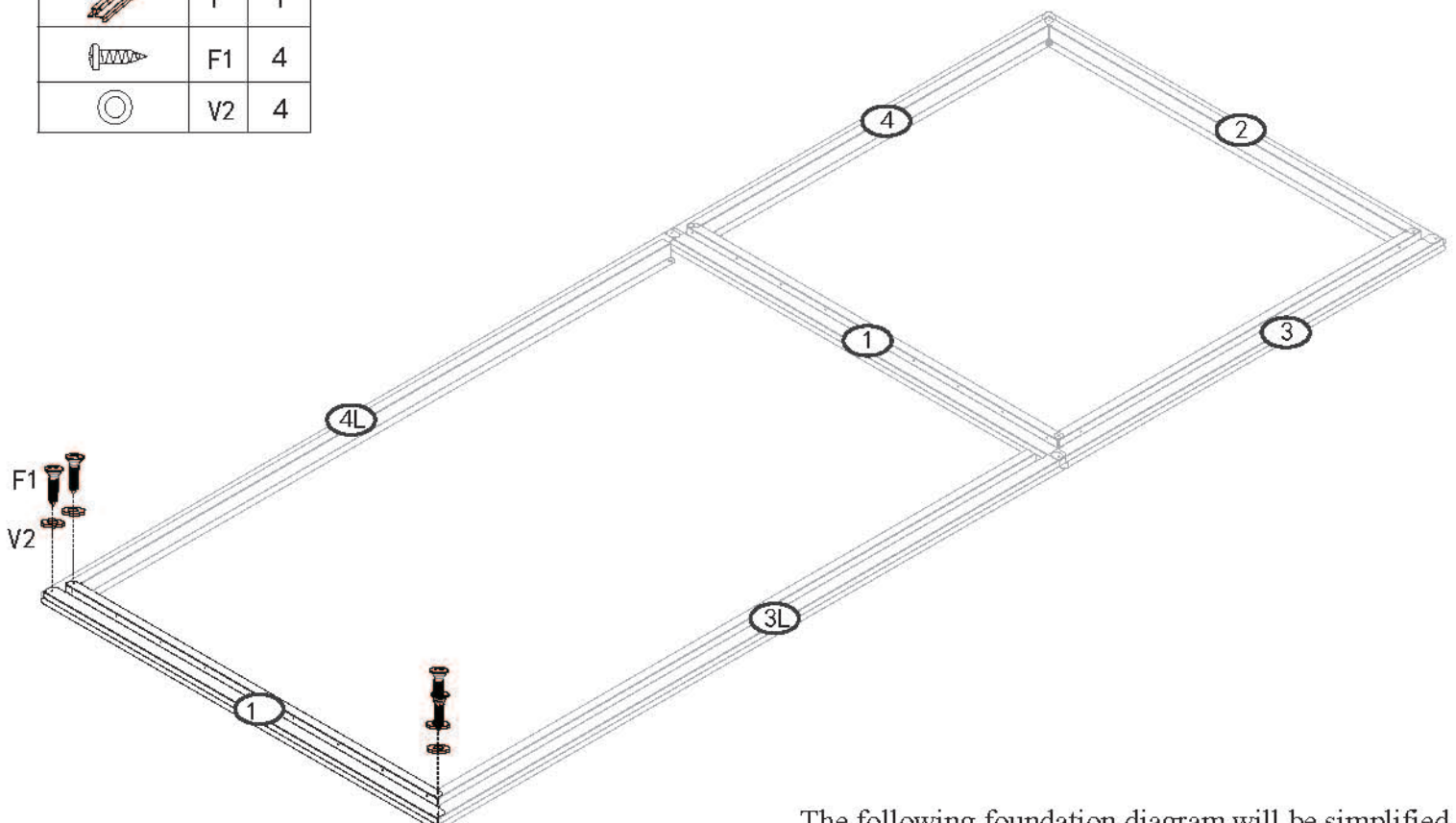



Pieces	Nr. / No.	Stk. / Qty.
	1	1
	F1	4
	V2	4



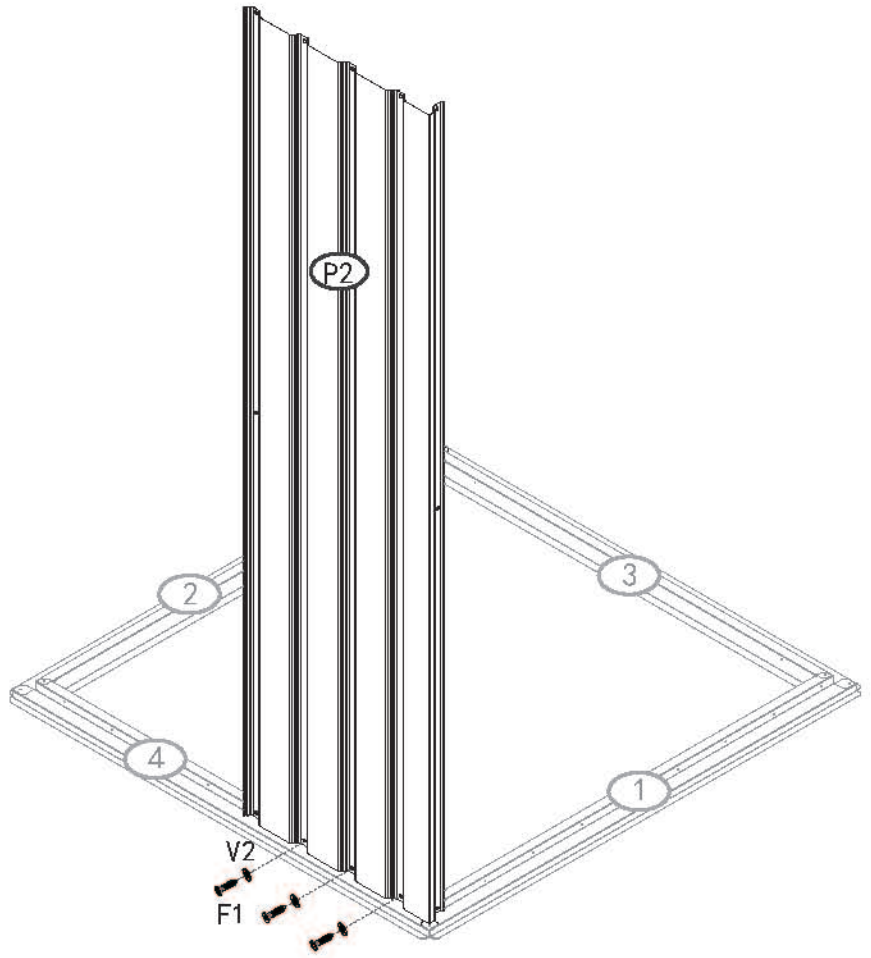



The following foundation diagram will be simplified  
 Le schéma de fondation suivant sera simplifié

Pieces	Nr./ No.	Stk./ Qty.
	P2	1
	F1	3
	V2	3

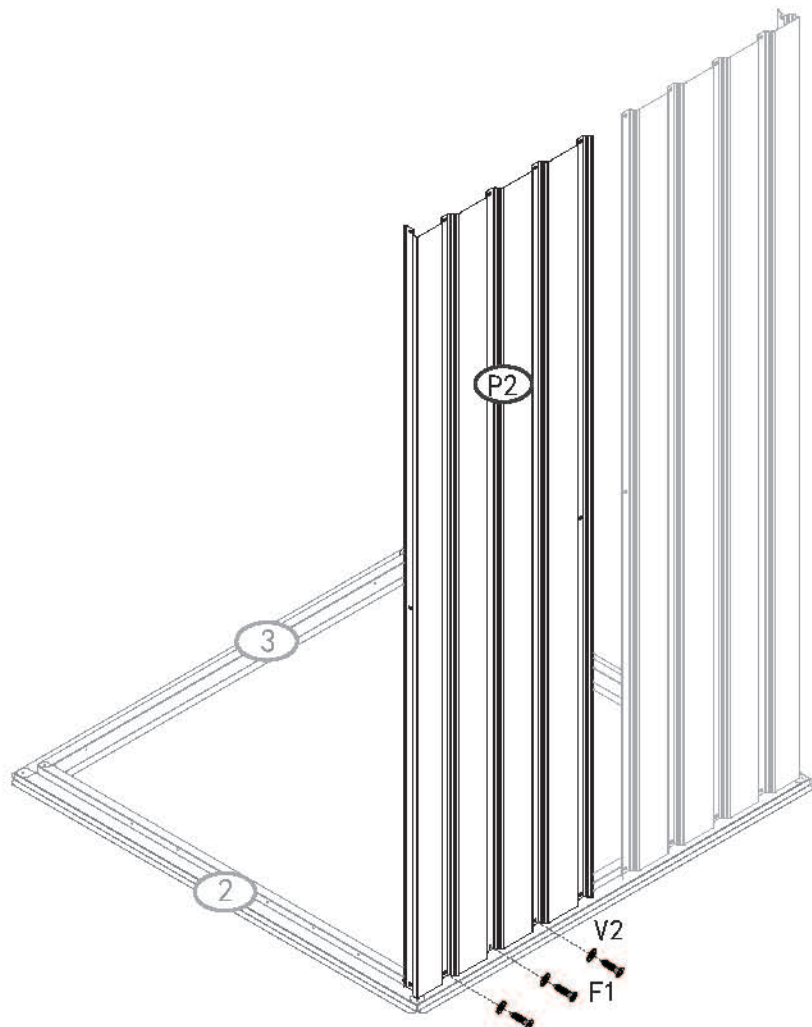





Pieces	Nr./ No.	Stk./ Qty.
	P2	1
	F1	3
	V2	3

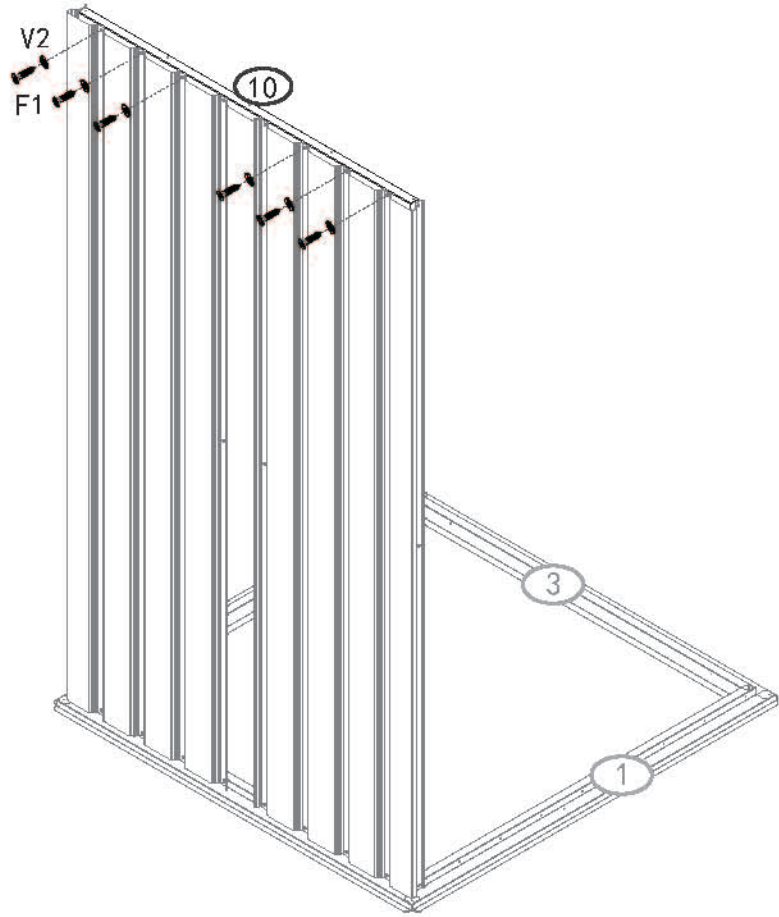



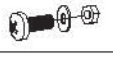

Pieces	Nr. / No.	Stk. / Qty.
	10	1
	F1	6
	V2	6







Pieces	Nr. / No.	Stk. / Qty.
	P4AL	1
	F1	4
	F2	1
	V2	4







Pieces	Nr./ No.	Stk./ Qty.
	P4AR	1
	F1	4
	F2	1
	V2	4

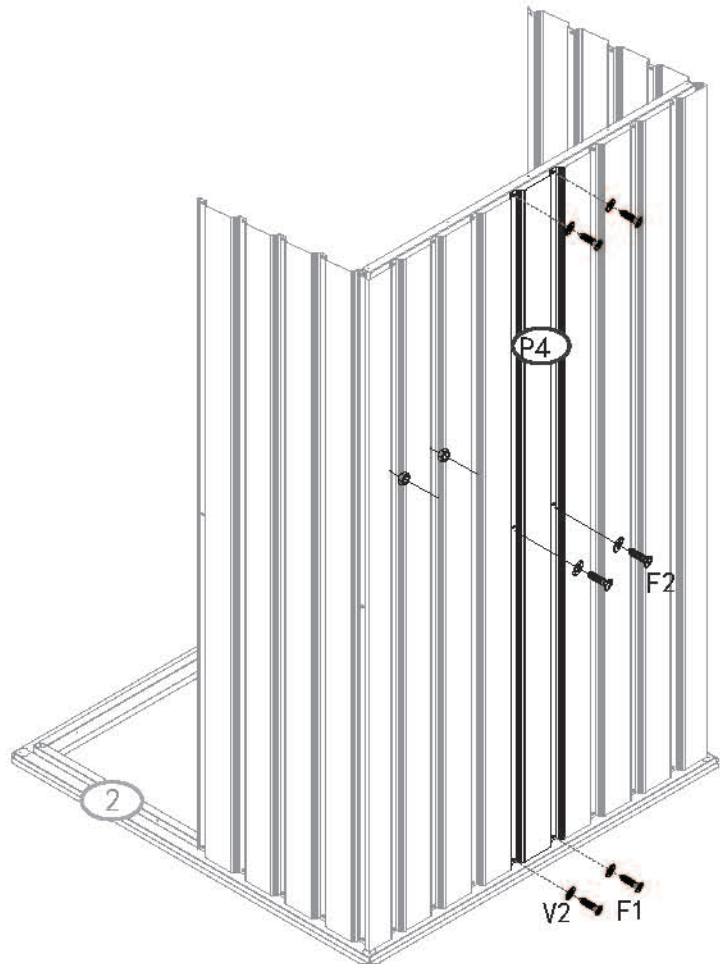





Pieces	Nr./ No.	Stk./ Qty.
	P4	1
	F1	4
	V2	4
	F2	2

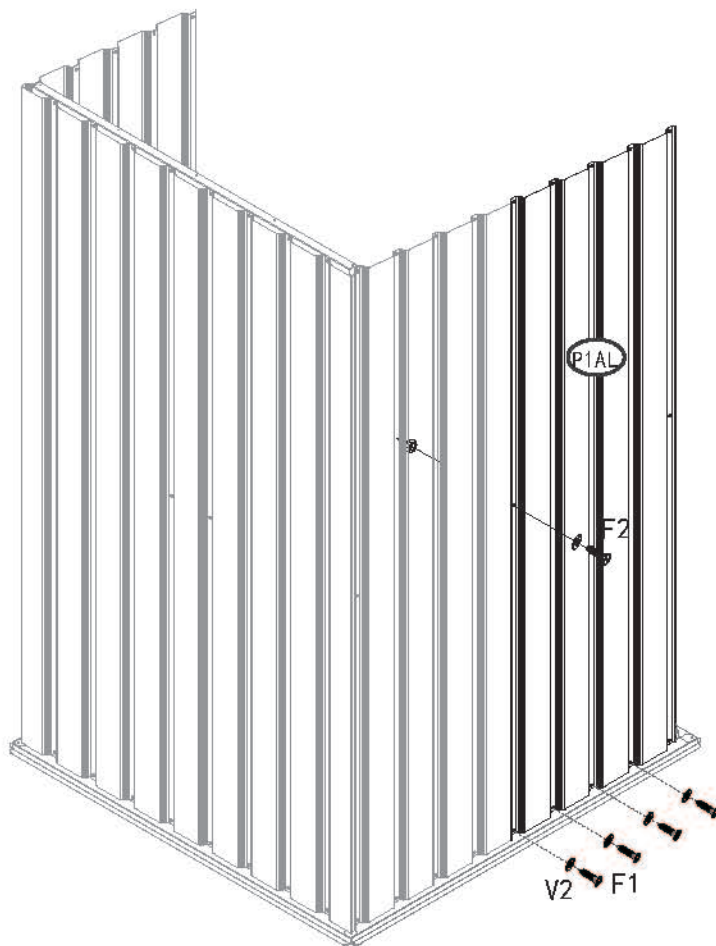





Pieces	Nr. / No.	Stk. / Qty.
	P1AL	1
	F1	4
	F2	1
	V2	4

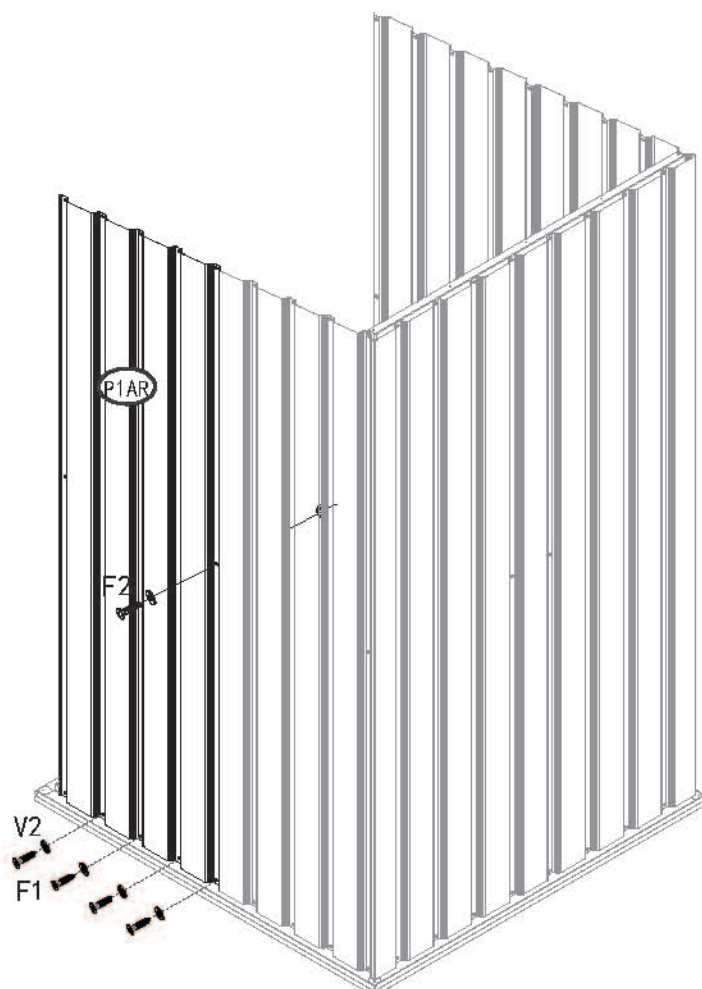



Pieces	Nr. / No.	Stk. / Qty.
	P1AR	1
	F1	4
	F2	1
	V2	4



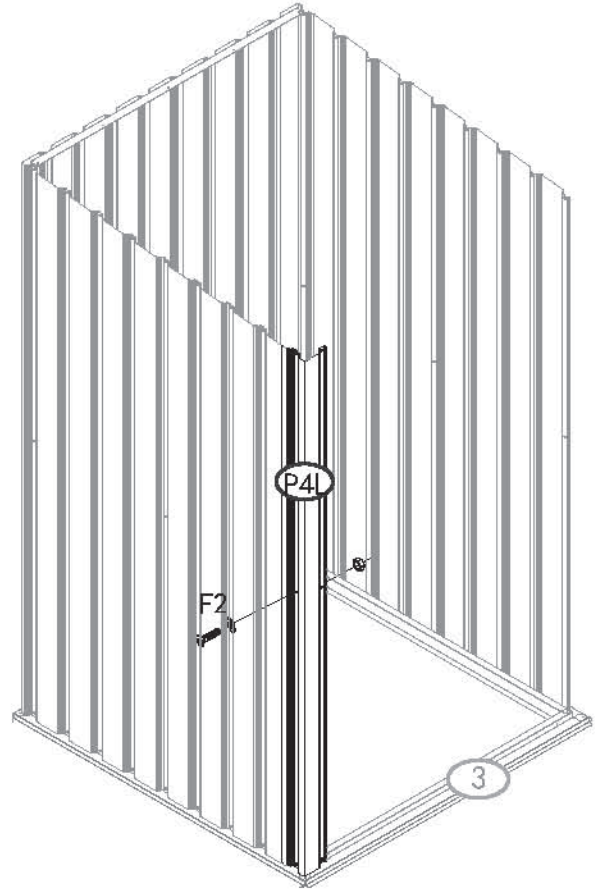

Pieces	Nr. / No.	Stk. / Qty.
	P4L	1
	F1	1
	F2	1
	V2	1



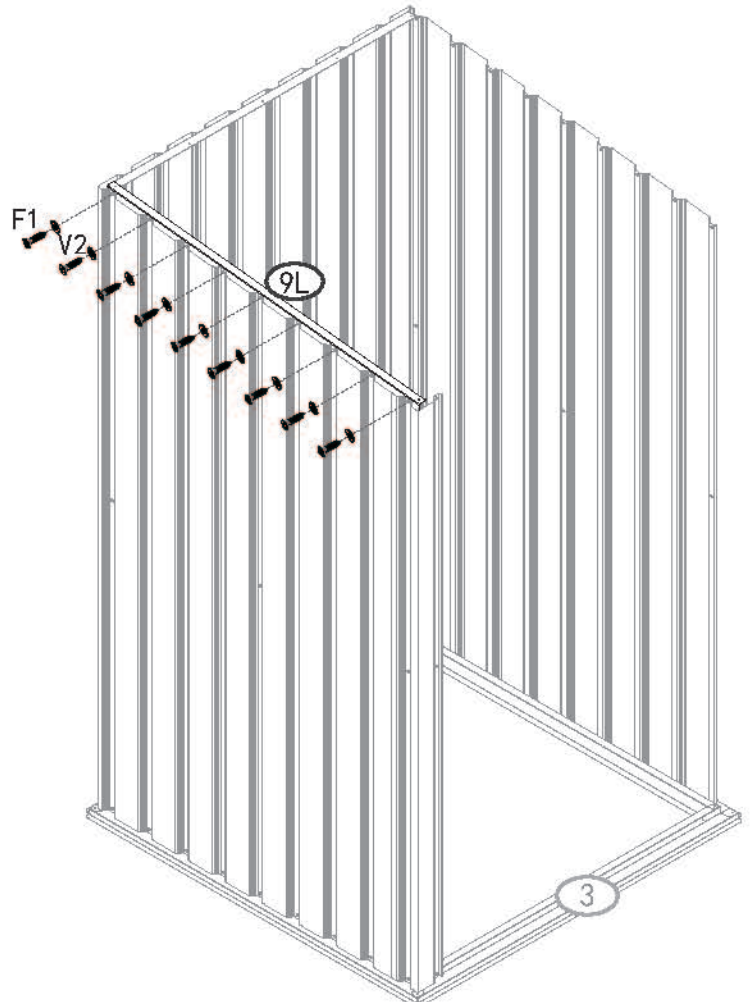



Pieces	Nr. / No.	Stk. / Qty.
	9L	1
	F1	9
	V2	9

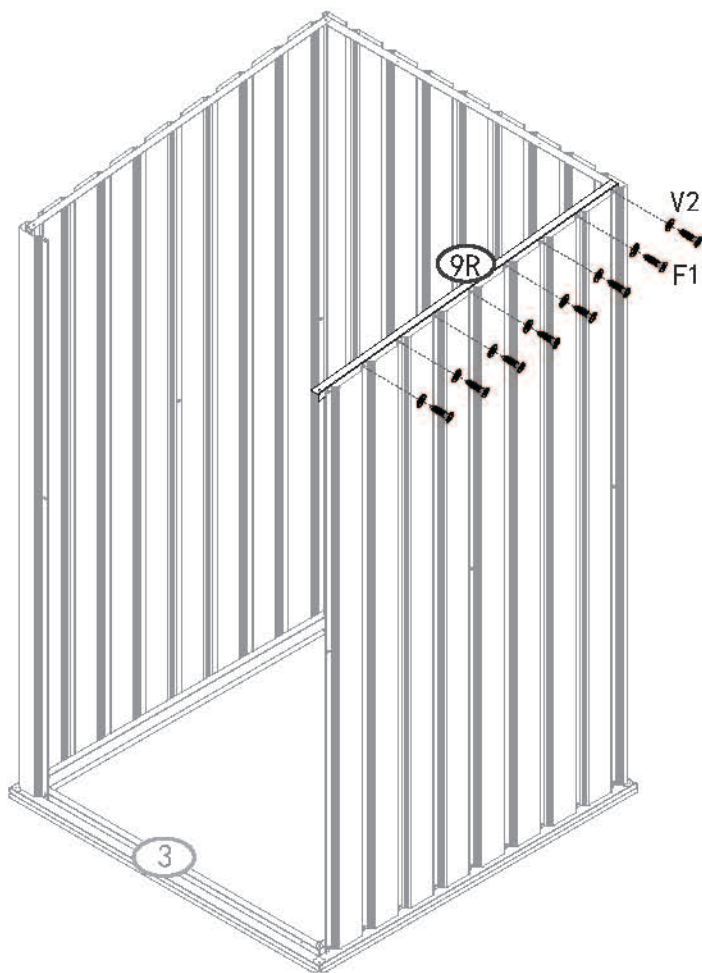





Pieces	Nr./ No.	Stk./ Qty.
	9R	1
	F1	9
	V2	9

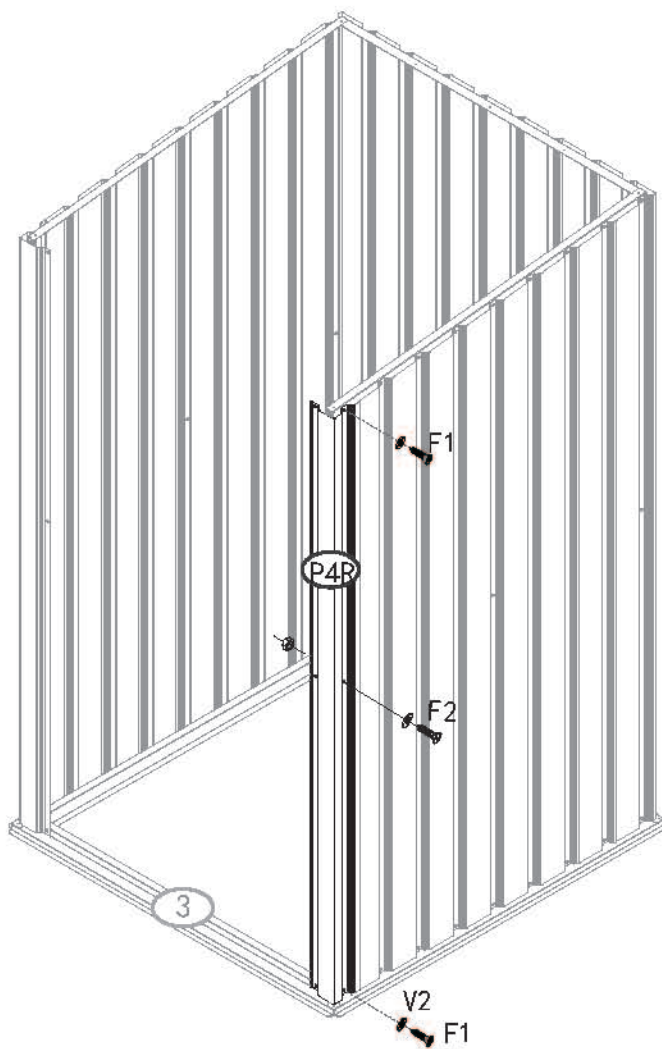



Pieces	Nr./ No.	Stk./ Qty.
	P4R	1
	F1	2
	F2	1
	V2	3



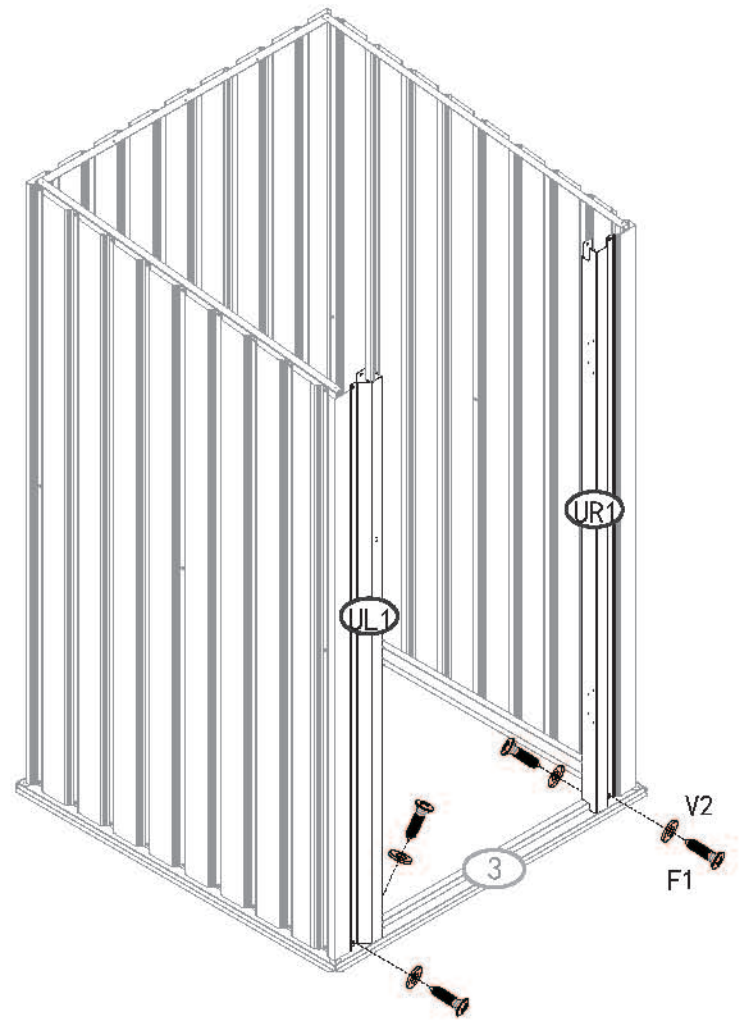





Pieces	Nr./ No.	Stk./ Qty.
	UR1	1
	UL1	1
	F1	4
	V2	4

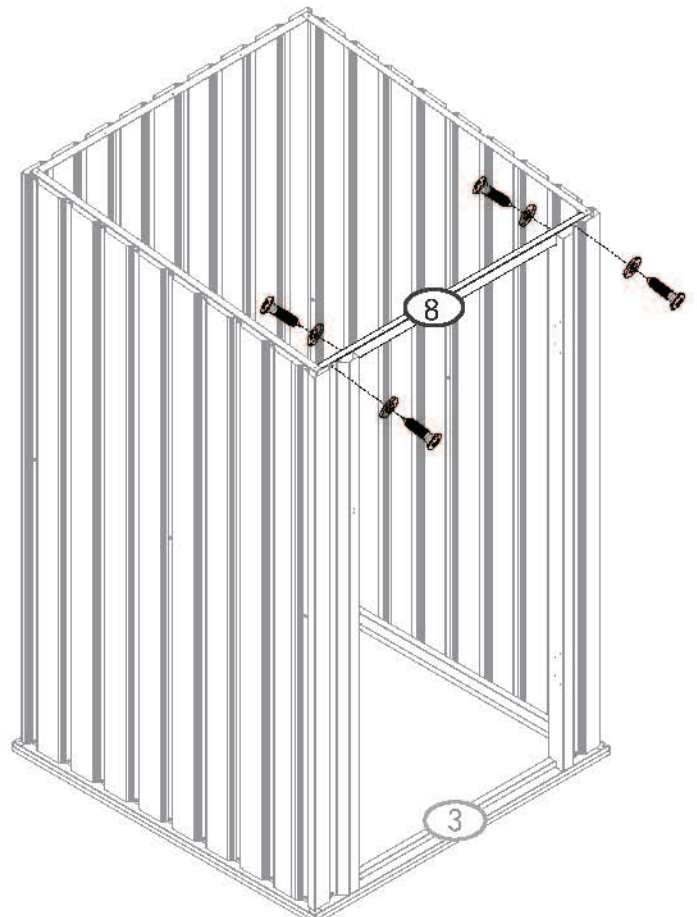





UL1 and UR1 There are holes on the inside and outside. All need to be fixed with screws  
 UL1 et UR1 Il y a des trous à l'intérieur et à l'extérieur. Tout doit être fixé avec des vis

Pieces	Nr./ No.	Stk./ Qty.
	8	1
	F1	4
	V2	4

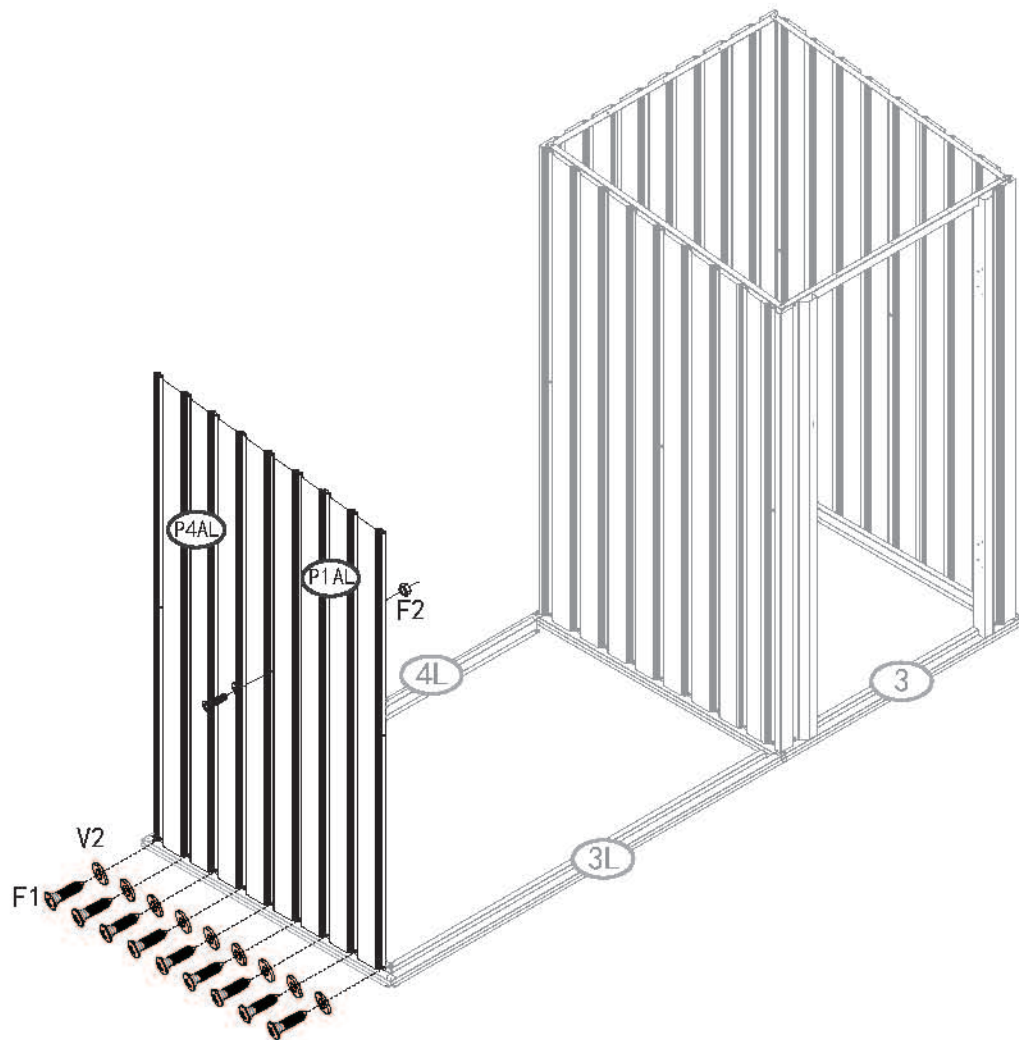





Pieces	Nr./ No.	Stk./ Qty.
	P4AL	1
	P1AL	1
	F1	9
	F2	1
	V2	10

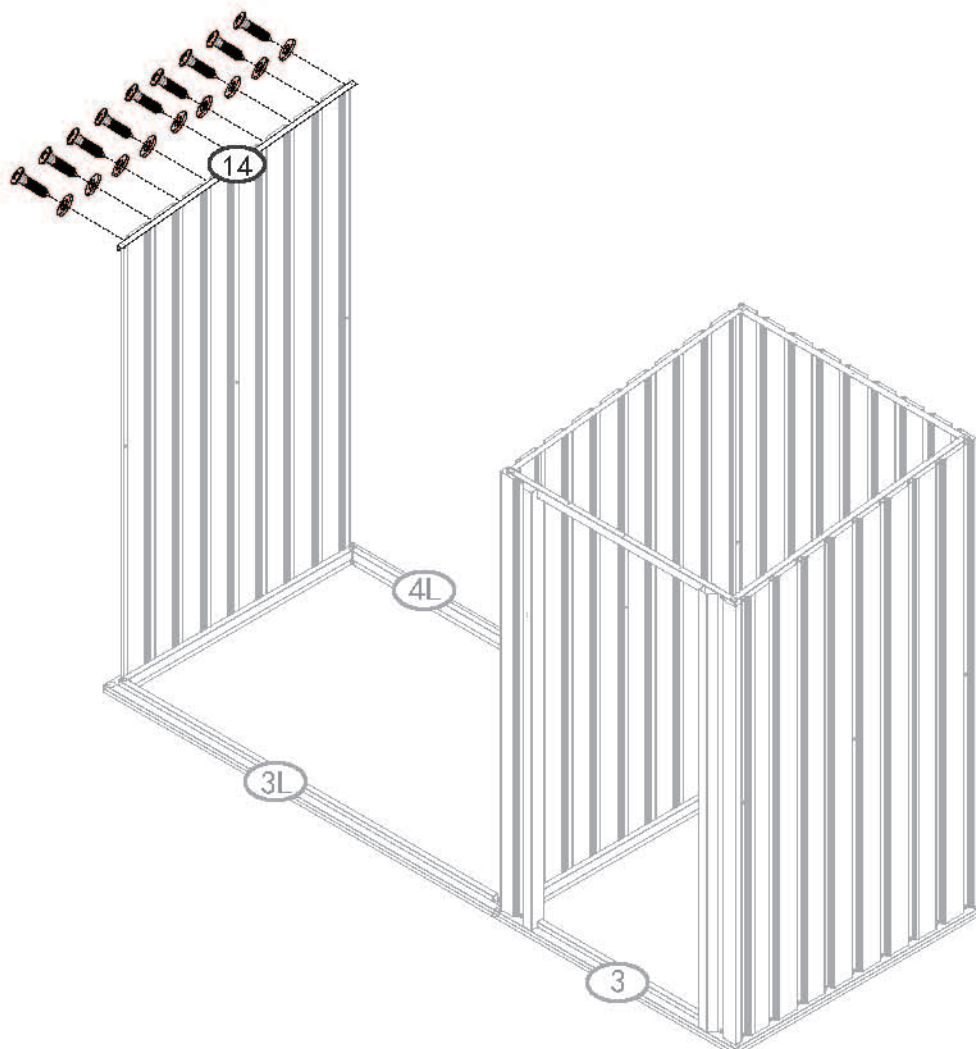



Pieces	Nr./ No.	Stk./ Qty.
	14	1
	F1	9
	V2	9



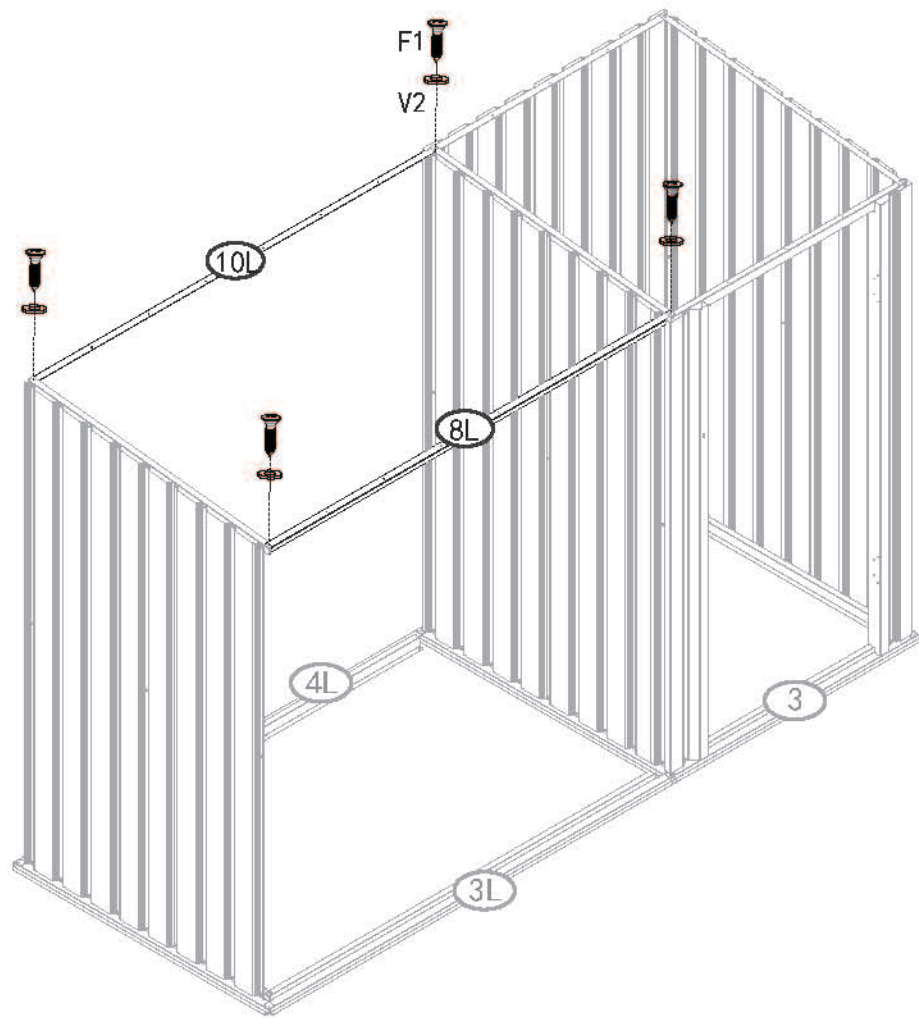



Pieces	Nr. / No.	Stk. / Qty.
	10L	1
	8L	1
	F1	4
	V2	4

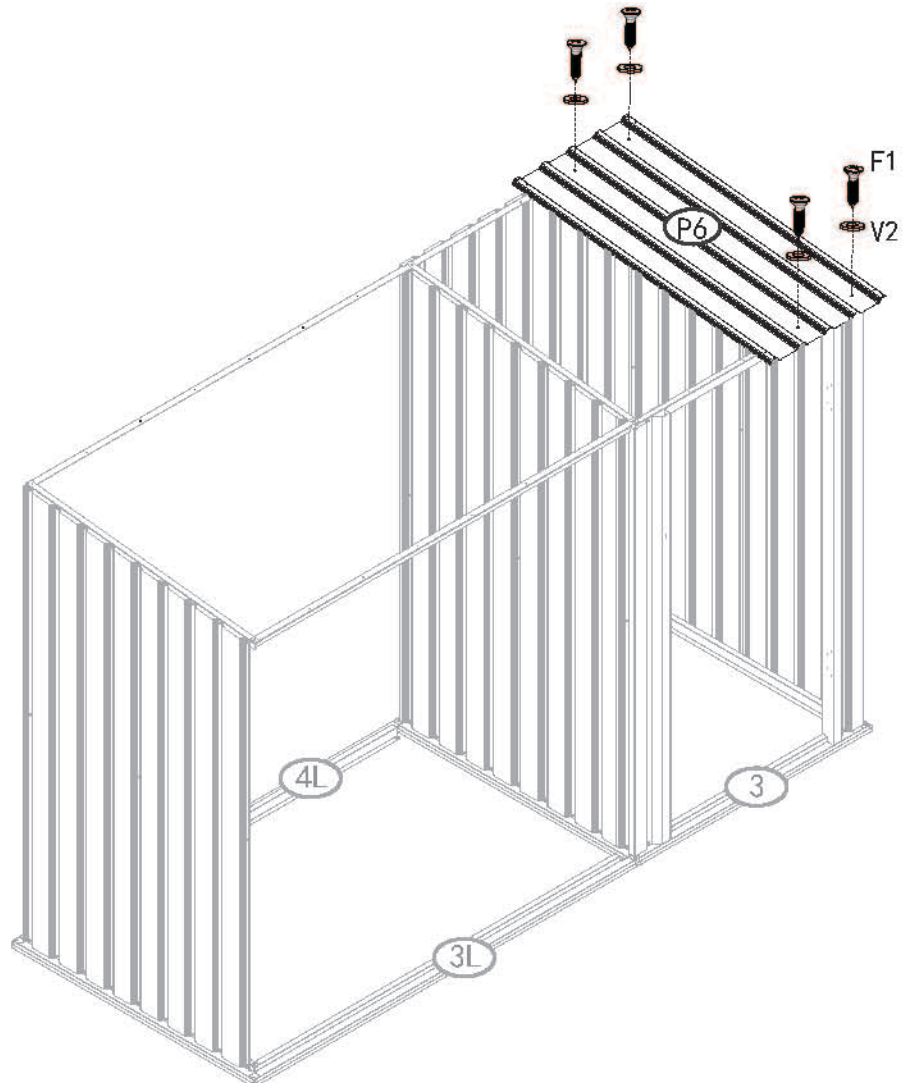



Pieces	Nr. / No.	Stk. / Qty.
	P6	1
	F1	4
	V2	4



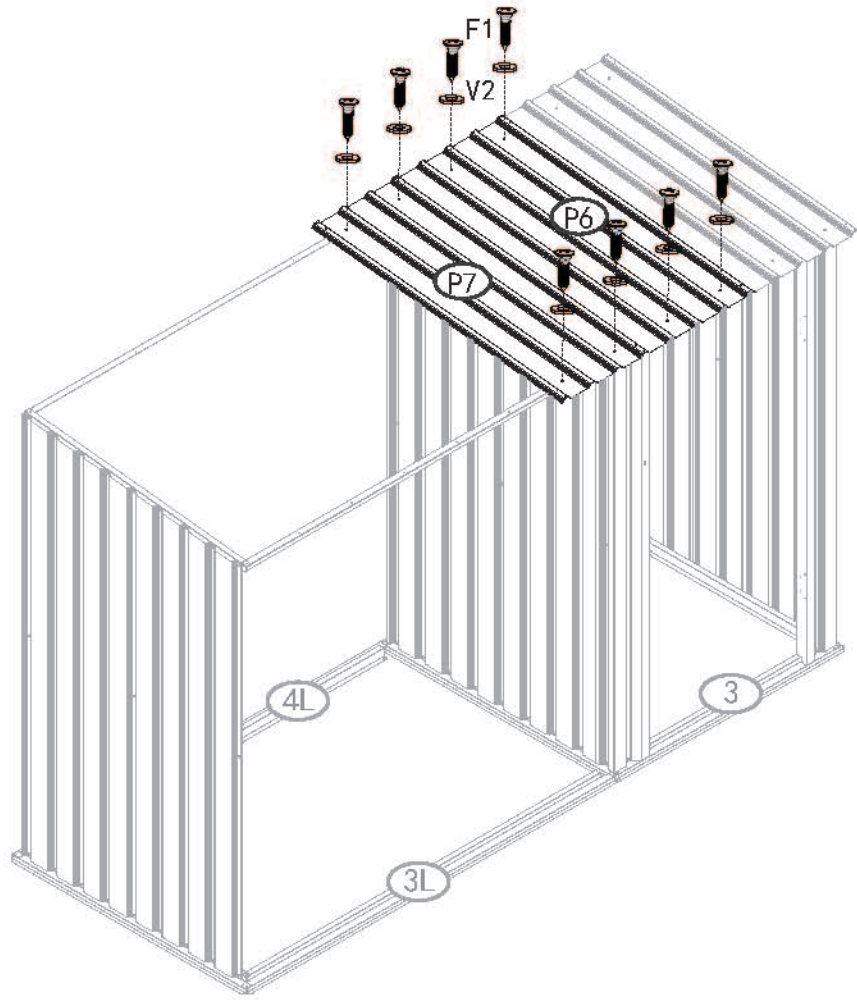





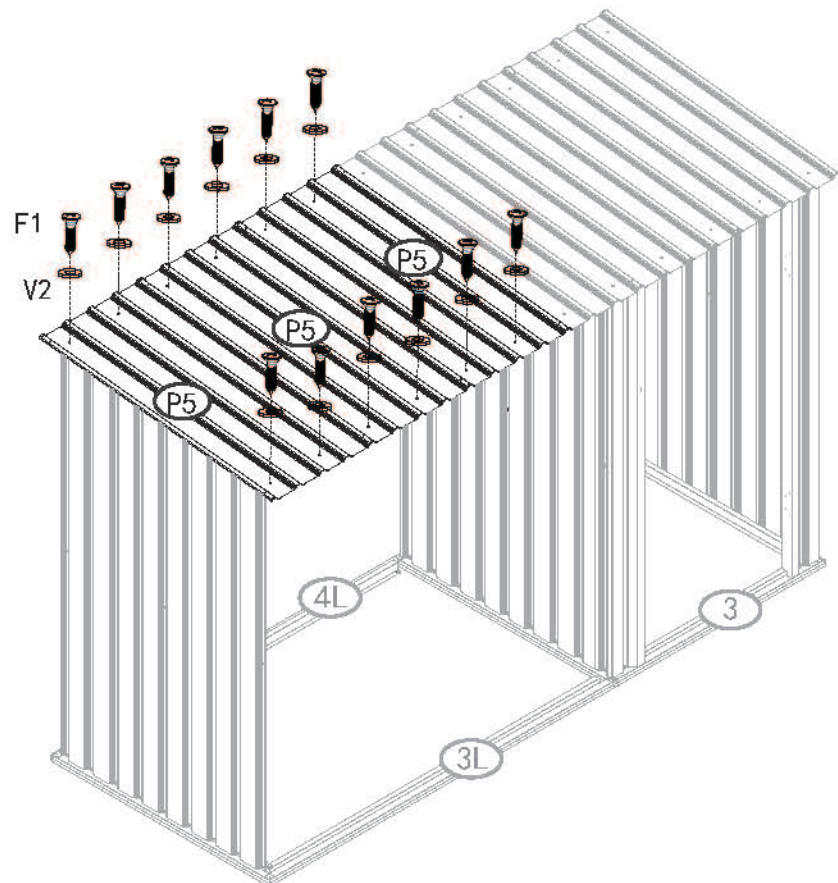

Pieces	Nr./ No.	Stk./ Qty.
	P7	1
	P6	1
	F1	8
	V2	8



Pieces	Nr./ No.	Stk./ Qty.
	P5	3
	F1	12
	V2	12



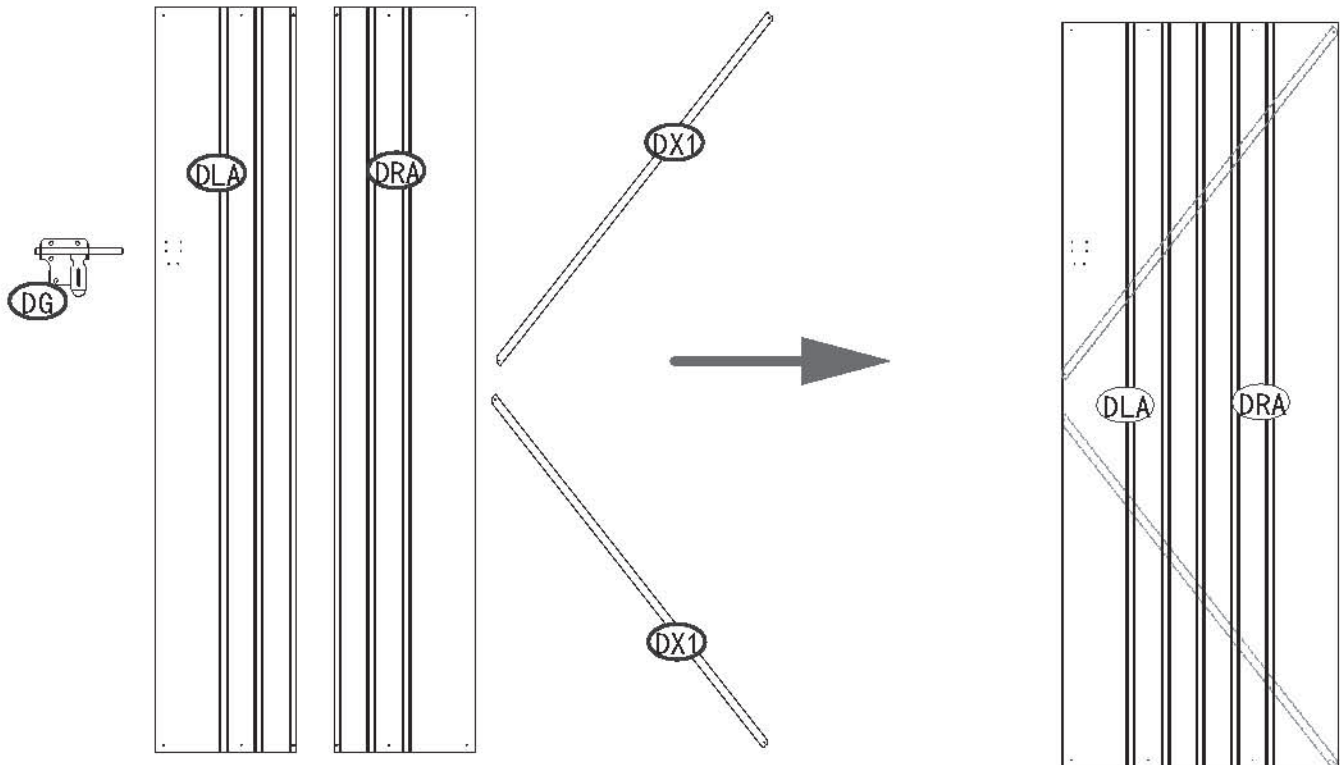
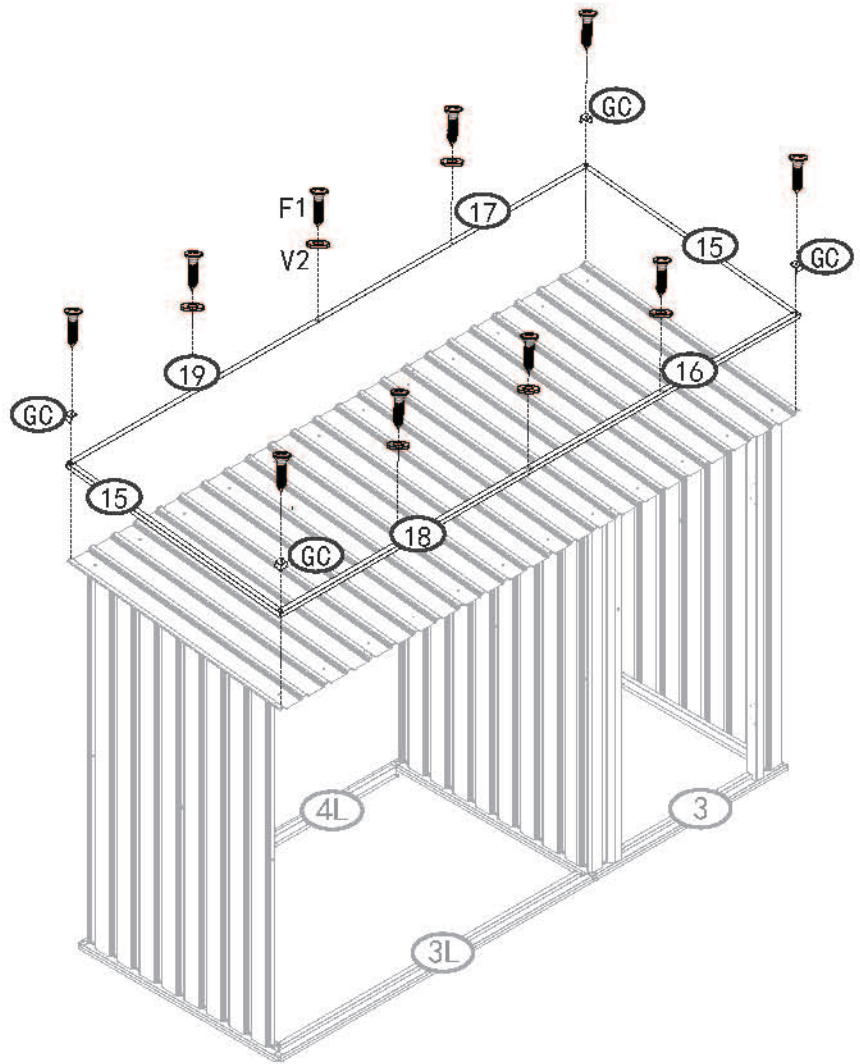

Pieces	Nr. / No.	Stk. / Qty.
	15	2
	16	1
	17	1
	18	1
	19	1
	GC	4
	F1	10
	V2	6

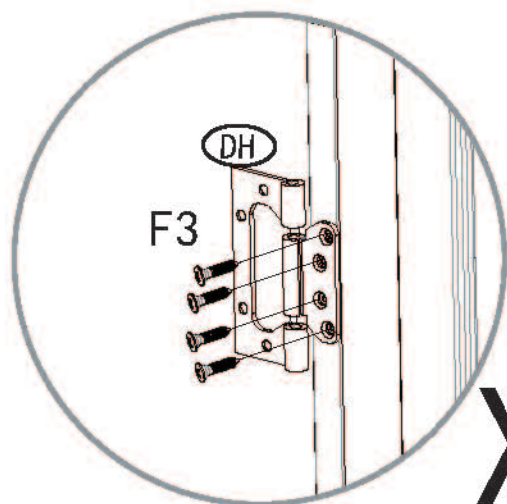
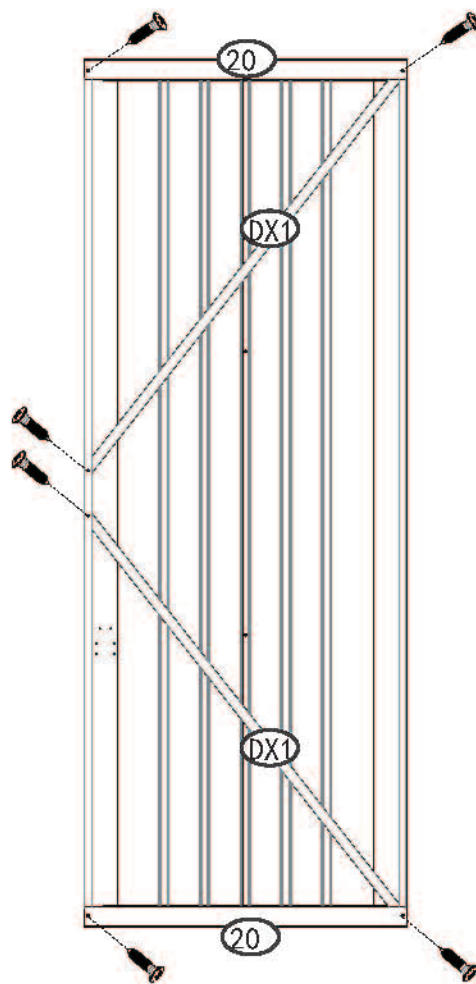
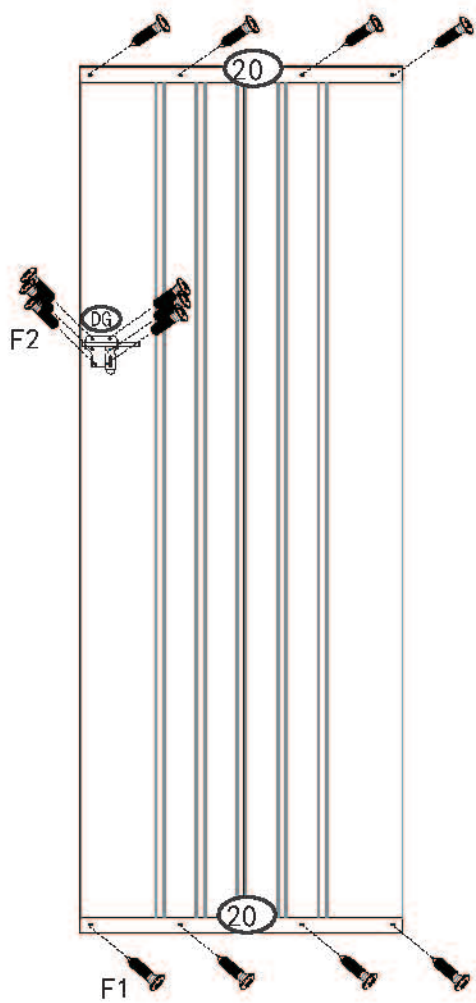



X2



Pieces	Nr./ No.	Stk./ Qty.
	DH	2
	F3	8

