

ASSEMBLY INSTRUCTION

INSTRUCTION DE MONTAGE

This set includes 2 boxes if don't receive full 2 boxes please contact our customer service team
Cet ensemble comprend 2 boîtes. Si vous ne recevez pas les 2 boîtes complètes, veuillez contacter notre service client.

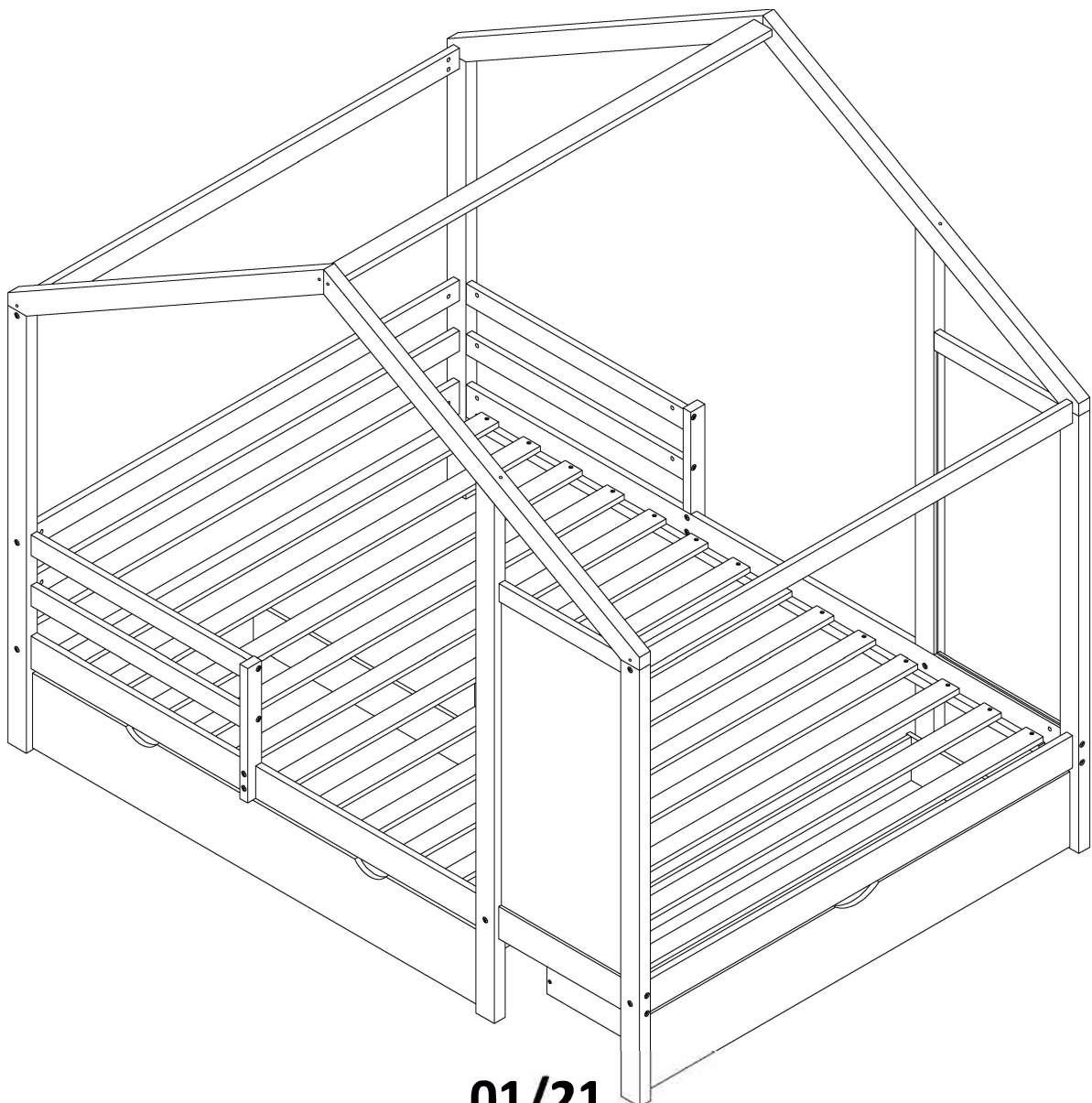



IMPORTANT NOTICE

Size of Mattress and Foundation

This bed is designed to use only mattress(es) meeting the following specifications on the lower bunk:

Lower bed

Bed type Twin size **Length** 74"-75" **Width** 38½" **Thickness** 8" max

Replacement Parts

Replacement parts, including additional guardrails, may be obtained from any of our dealers

ENGLISH

SAFETY WARNINGS

1. Follow the information on the warnings appearing on the upper bunk bed end structure and on the carton. Do not remove warning label from bed.
2. Always use recommended size mattress or mattress support, or both, to help prevent the likelihood of entrapment or falls.
3. Surface of mattress must be at least 5" (127mm) below the upper edge of the guardrails.
4. Do not allow children under 6 years of age to use the upper bunk.
5. Periodically check and ensure that the guardrail, ladder and other components are in their proper position, free from damage and that the connectors are tight.
6. Do not allow horseplay on or under the bed and prohibit jumping on the bed.
7. Prohibit more than one person on the upper bunk.
8. Always use the ladder for entering and leaving the upper bunk.
9. Do not use substitute parts. Contact customer service team for replacement parts.
10. Use of a night light may provide added safety precaution for a child using the upper bunk.
11. Always use guardrails on both long sides of upper bunk.
12. If the bunk bed will be placed next to a wall, the guardrail that runs the full length of the bed should be placed against the wall to prevent entrapment between the bed and the wall.
13. The use of water or sleep flotation mattresses is prohibited.
14. Keep these instructions for future reference.

STRANGULATION HAZARD

15. Never attach or hang items to any part of the bunk bed that are not designed for use with the bed, for example but not limited to hooks, belts, and jump ropes.

Français

AVERTISSEMENTS DE SÉCURITÉ

1. suivez les informations sur les avertissements figurant sur la structure d'extrémité du lit superposé supérieur et sur le carton d'emballage. Ne retirez pas l'étiquette d'avertissement du lit.
2. Utilisez toujours un matelas ou un support de matelas de la taille recommandée, ou les deux, pour éviter tout risque de coincement ou de chute.
3. La surface du matelas doit être au moins 5" (127 mm) en dessous du bord supérieur des garde-corps.
4. ne pas permettre aux enfants de moins de 6 ans d'utiliser la couchette supérieure.
5. vérifier périodiquement que le garde-corps, l'échelle et les autres éléments sont bien positionnés, qu'ils ne sont pas endommagés et que les connecteurs sont bien serrés.
6. ne pas permettre le chahut sur ou sous le lit et interdire de sauter sur le lit.
7. il est interdit d'installer plus d'une personne sur la couchette supérieure.
8. toujours utiliser l'échelle pour entrer et sortir de la couchette supérieure.
9. Ne pas utiliser de substitut. Contactez le service clientèle pour obtenir des pièces de rechange.
10. l'utilisation d'une veilleuse peut constituer une précaution supplémentaire pour un enfant qui utilise la couchette supérieure.
11. toujours utiliser les garde-corps sur les deux côtés de la couchette supérieure.
12. Si le lit superposé est placé à côté d'un mur, le garde-corps qui court sur toute la longueur du lit doit être placé contre le mur afin d'éviter tout risque de coincement entre le lit et le mur.
13. L'utilisation de matelas à eau ou de matelas de flottaison est interdite.
14. conservez-les pour référence ultérieure.

RISQUE DE STRANGULATION

Ne jamais attacher ou suspendre à une partie du lit superposé des objets qui ne sont pas conçus pour être utilisés avec le lit, par exemple, mais sans s'y limiter, des crochets, des ceintures et des cordes à sauter.

Española

ADVERTENCIAS DE SEGURIDAD

1. Siga la información de las advertencias que aparecen en la estructura del extremo de la litera superior y en la caja. No retire la etiqueta de advertencia de la cama.
2. Utilice siempre un colchón del tamaño recomendado o un soporte de colchón, o ambos, para ayudar a prevenir la probabilidad de atrapamiento o caídas.
3. La superficie del colchón debe estar al menos 5" (127mm) por debajo del borde superior de las barandillas.
4. No permita que niños menores de 6 años utilicen la litera superior.
5. Compruebe y asegúrese periódicamente de que la barandilla, la escalera y otros componentes están en su posición correcta, libres de daños y que los conectores están bien apretados.
6. No permita juegos bruscos sobre o debajo de la cama y prohíba saltar sobre la cama.
7. Prohíba que haya más de una persona en la litera superior.
8. Utilice siempre la escalera para entrar y salir de la litera superior.
9. No utilice piezas de repuesto. Consulte al distribuidor para obtener piezas de repuesto.
10. El uso de una luz nocturna puede proporcionar una mayor precaución de seguridad para un niño que utilice la litera superior.
11. Utilice siempre barandillas en ambos lados largos de la litera superior.
12. Si la litera se coloca junto a una pared, la barandilla que recorre toda la longitud de la cama debe colocarse contra la pared para evitar que el niño quede atrapado entre la cama y la pared.
13. Queda prohibido el uso de colchones de flotación de agua o de sueño.
14. Guarde estas instrucciones como referencia futura

PELIGRO DE ESTRANGULAMIENTO

Nunca fije o cuelgue objetos en ninguna parte de la litera que no estén diseñados para su uso con la cama, por ejemplo, pero sin limitarse a, ganchos, cinturones y cuerdas de saltar.

English

IMPORTANT ! KEEP FOR FUTURE REFERENCE : READ CAREFULLY

- To be assembled by an adult. Assembly must be checked by an adult before use
- **WARNING !** Keep all screws, small parts and plastic bags out of the reach of children
- Properly identify all parts before assembling
- Never use your item if any of its parts are broken or missing
- Should any problems arise, please contact our After Sales Service
- Manufacturer's instructions shall be followed at all times
- Care: clean with a soft, dry cloth. In case of larger stains, carefully rub with a slightly damp, non-abrasive sponge
- Do not jump on the bed

Français

IMPORTANT ! CONSERVER POUR RÉFÉRENCE ULTÉRIEURE : LIRE ATTENTIVEMENT

- To be assembled by an adult. Assembly must be checked by an adult before use
- **WARNING !** Keep all screws, small parts and plastic bags out of the reach of children
- Properly identify all parts before assembling
- Never use your item if any of its parts are broken or missing
- Should any problems arise, please contact our After Sales Service
- Manufacturer's instructions shall be followed at all times
- Care: clean with a soft, dry cloth. In case of larger stains, carefully rub with a slightly damp, non-abrasive sponge
- Do not jump on the bed

Español

IMPORTANTE CONSÉRVELO PARA FUTURAS CONSULTAS: LEA ATENTAMENTE

- Debe ser montado por un adulto. El montaje debe ser comprobado por un adulto antes del uso
- **ADVERTENCIA** Mantenga todos los tornillos, piezas pequeñas y bolsas de plástico fuera del alcance de los niños.
- Identifique correctamente todas las piezas antes de montarlas
- Nunca utilice su artículo si alguna de sus piezas está rota o falta
- Si surge algún problema, póngase en contacto con nuestro Servicio Postventa
- Las instrucciones del fabricante deben seguirse en todo momento
- Cuidado: limpiar con un paño suave y seco. En caso de manchas más grandes, frotar cuidadosamente con una esponja no abrasiva ligeramente húmeda.
- No saltar sobre la cama

More Tips

1

English - Before installation, you can place the parts on a carpet or other soft fabric, in order to avoid damaging your floor.

Français - Avant l'installation, vous pouvez placer les pièces sur un tapis ou un autre tissu doux, afin d'éviter d'endommager votre sol.

Español - Antes de la instalación, puede colocar las piezas sobre una alfombra u otro tejido suave para no dañar el suelo.

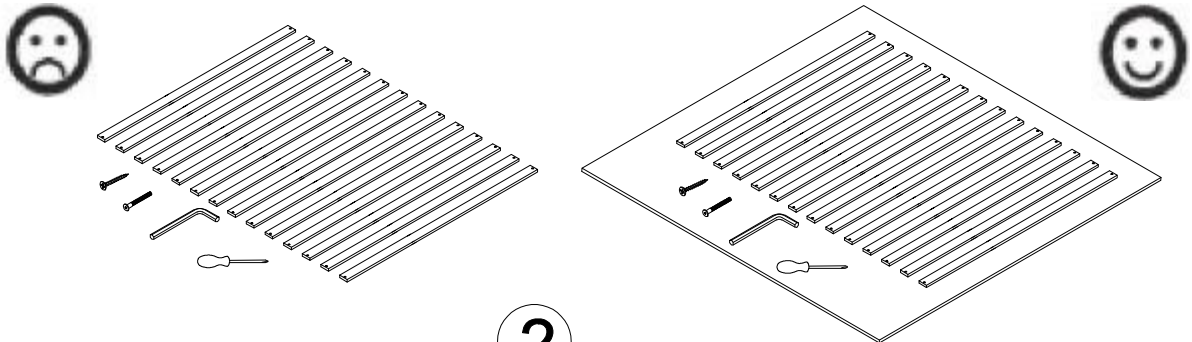

2

English - For your and your family's safety, please do not jump on beds, especially with hydraulic structures. When need to move bed, please work with more than one person to lift, not push, to avoid scratching your floor and hurting the stability of the bed.

Français - Pour votre sécurité et celle de votre famille, ne sautez pas sur les lits, en particulier sur les structures hydrauliques. Lorsqu'il est nécessaire de déplacer le lit, il est préférable de travailler à plusieurs pour le soulever, et non pour le pousser, afin d'éviter de rayer le sol et de nuire à la stabilité du lit.

Español - Para su seguridad y la de su familia, por favor no salte sobre las camas, especialmente con estructuras hidráulicas. Cuando tenga que mover la cama, por favor, trabaje con más de una persona para levantar, no empujar, para evitar rayar su piso y dañar la estabilidad de la cama.



OPTION 1:BLACKBOARD IN FRONT

OPTION 1 : TABLEAU NOIR DEVANT

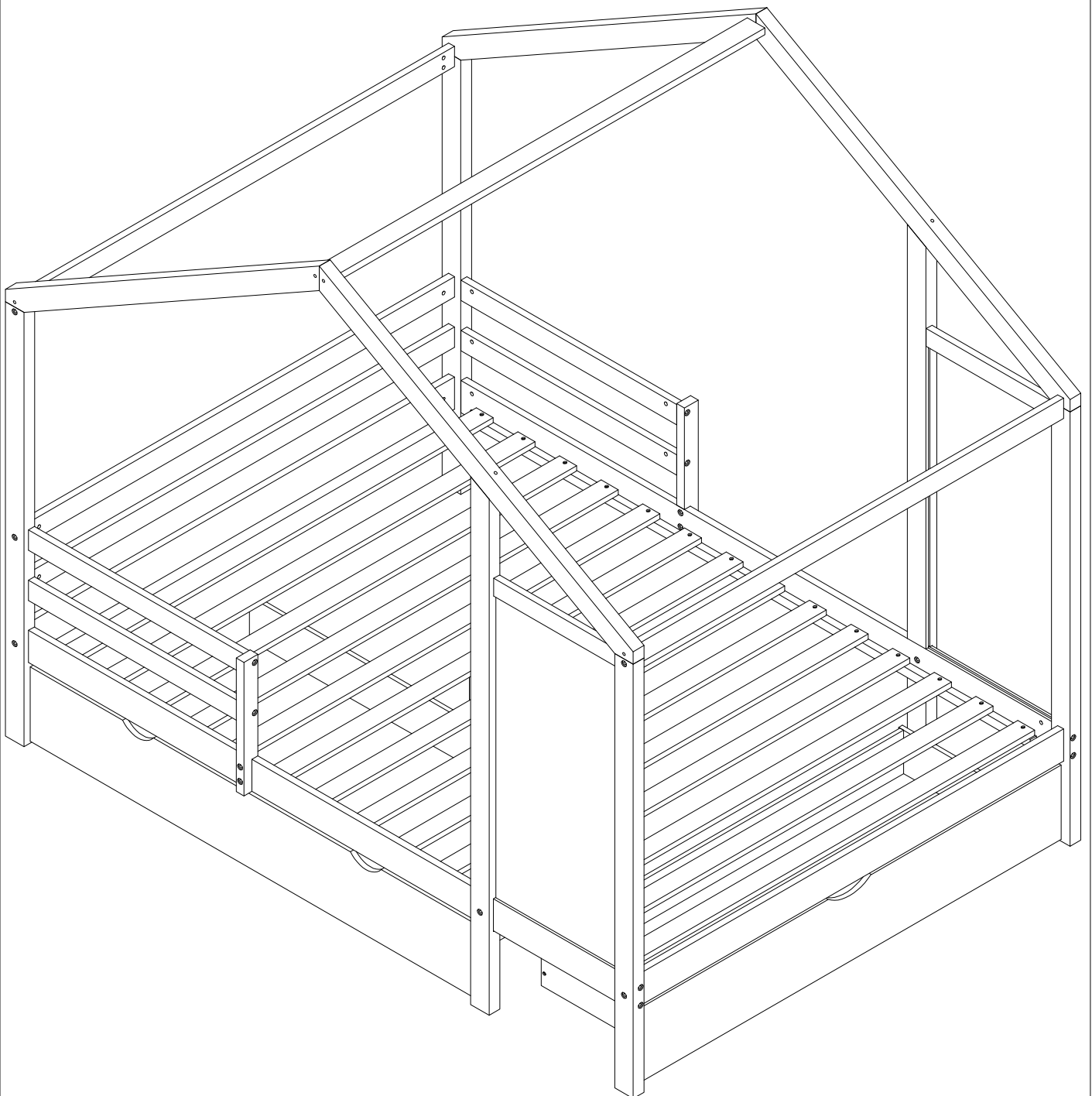

05/21

OPTION 2:BLACKBOARD IN BACK
OPTION 2 : TABLEAU NOIR À L'ARRIÈRE

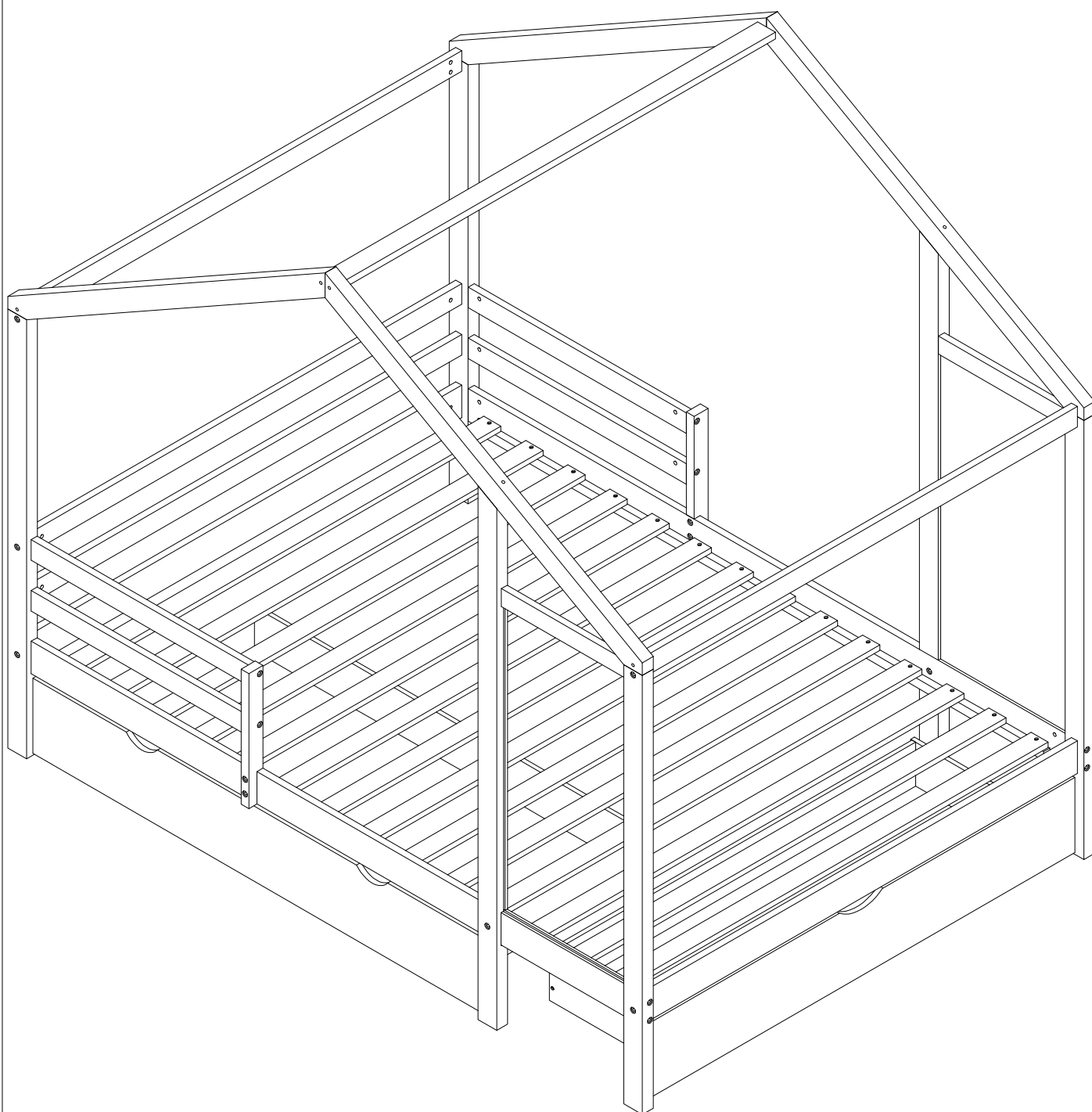





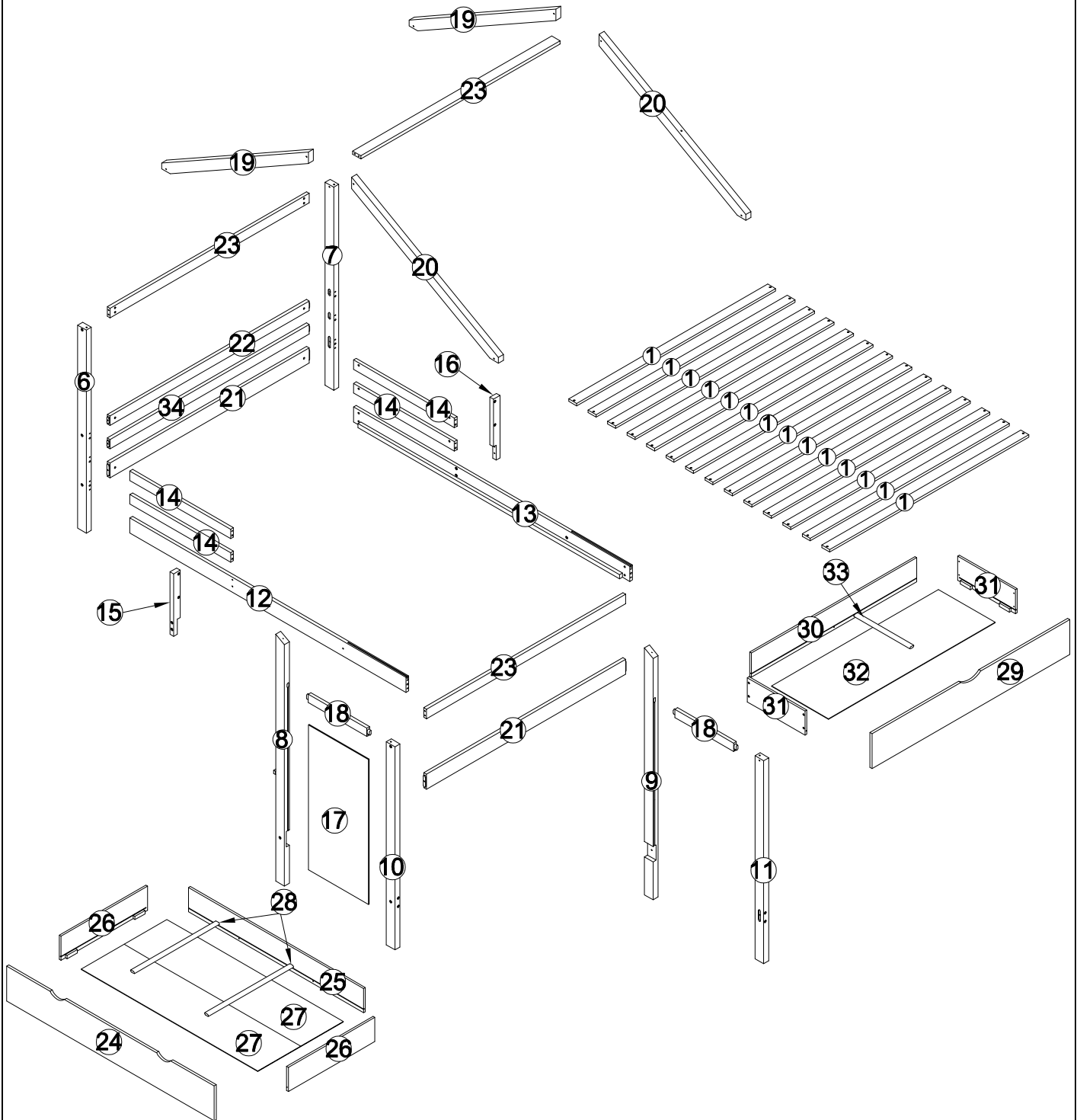



Components List

Liste des composants

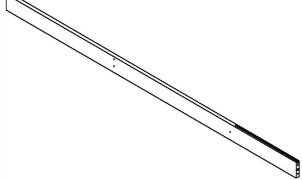
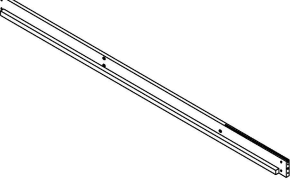
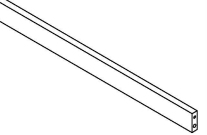

Part List & Hardware List

Liste des pièces et liste du matériel

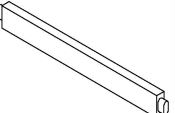
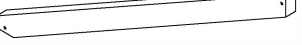
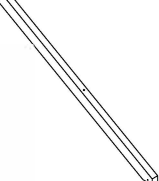
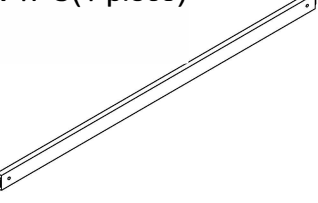
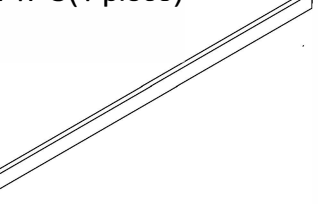
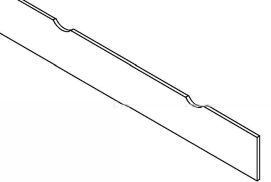
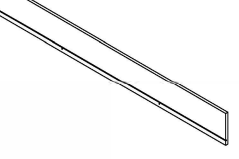
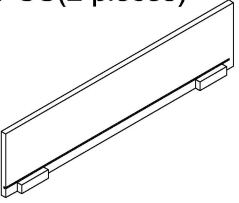
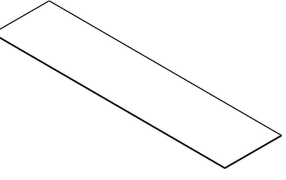
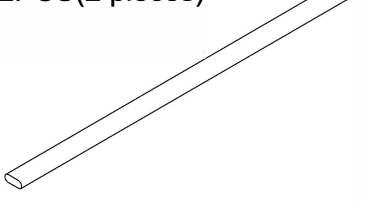
6 x 1PC(1 pièce) 	7 x 1PC(1 pièce) 	8 x 1PC(1 pièce) 
9 x 1PC(1 pièce) 	10 x 1PC(1 pièce) 	11 x 1PC(1 pièce) 
12 x 1PC(1 pièce) 	13 x 1PC(1 pièce) 	14 x 4PCS(4 pièces) 
15 x 1PC(1 pièce) 	16 x 1PC(1 pièce) 	18 x 2PCS(2 pièces) 
19 x 2PCS(2 pièces) 	20 x 2PCS(2 pièces) 	22 x 1PC(1 pièce) 
34 x 1PC(1 pièce) 	24 x 1PC(1 pièce) 	25 x 1PC(1 pièce) 
26 x 2PCS(2 pièces) 	27 x 2PCS(2 pièces) 	28 x 2PCS(2 pièces) 

Part List & Hardware List

Liste des pièces et liste du matériel

31 x 2PCS(2 pièces)

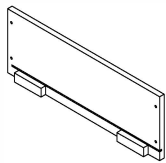

33 x 1PC(1 pièce)

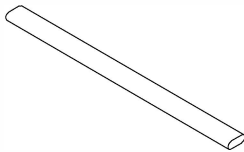

Part List

Liste des pièces

1 x 14PCS(14 pièces)

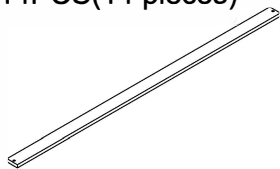

17 x 1PC(1 pièce)



21 x 2PCS(2 pièces)

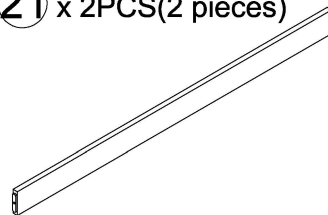

23 x 3PCS(3 pièces)

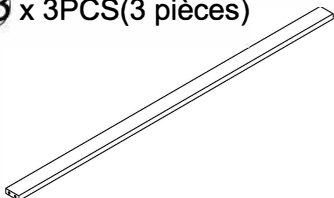

29 x 1PC(1 pièce)

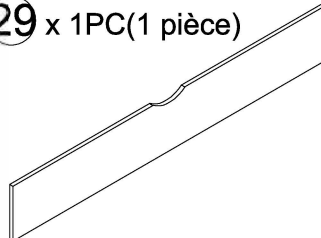

30 x 1PC(1 pièce)

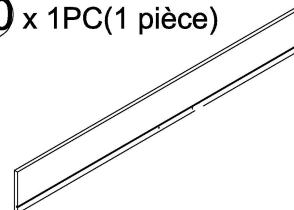



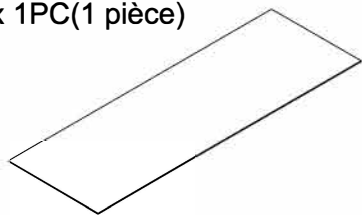





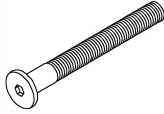

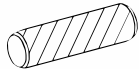

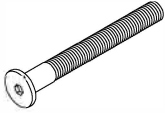
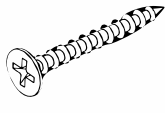
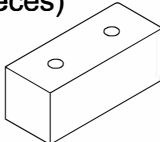
32 x 1PC(1 pièce)

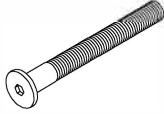
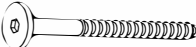

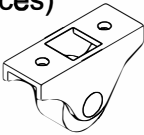

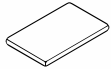
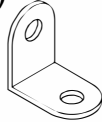
Hardware List

Liste du matériel

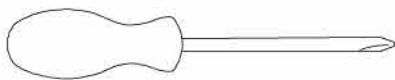

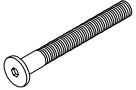

<p>A x 18PCS(18 pièces)</p>  <p style="text-align: center;">Ø6 x 80 mm</p>	<p>B x 34PCS(34 pièces)</p>  <p style="text-align: center;">Ø6 x 13 mm</p>	<p>C x 16PCS(16 pièces)</p>  <p style="text-align: center;">Wood dowel Ø10 x 40 mm Cheville à bois Ø10 x 40 mm</p>
<p>D x 12PCS(12 pièces)</p>  <p style="text-align: center;">Ø6 x 100 mm</p>	<p>E x 6PCS(6 pièces)</p>  <p style="text-align: center;">Ø6 x 15 mm</p>	<p>F x 4PCS(4 pièces)</p>  <p style="text-align: center;">Ø6 x 35 mm</p>
<p>G x 55PCS(55 pièces)</p>  <p style="text-align: center;">Screws-M4 x 30 mm Vis-M4 x 30 mm</p>	<p>H x 2PCS(2 pièces)</p>  <p style="text-align: center;">Stop Drawers Tiroirs d'arrêt</p>	<p>K x 2PCS(2 pièces)</p>  <p style="text-align: center;">Stop Drawers Tiroirs d'arrêt</p>
<p>L x 4PCS(4 pièces)</p>  <p style="text-align: center;">Ø6x 70 mm</p>	<p>M x 2PCS(2 pièces)</p>  <p style="text-align: center;">Screws Ø6x90 mm Vis Ø6x90 mm</p>	<p>N x 2PCS(2 pièces)</p>  <p style="text-align: center;">Ø1/4" x 25 mm</p>
<p>S x 1PC(1 pièce)</p>  <p style="text-align: center;">Allen Key Clé Allen</p>	<p>Q x 8PCS(8 pièces)</p>  <p style="text-align: center;">Wheels-(H=28mm) Roues-(H=28mm)</p>	<p>R x 16PCS(16 pièces)</p>  <p style="text-align: center;">Screws M4 x15 mm Vis M4 x 15 mm</p>
<p>Y x 2PCS(2 pièces)</p>  <p style="text-align: center;">Slat catch size-(W=80mm) Taille du loquet à lamelles (W = 80 mm)</p>	<p>U x 2PCS(2 pièces)</p>  <p style="text-align: center;">Steel Bracket-2 pcs Support en acier - 2 pièces</p>	<p>Z x 4PCS(4 pièces)</p>  <p style="text-align: center;">Screws M3.5 x 12 mm Vis M3,5 x 12 mm</p>

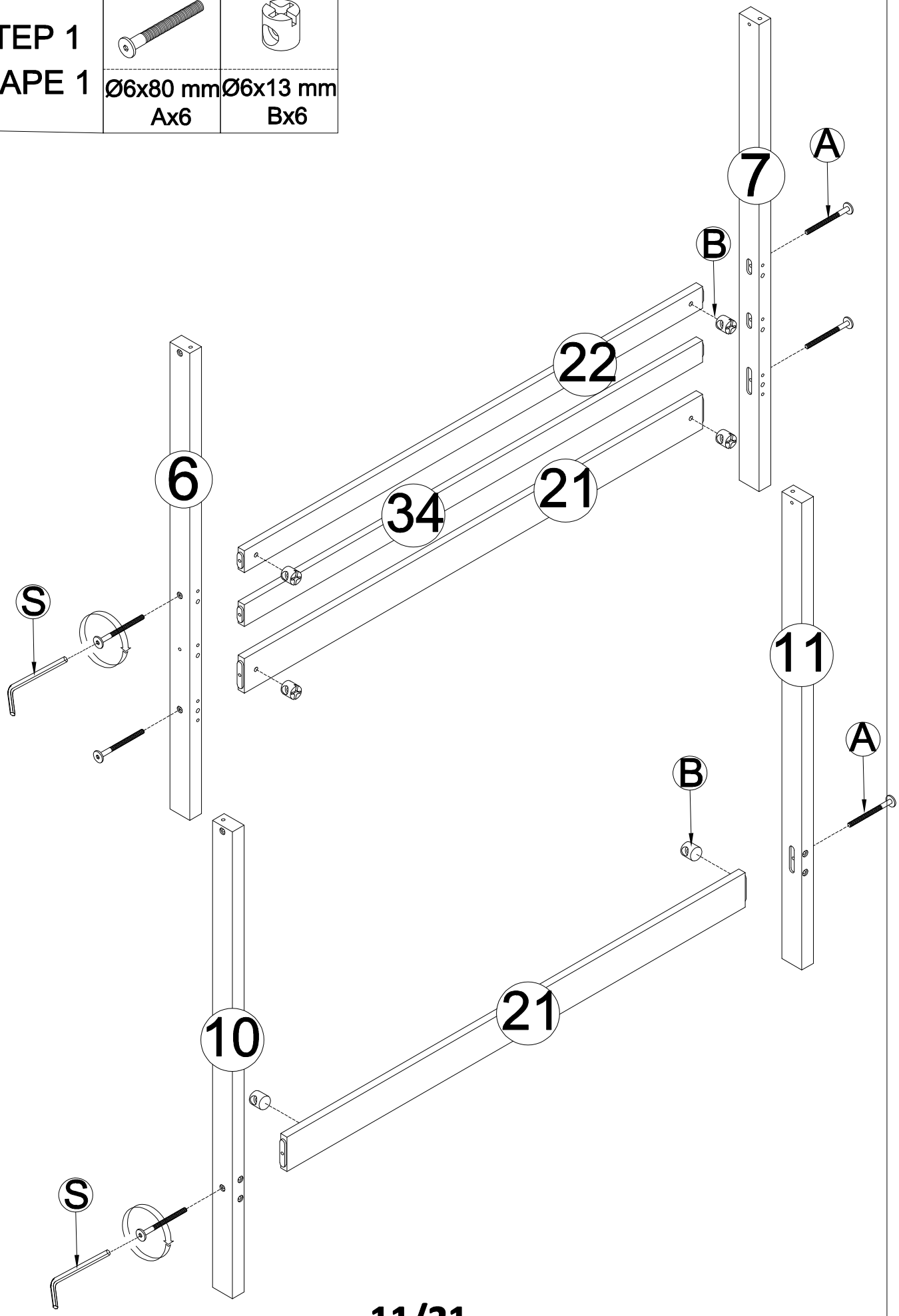

Assembly Tools Required (Not Included)
Outils d'assemblage requis (non inclus)

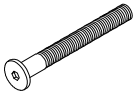
STEP 1 ÉTAPE 1		
	$\varnothing 6 \times 80 \text{ mm}$ Ax6	$\varnothing 6 \times 13 \text{ mm}$ Bx6

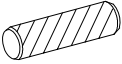
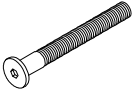

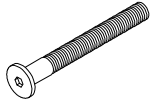
STEP 2-1 ÉTAPE 2-1						
	$\varnothing 6 \times 100 \text{ mm}$ Dx12	$\varnothing 6 \times 13 \text{ mm}$ Bx16	$\varnothing 10 \times 40 \text{ mm}$ Cx12	$\varnothing 6 \times 70 \text{ mm}$ Lx4	$\varnothing 6 \times 15 \text{ mm}$ Ex4	$\varnothing 6 \times 35 \text{ mm}$ Fx4

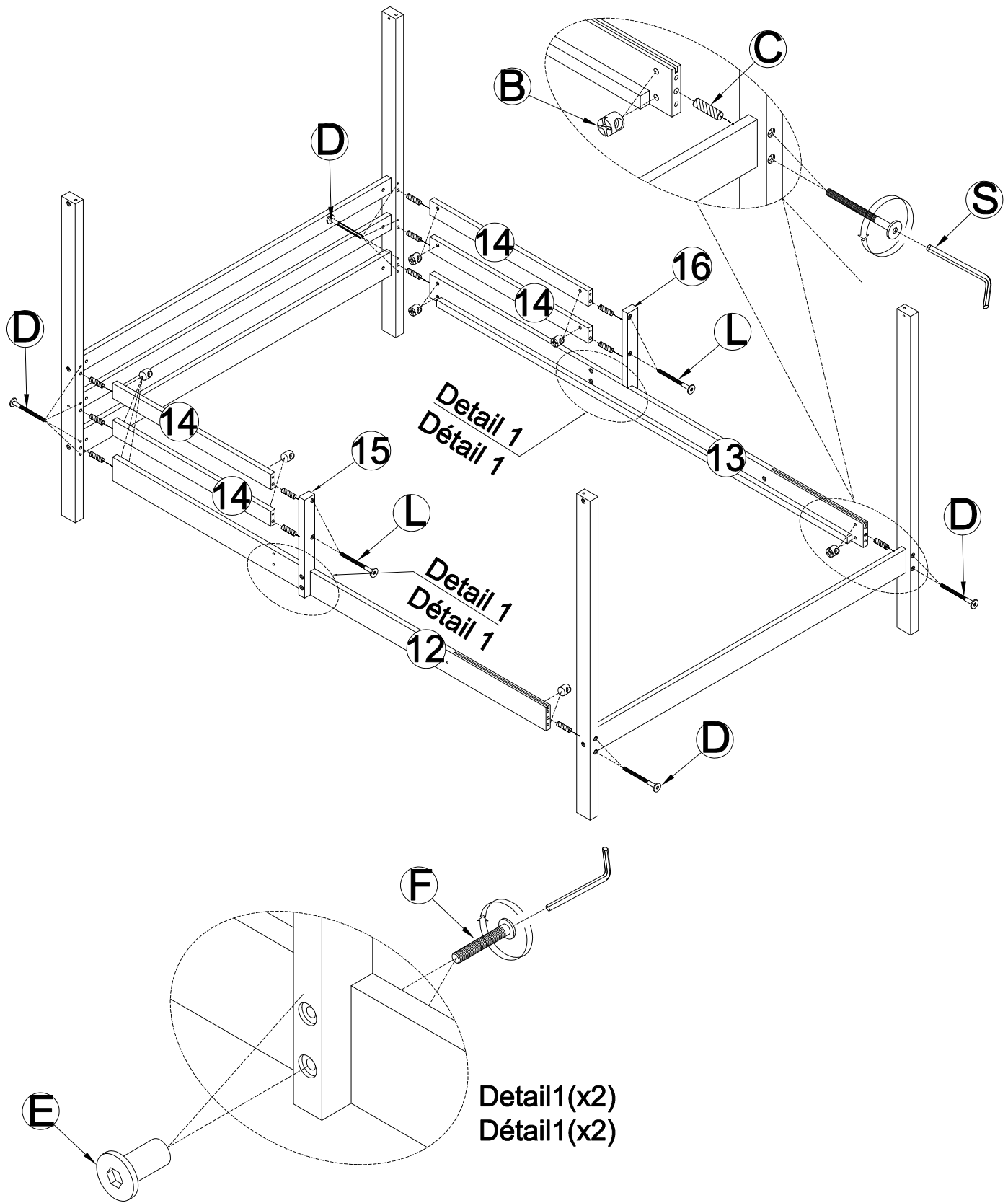

STEP 2-2
ÉTAPE 2-2

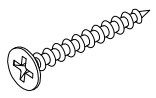

M4x30 mm
Gx8

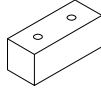

Hx2

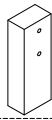

Kx2

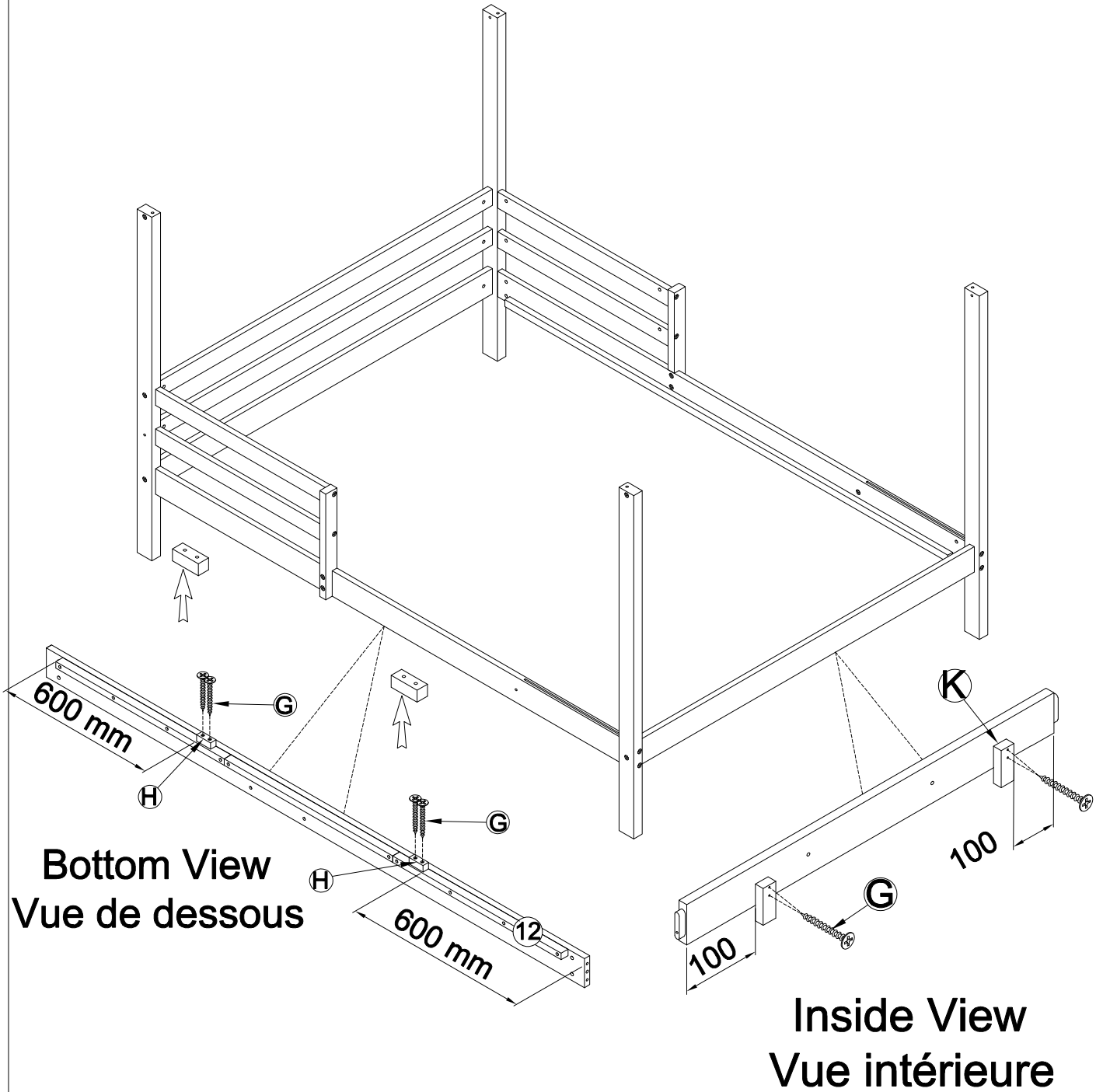

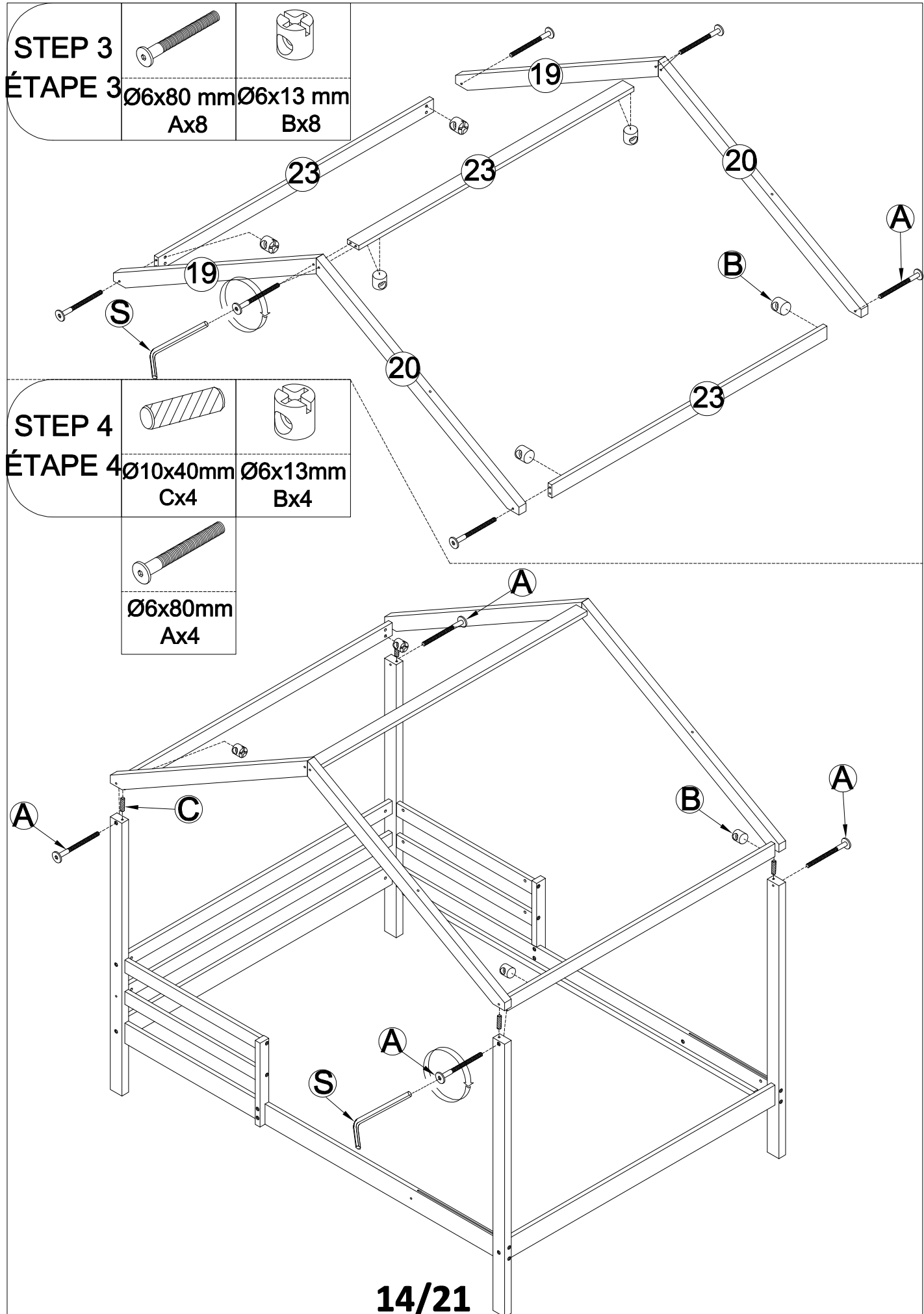

STEP 3

ÉTAPE 3

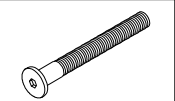

Ø6x80 mm
Ax8



Ø6x13 mm
Bx8

STEP 4

ÉTAPE 4

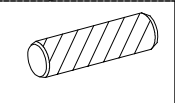

Ø10x40mm
Cx4



Ø6x13mm
Bx4

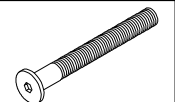

Ø6x80mm
Ax4

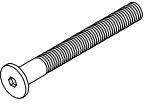
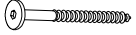
STEP 5 ÉTAPE 5			
	Ø6x15 mm Ex2	Ø6x25 mm Nx2	Ø6x90 mm Mx2

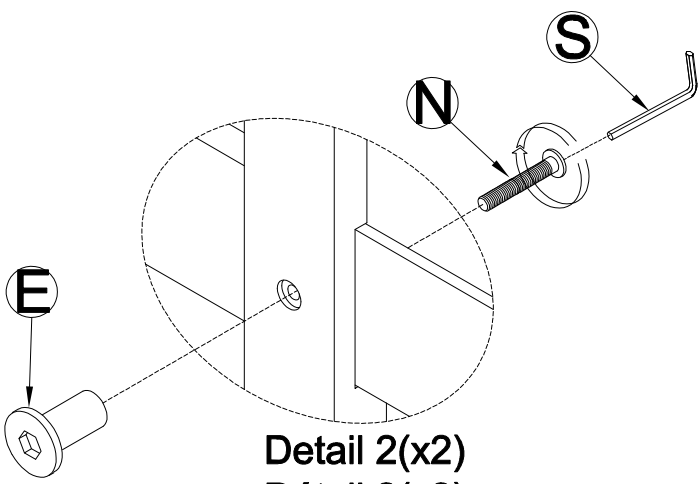
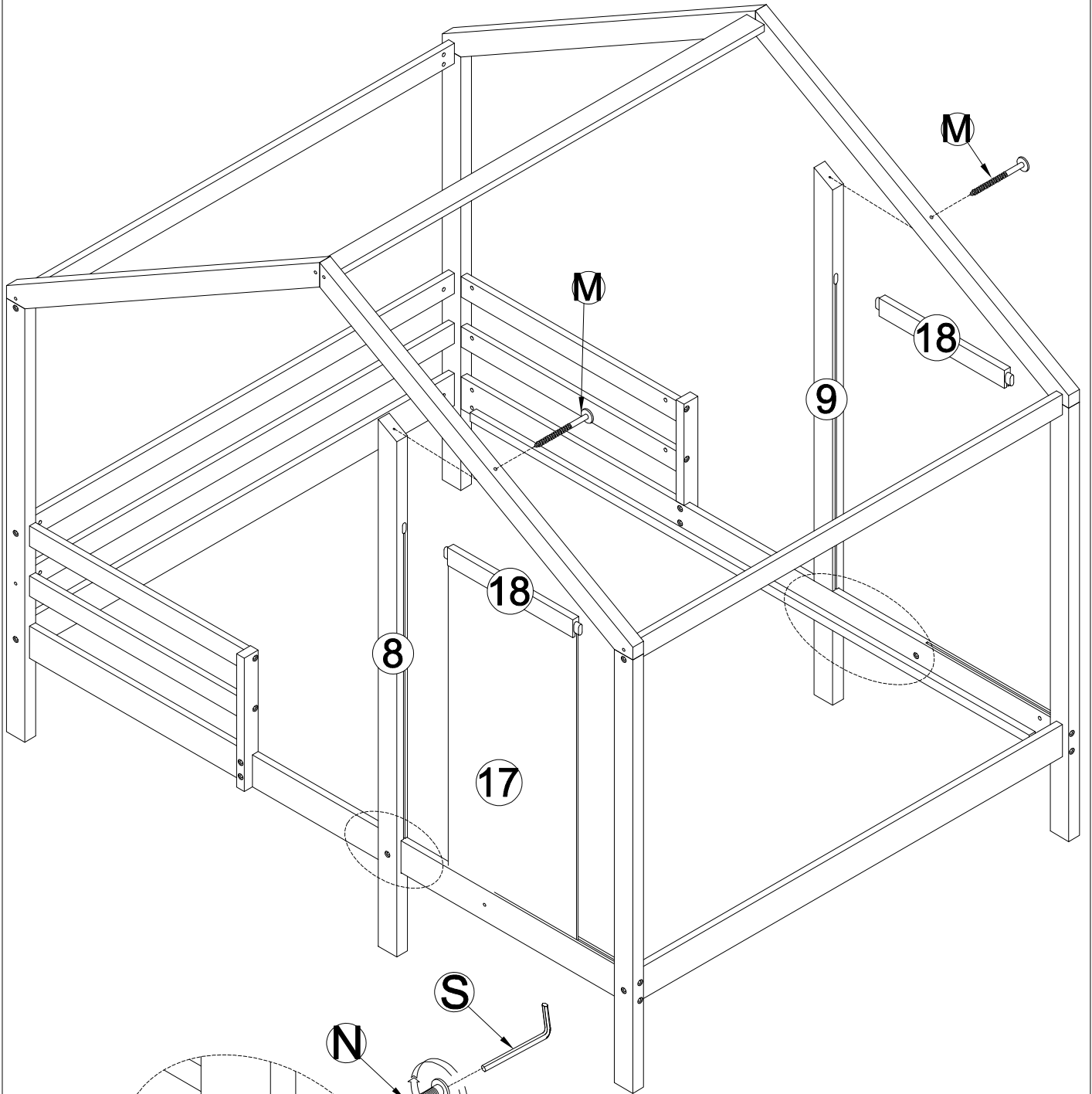

Detail 2(x2)
 Détail 2(x2)

STEP 6
ÉTAPE 6

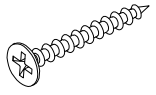

M4x30 mm
Gx28

Use this to align and
assemble the slats
Utilisez-le pour aligner et
assembler les lattes

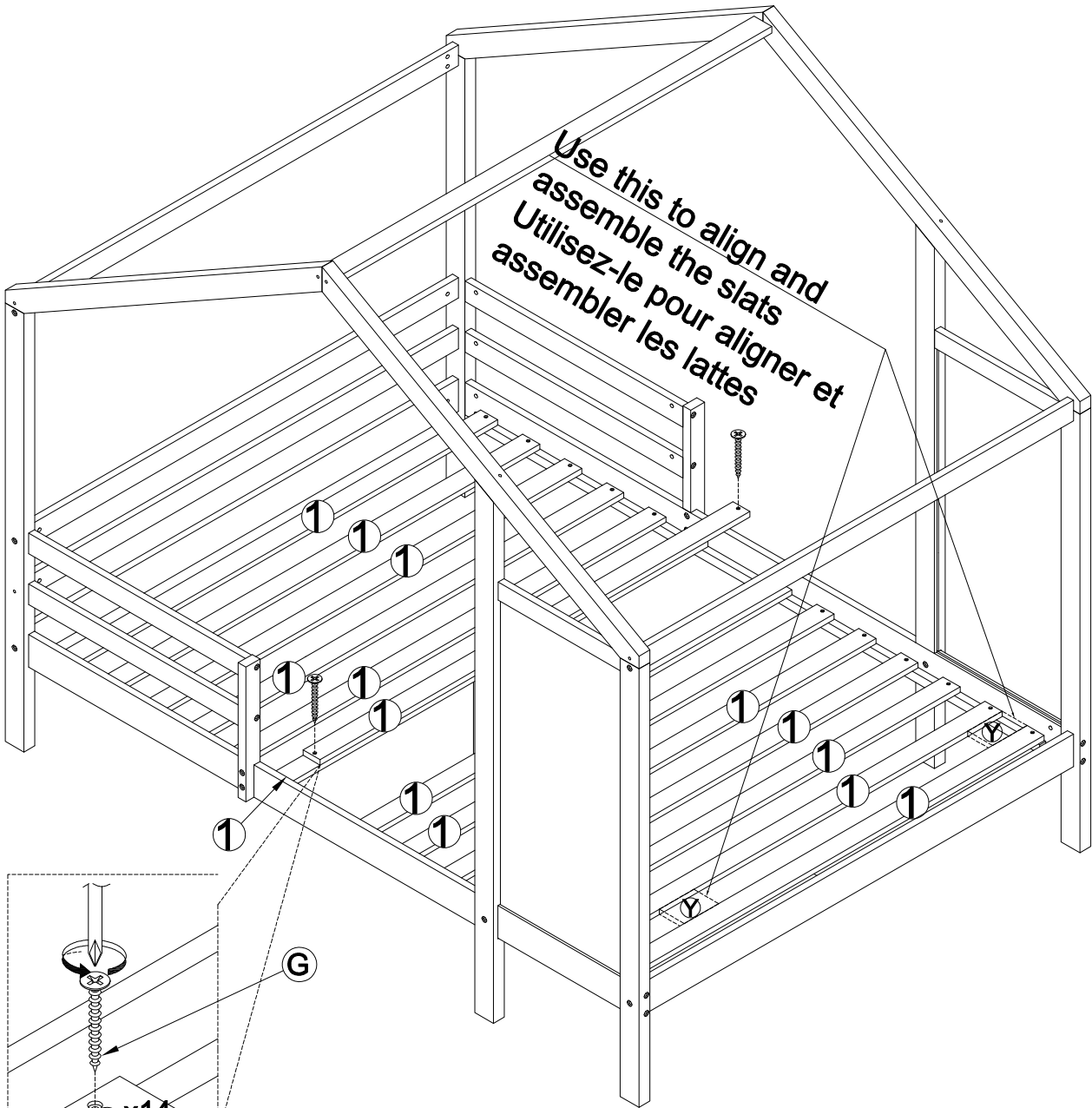

STEP 7-1
ÉTAPE 7-1

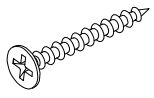

M4x30 mm
Gx4

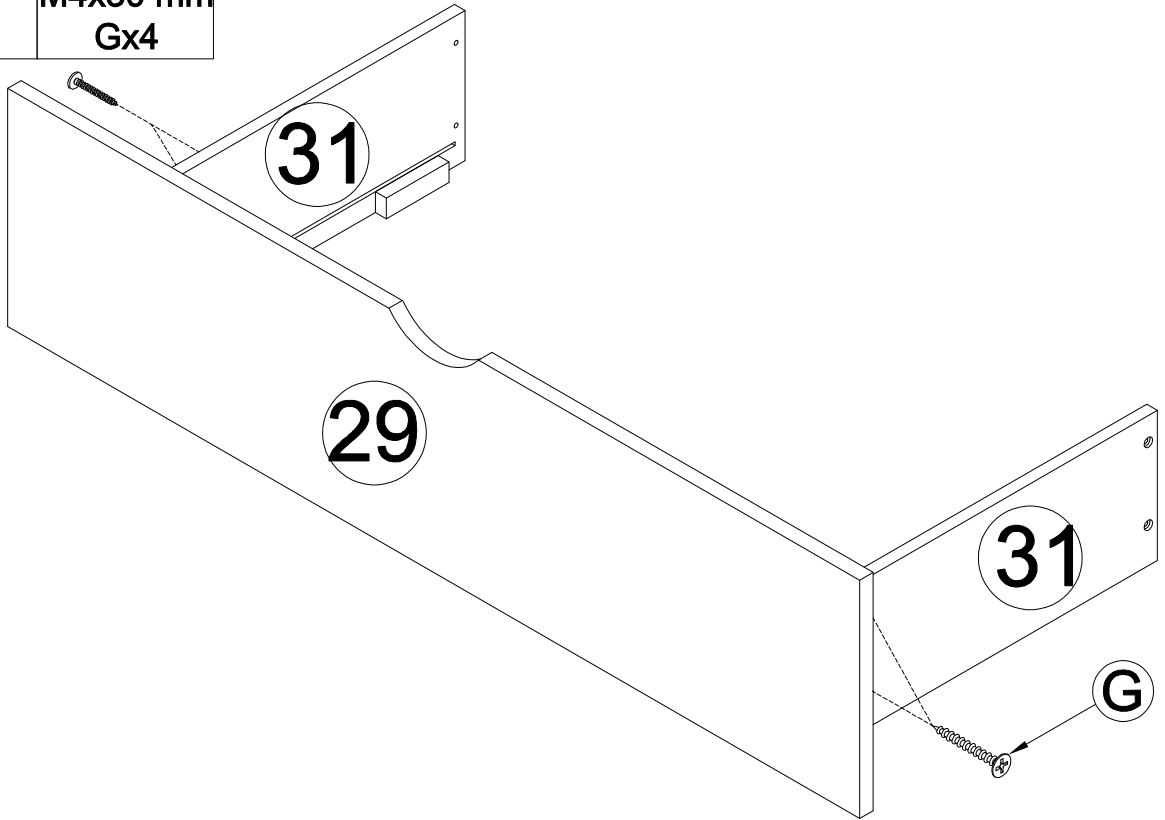

STEP 7-2
ÉTAPE 7-2

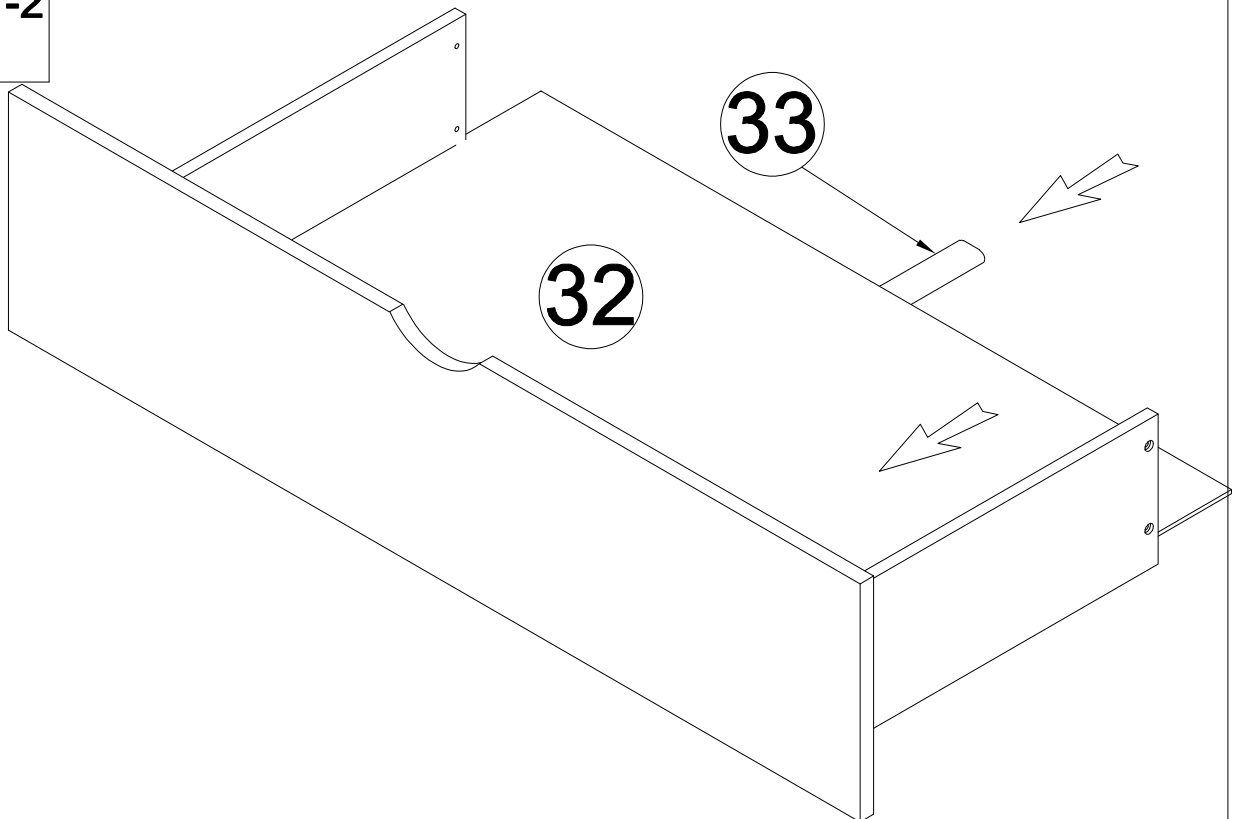

STEP 7-3

ÉTAPE 7-3

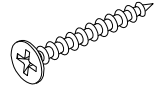

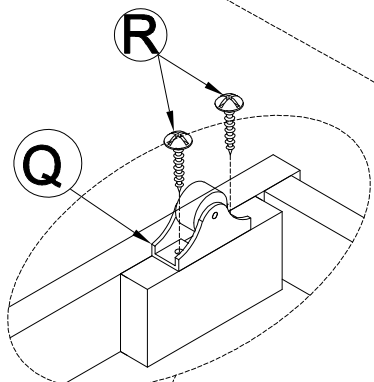
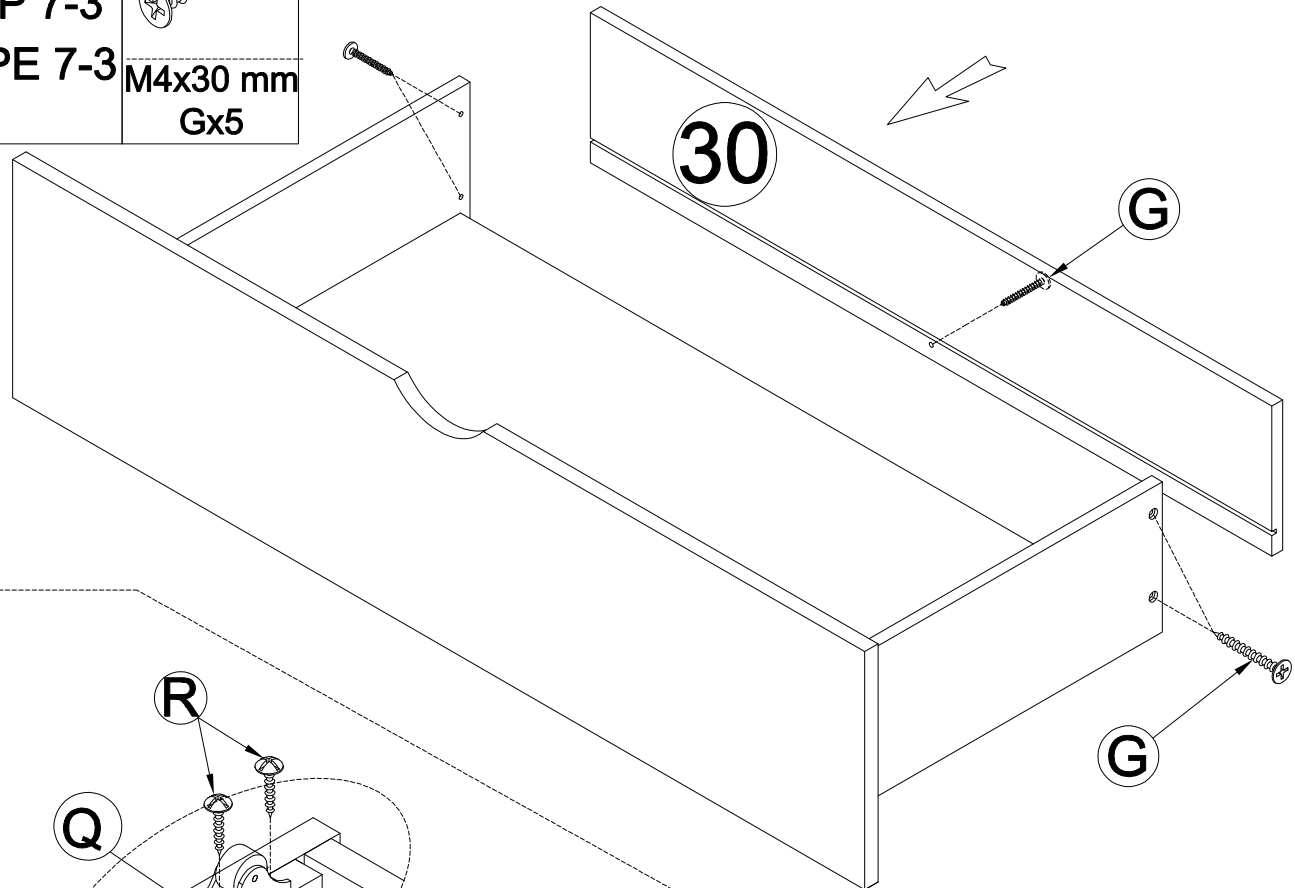
M4x30 mm
Gx5

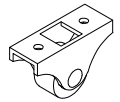

STEP 7-4

ÉTAPE 7-4

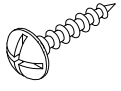
H=28mm
Qx4

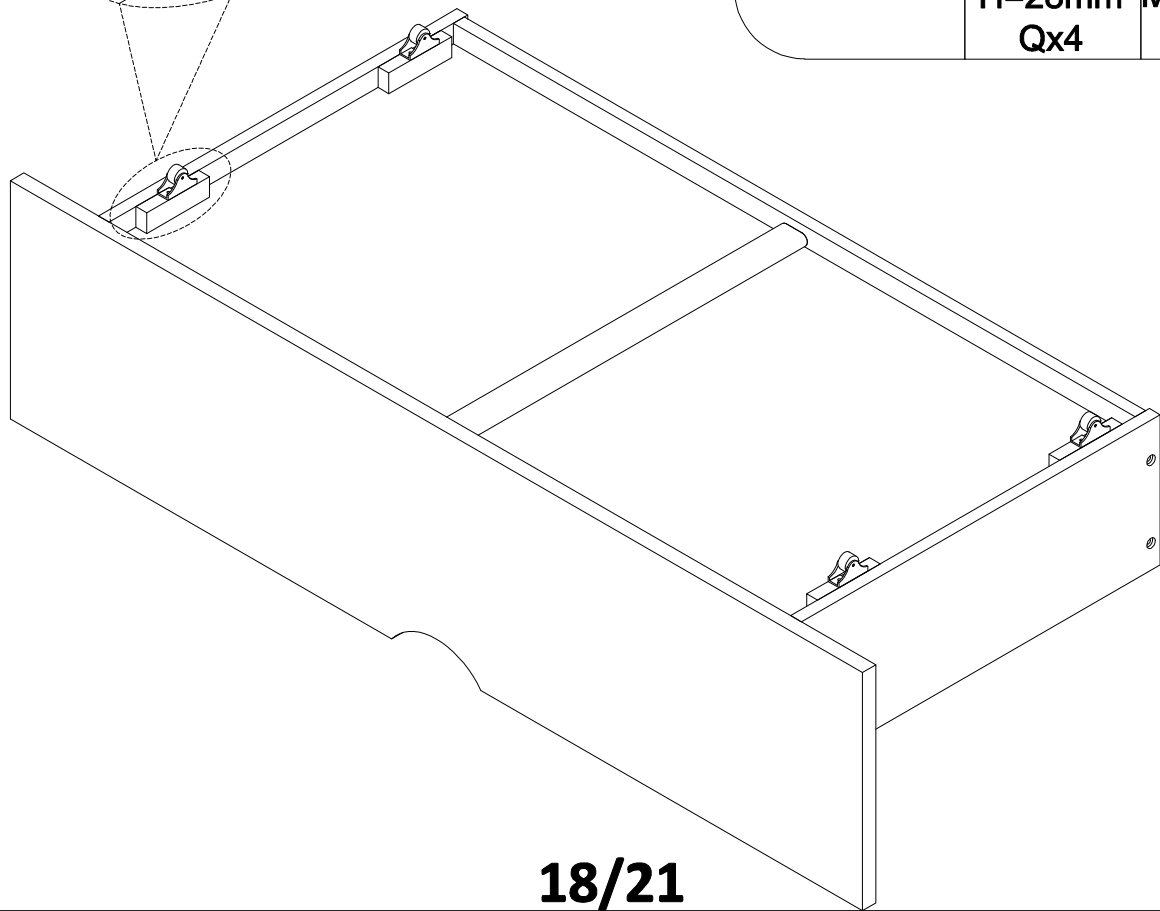

M4x15 mm
Rx8

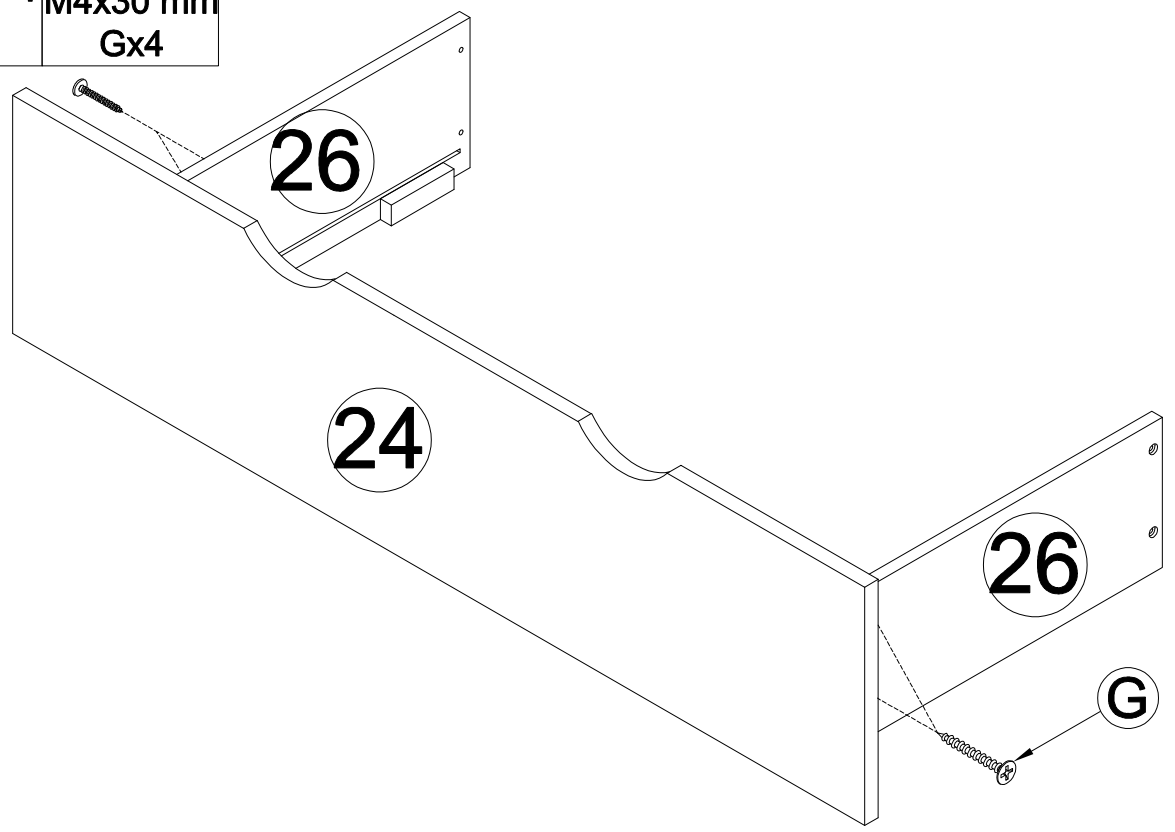
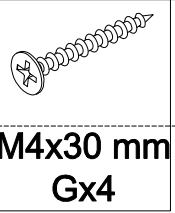

STEP 8-1
ÉTAPE 8-1

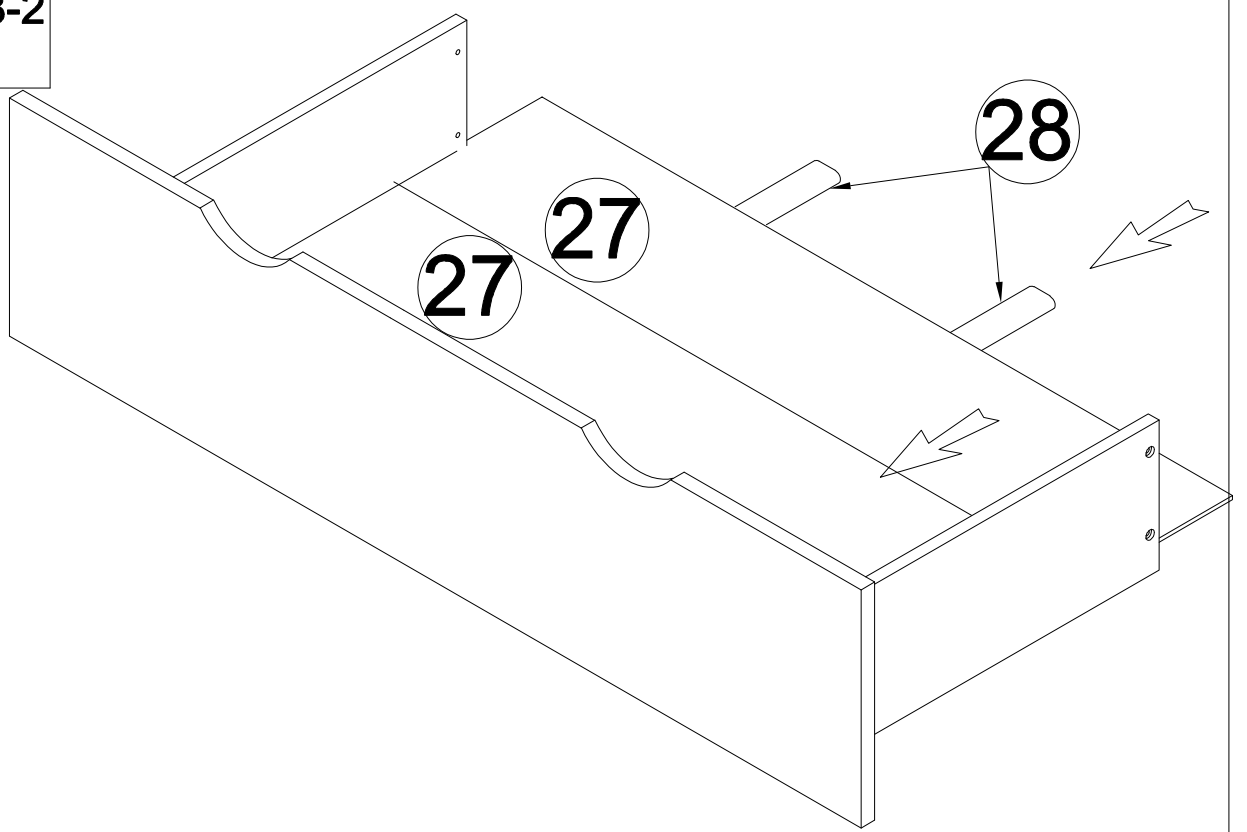

STEP 8-2
ÉTAPE 8-2



STEP 8-3

ÉTAPE 8-3

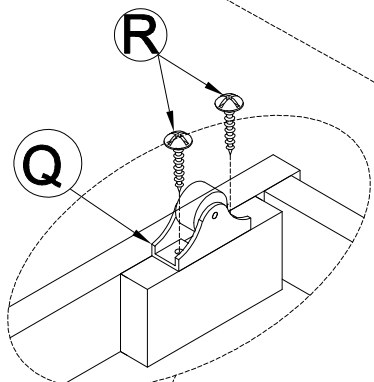
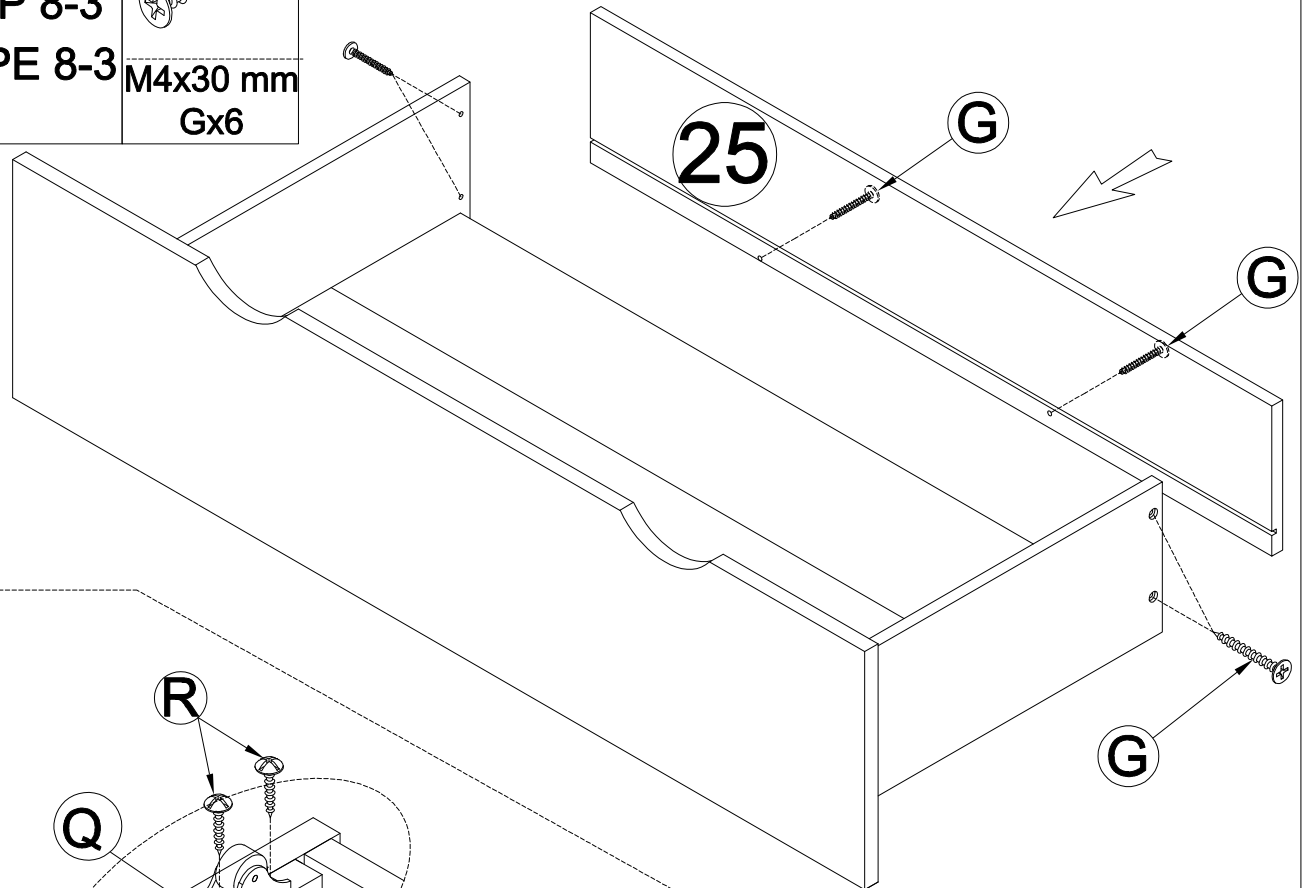
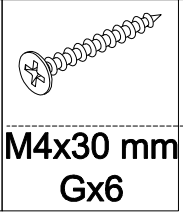

STEP 8-4

ÉTAPE 8-4

H=28mm Qx4	M4x15 mm Rx8
M3.5x12mm Zx4	Ux2

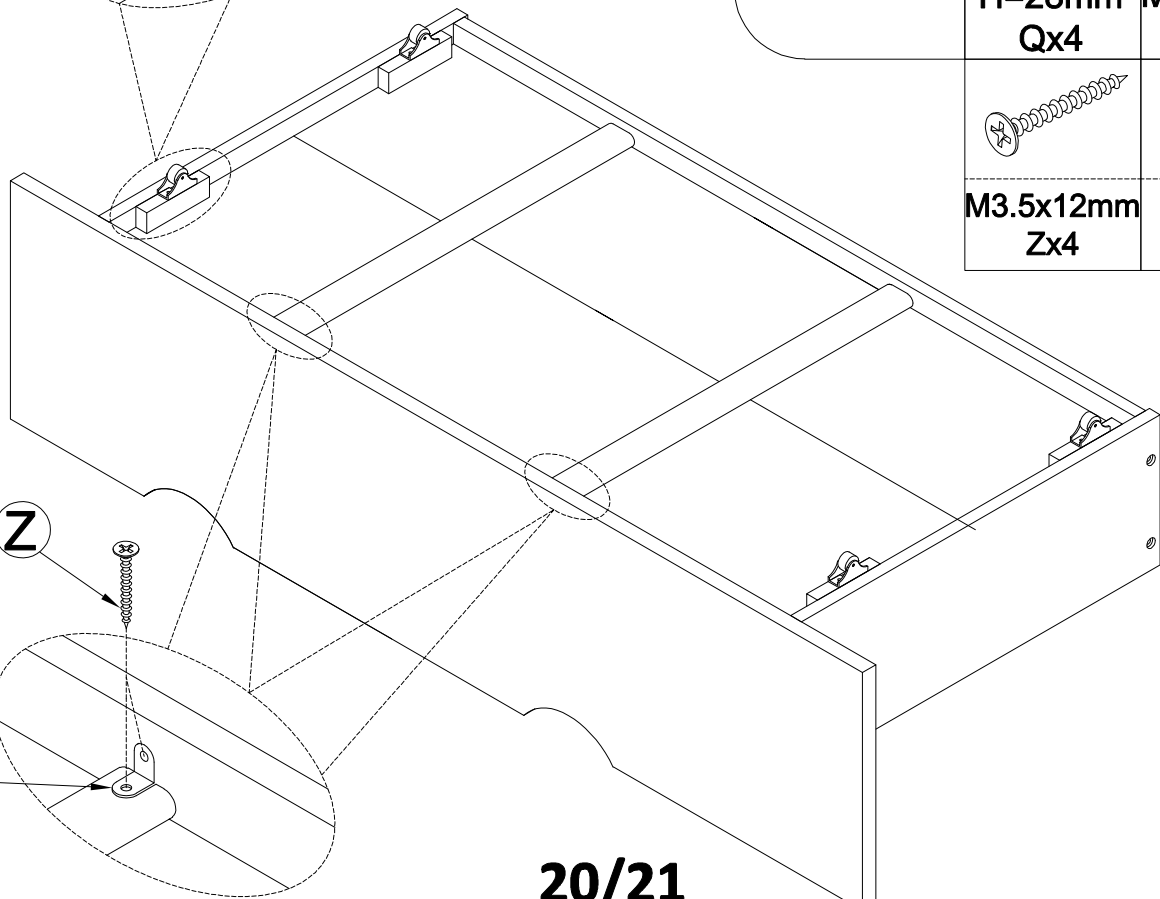

CONGRATULATION. YOU HAVE COMPLETED THE BED
Push 2 Drawer into position
FELICITATIONS. VOUS AVEZ TERMINÉ LE LIT
Poussez les 2 tiroirs en position

