

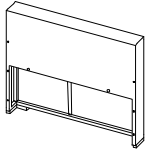

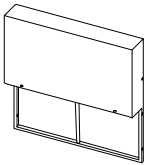

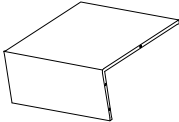

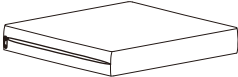

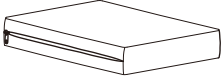

PART LIST

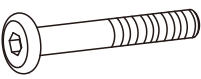
A 	B 	C 	D 	E 
Arm Panel 2 PCS	Back Panel 1 PC	Seat Panel 1 PC	Cover of Seat Cushion * 1 PC	Core of Seat Cushion 1 PC
F 	G 	*Please note cushion covers will ship separately.		
Cover of Back Cushion * 1 PC	Core of Back Cushion 1 PC			

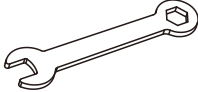
HARDWARE LIST

#1 	#2 	#3 	#4 	#5 
M6*50mm Bolt 16PCS	M6mm Nut 16 PCS	D18mm Washer 32 PCS	M6mm Wrench 1 PC	M6mm Allen Key 1 PC

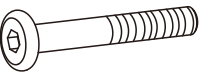
EXTRA HARDWARE LIST

#1 	#2 	#3 
M6*50mm Bolt 1 PC	M6mm Nut 1 PC	D18mm Washer 1 PC

Step 1. Lay back panel (part B) down on a soft flat surface, such as carpet, as shown below. Attach arm panel (part A) to back panel (part B) using bolts (part #1), washers (part #3), nuts (part #2), wrench (part #4) and allen key (part #5).

NOTE: Please do not fully tighten bolts until unit is fully assembled.

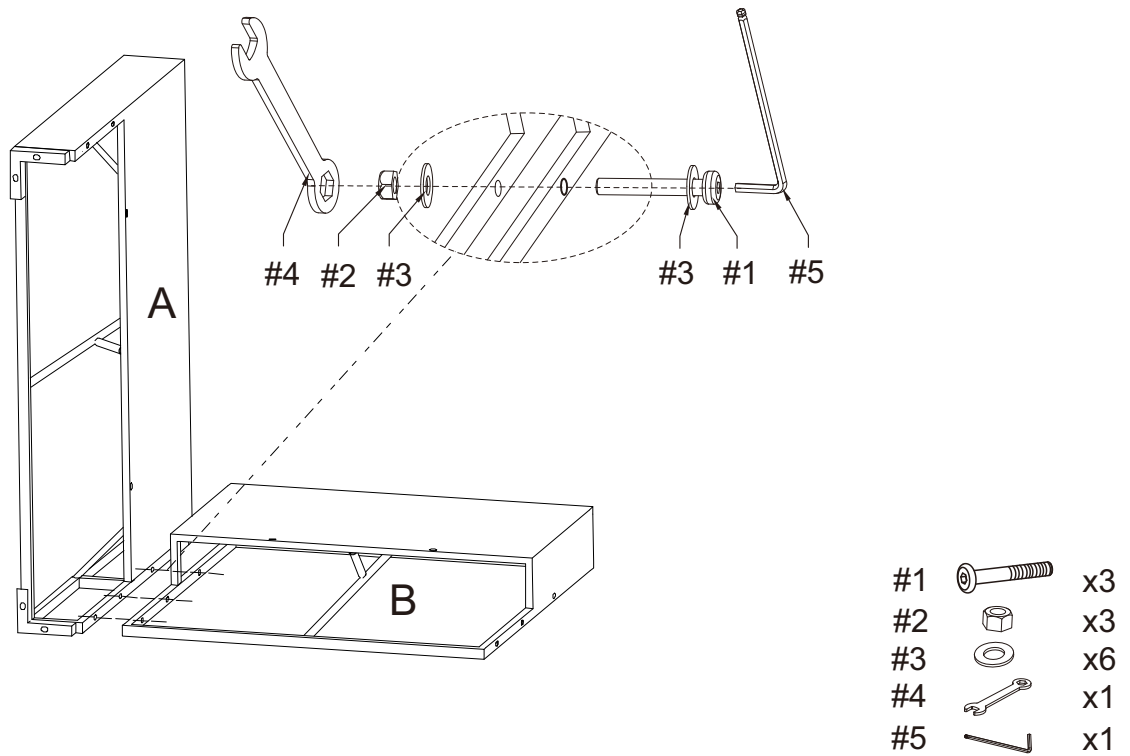

Step 2. Attach seat panel (part C) to assembled unit (parts A&B) using bolts (part #1), washers (part #3), nuts (part #2), wrench (part #4) and allen key (part #5).



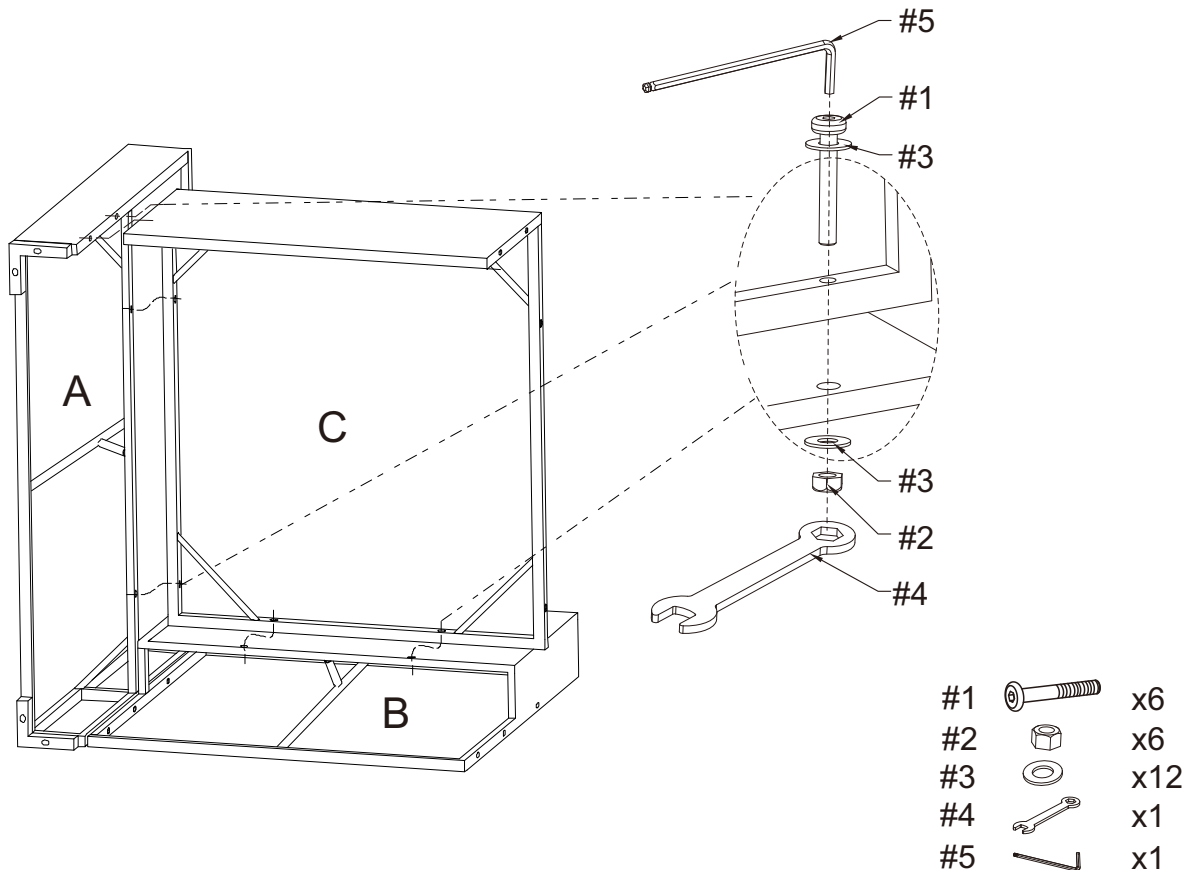

NOTE: Please do not fully tighten bolts until unit is fully assembled.

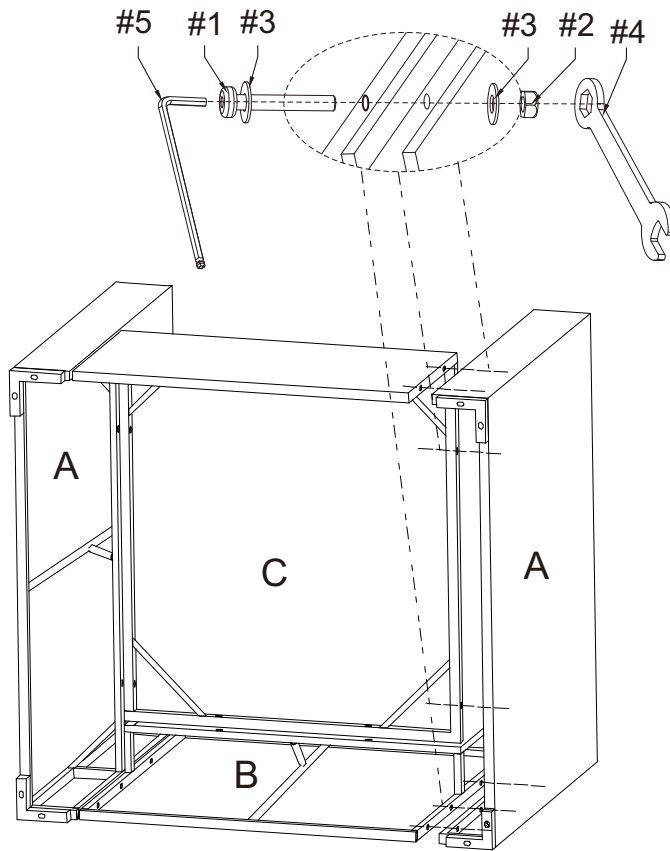

Step 3. Attach arm panel (part A) to assembled unit (parts C&B) using bolts (part #1), washers (part #3), nuts (part #2), wrench (part #4) and allen key (part #5).

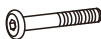
NOTE: Please fully tighten all bolts at this time.



- | | | |
|----|---|-----|
| #1 |  | x7 |
| #2 |  | x7 |
| #3 |  | x14 |
| #4 |  | x1 |
| #5 |  | x1 |

Step 4. Insert core of seat cushion (part E) into cover of seat cushion (part D).
Insert core of back cushion (part G) into cover of back cushion (part F).

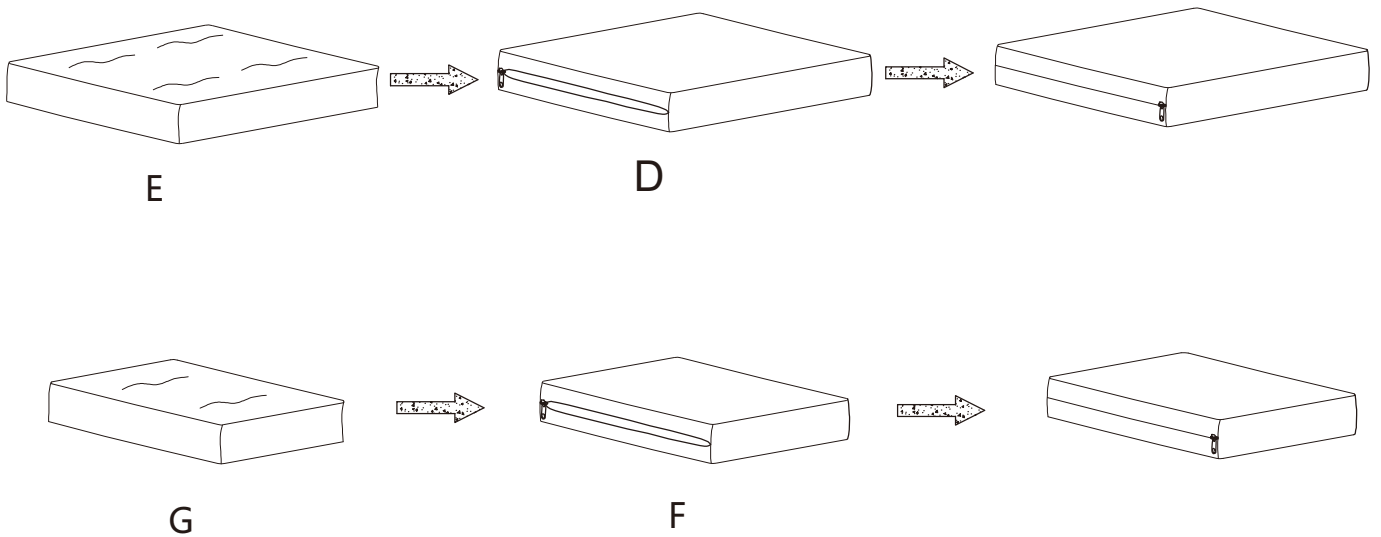

Step 6. Carefully turn the assembled chair upright and add cushions as shown below.

