

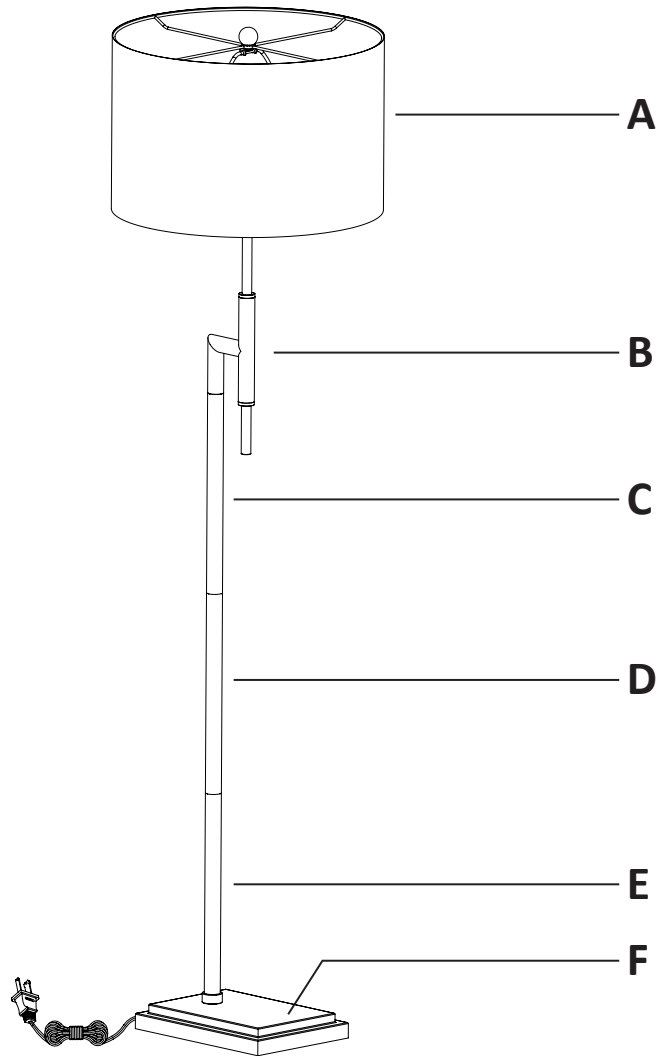



USE AND CARE MANUAL

FLOOR LAMP

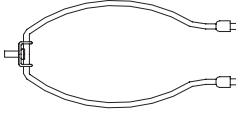
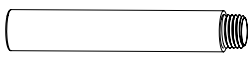

Hardware (Parts are not to scale)

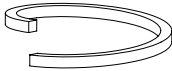
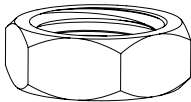
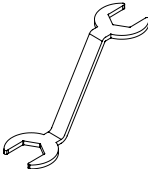
<p>H1 Finial (Pre-assembled to harp (H2)) 1 pc</p> 	<p>H2 Harp 1 pc</p> 	<p>H3 Decoration tube 1 pc</p> 	<p>H4 Flat washer 1 pc</p> 
<p>H5 Spring washer 1 pc</p> 	<p>H6 Hex nut 1 pc</p> 	<p>H7 Wrench 1 pc</p> 	

THIS MANUAL CONTAINS IMPORTANT SAFETY INFORMATION. PLEASE READ AND KEEP FOR FUTURE REFERENCE.

IMPORTANT SAFETY INFORMATION

- This lamp is for indoor use only. The lamp should not be used near water. Never immerse the lamp in water or other liquids.
 - Never cover the lamp with any object including cloth or paper as this is a fire hazard.
 - Do not handle the bulb immediately after the light is turned off as it will be hot.
 - This portable lamp has a polarized plug (one blade is wider than the other) as a safety feature to reduce the risk of electric shock. This plug will fit into a polarized outlet only one way. If the plug does not fit fully into the outlet, reverse the plug. If it still does not fit, contact a qualified electrician. Never use with an extension cord unless plug can be fully inserted. Do not alter the plug.
-

PREPARATION

- Before beginning assembly, installation or operation of product, make sure all parts are present. Compare parts with package contents list and diagram on previous page. If any part is missing or damaged, do not attempt to assemble, install or operate the product. Contact customer service for replacement parts.
-

ASSEMBLY

1 Assembling the tubes

- Pull the excess power cord through the tube (E).
- Tighten the tube (C) onto the socket assembly (B).
- Tighten the tube (D) onto the tube (C).
- Tighten the tube (E) onto the tube (D).

NOTE: Do not twist the power cord.

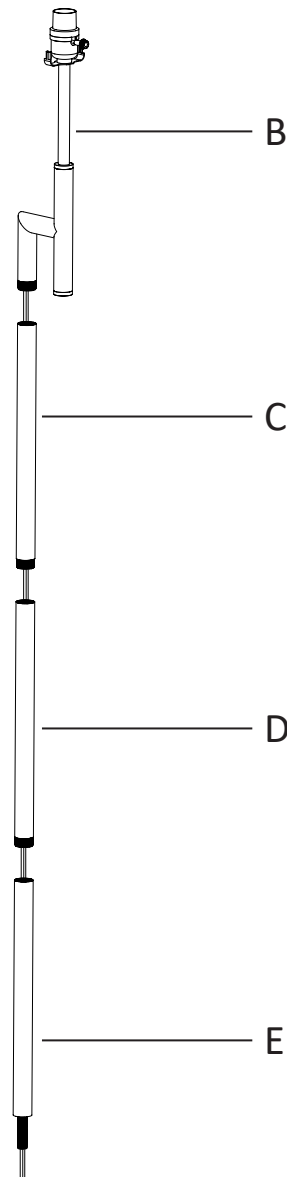

ASSEMBLY (continued)

2 Assembling the tube assembly onto the base

- Pull the excess power cord through the base (F).
- Handle the tube assembly in vertical position and then slide the threaded tube at the bottom of the tube (E) through the hole on the base (F) as shown. Adjust the socket assembly (B) is facing the front of the lamp, then secure the tube assembly with the flat washer (H4), the spring washer (H5) and the hex nut (H6) by the wrench (H7).

NOTE: Do not twist the power cord.

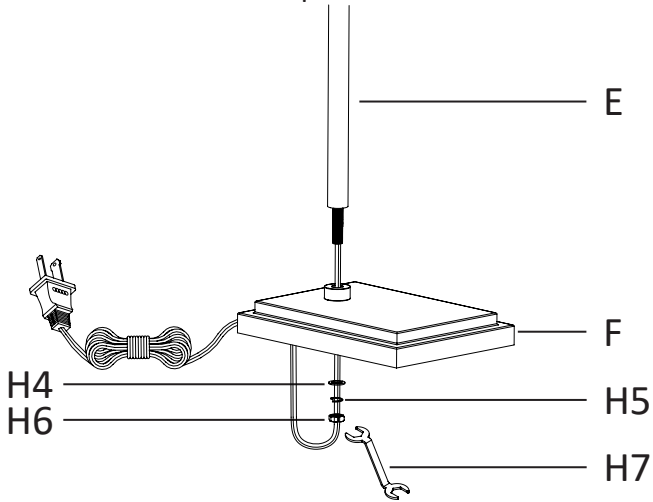

3 Assembling the harp

- Insert the harp (H2) prongs into the saddle of the socket assembly (A) and slide the retaining covers over joints to secure the harp.
- Screw the decoration tube (H3) into the bottom of the socket assembly (B).

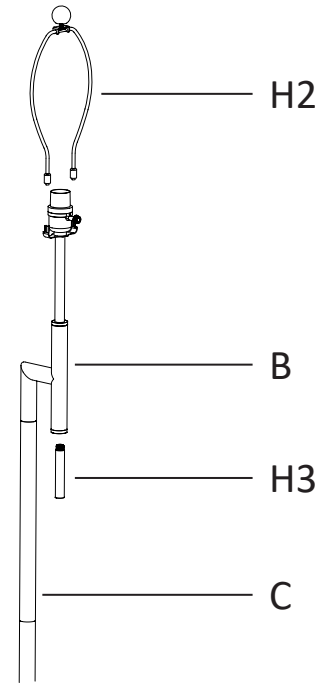

4 Assembling the shade

- Unscrew the finial (H1) from the harp (H2).
- Place the shade (A) onto the harp (H2) and secure with the finial (H1).

NOTE: Grasp the finial (H1) to adjust the shade (A) to level if shade is skewed. Remove the plastic cover from the shade before using.

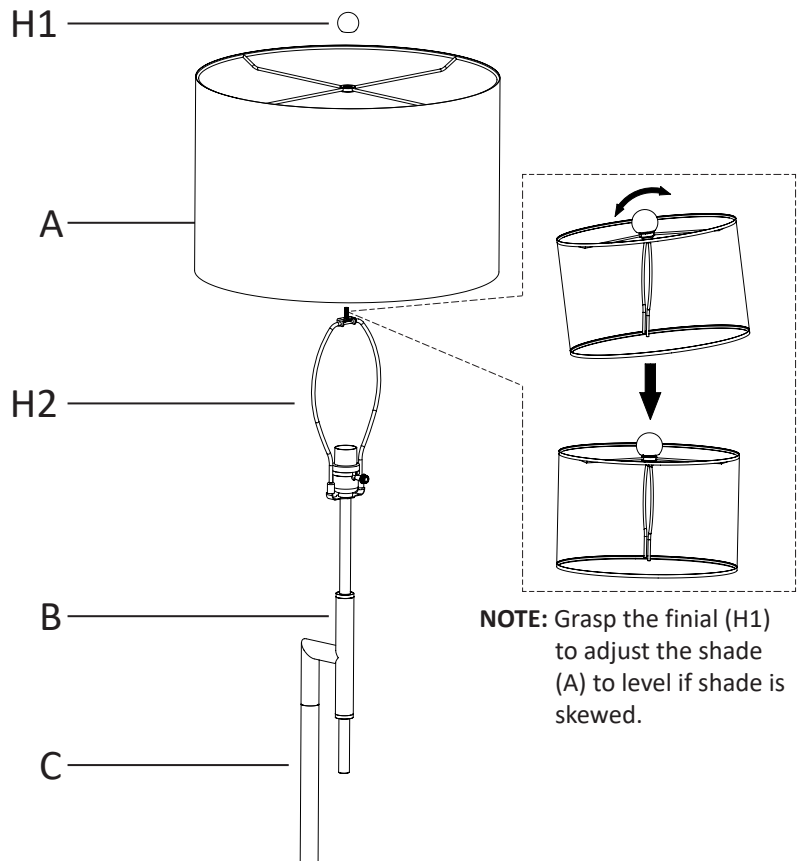

ASSEMBLY (continued)

5 Installing the light bulb

- Install the light bulb (not provide) into the socket. Use one **MAX 150W medium base (E26) type "A"** bulb (recommended).
- Plug into the wall outlet, turn the switch clockwise and enjoy.

NOTE: You can also use one **MAX 16W medium base (E26) self-ballasted LED** bulb. Do not exceed the recommended wattage.

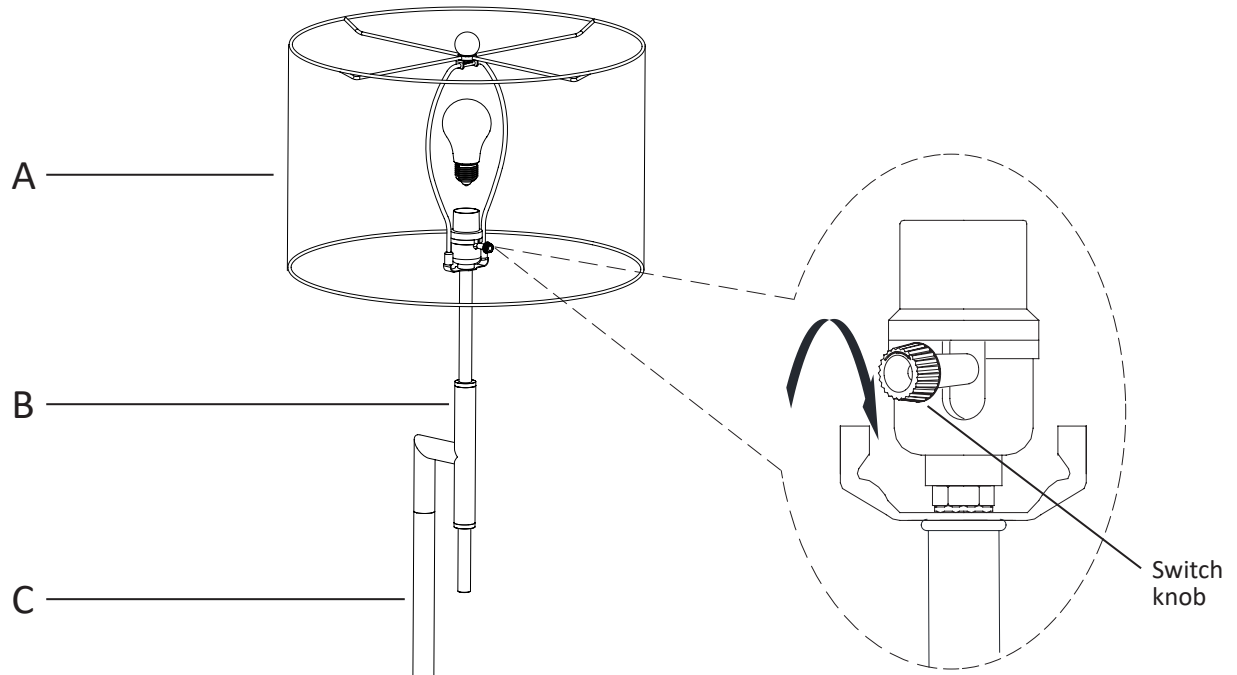

CLEANING

- Do not use any cleaners with chemicals, solvents, or harsh abrasives. Use only a dry, soft cloth to dust or wipe carefully.
- To clean the fixture, pull the plug from the wall outlet. Use a dry or slightly dampened, clean cloth to wipe the exterior surface of the fixture.

TROUBLESHOOTING

- The light does not come on at all:
 - a) Ensure whether the bulb is burned out.
 - b) Ensure the power supply is turned on.
 - c) Ensure the cord is plugged into an outlet.
 - d) Ensure the circuit breaker is set in the "ON" position.
- Fuse blows or circuit trips when light is turned on.
 - a) Check for crossed wires, ensure wiring is correct.

