

# Assembly Instructions

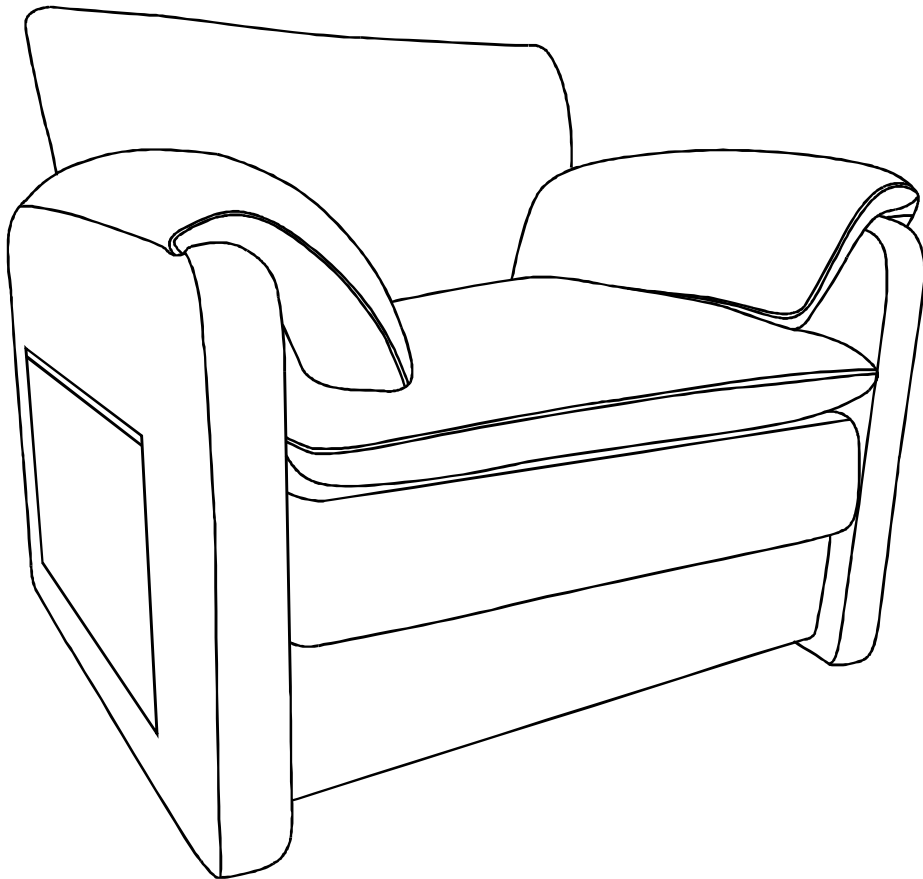

TIME



2 OF PEOPLE



DIFFICULTY

## NOTICE

### Instruction Booklet - Important Safety Information

Thank you for choosing our product. Please review this booklet carefully for essential safety information and keep it for future reference.

- Upon receiving the product, ***ensure all parts are present and intact*** before proceeding with installation. Follow the entire installation instructions provided.
- During installation, be careful not to tighten the screws immediately. Secure all screws to 80% before final tightening.
- Note: Cushions are ***compressed*** and cannot be recompressed once opened. Returns are accepted only for items in their ***original, unopened condition***.

For assistance, contact our support team if you encounter the following issues:







- A. The outer box is damaged.
- B. The product is damaged/bent/cracked while you open the box.
- C. The parts/accessories/assembly tools are missing.
- D. The instructions are not clear and cannot be referred to.
- E. The product has functional problems.
- F. Other aspects that you are not satisfied with.

Your satisfaction is our priority, and we're here to assist you every step.

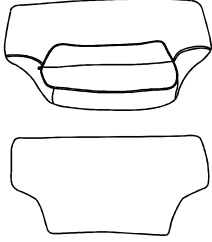
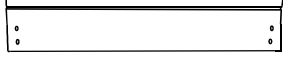
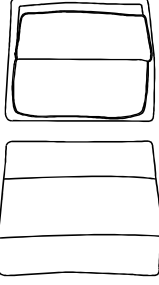

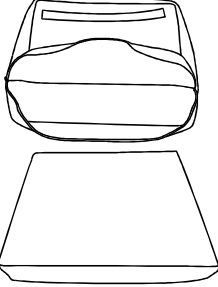
**Before installation, please check that the parts are all included !**

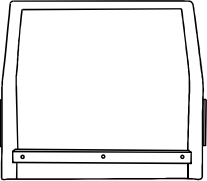
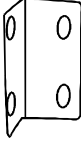
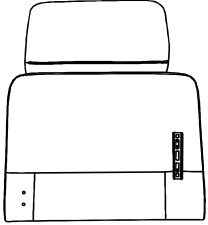
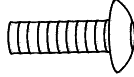
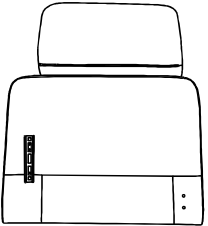
# PART LISTS

Part NO.	Part Image	QTY	Part NO.	Part Image	QTY
A		1	G		1
B		1	H		1
C		1	I		2
D		1	J		2
E		1	K	 M6x18mm	8
F		1	L		1

## Installation Steps

### STEP 1

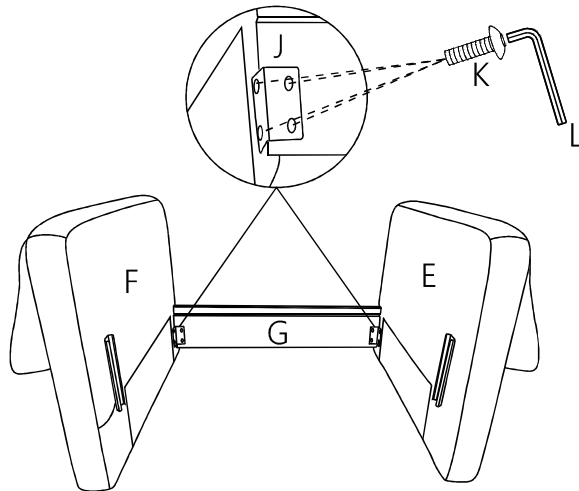

Connect the front board part G with the armrest parts E and F

### STEP 2

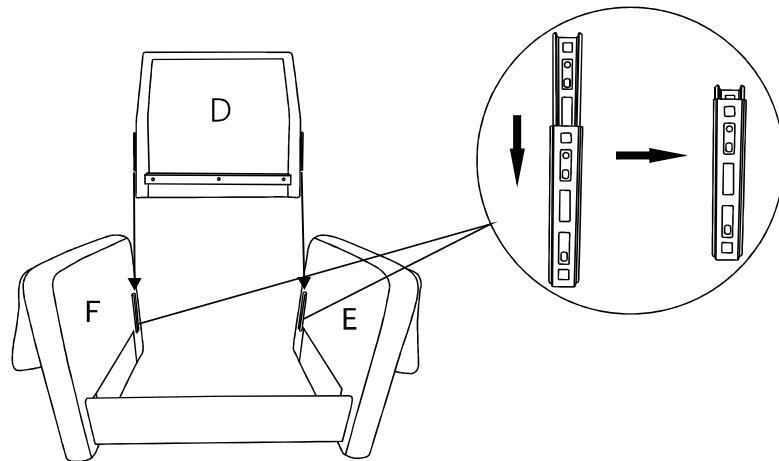

Insert the backrest D into the armrest parts E and F

### STEP 3

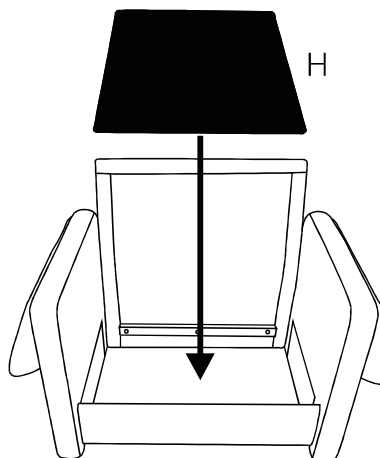

Place the seat support part H in the middle of the chair

## Installation Steps

### STEP 4

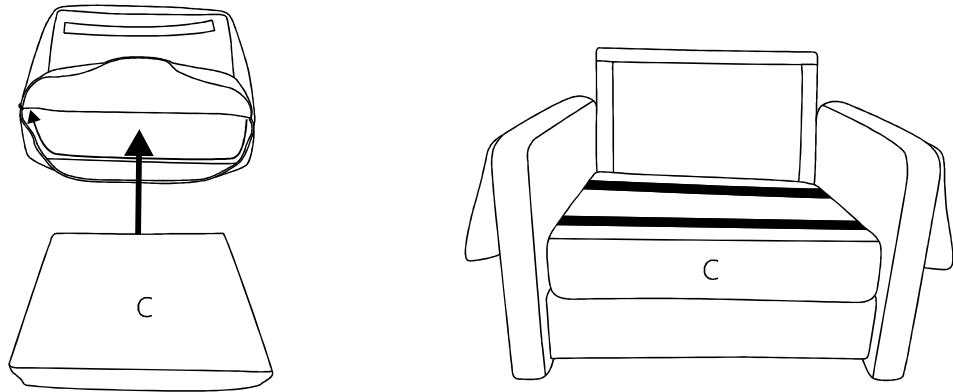

Place cushion parts C on part H  
(Note: After unpacking the compress cushions, gently tap them and allow 48 hours for them to return to it's original state.)

### STEP 5

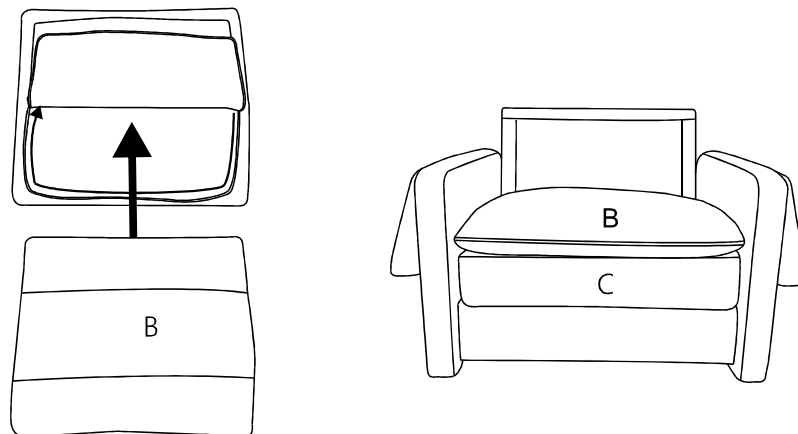

Place cushion parts B on part C  
(Note: After unpacking the compress cushions, gently tap them and allow 48 hours for them to return to it's original state.)

### STEP 6

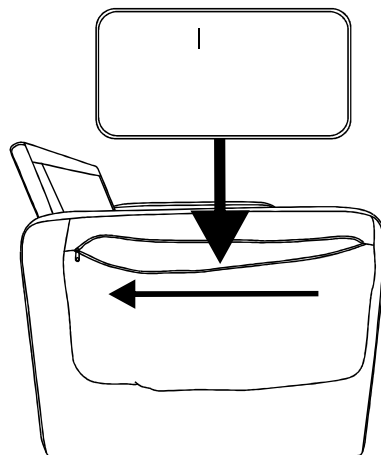

Insert the armrest inner bag part I into the armrest cover  
(Note: After unpacking the compress cushions, gently tap them and allow 48 hours for them to return to it's original state.)

## Installation Steps

### STEP 7

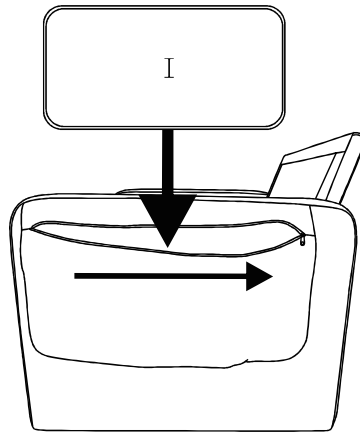

Insert the armrest inner bag part I into the armrest cover  
(Note: After unpacking the compress cushions, gently tap them and allow 48 hours for them to return to it's original state.)

### STEP 8

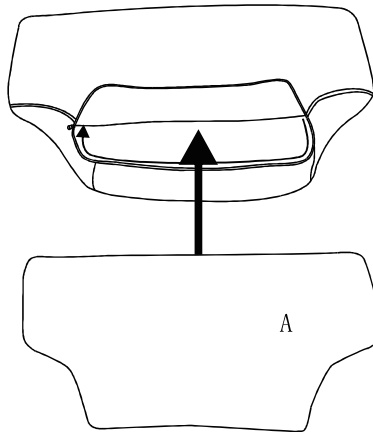

Insert the backrest inner bag part A into the armrest cover  
(Note: After unpacking the compress cushions, gently tap them and allow 48 hours for them to return to it's original state.)

### STEP 9

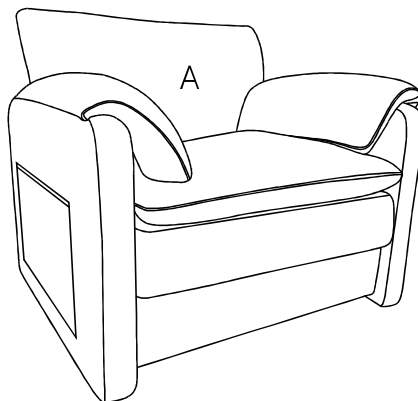

Place the backrest part A on the chair.  
(Note: After unpacking the compress cushions, gently tap them and allow 48 hours for them to return to it's original state.)

# Care

## Instructions

Your furniture, when treated with care and affection, will endure for years to come. Each piece demands gentle upkeep to enhance daily comfort and extend its lifespan. Just like any cherished possession, when treated kindly, it reciprocates that kindness. Your furniture is crafted to support you and bring joy into your life, enriching your home and your experiences.

**1. Place the sofa away from direct sunlight, or utilize curtains or blinds to minimize exposure.**

**2. Regularly clean the sofa with a dry, soft cloth or a vacuum equipped with a gentle attachment.**

**3. Address stubborn stains promptly by blotting the affected area with a soft cloth soaked in warm water and mild soap. Follow up by drying with a clean cloth.**

**4. Avoid excessive rubbing during cleaning, as it may damage the weave and cause discoloration.**

**5. We recommend affixing felt pads underneath the sofa to prevent floor scratches. Additionally, laying a rug beneath can provide both protection and aesthetic appeal to your living space.**

**6. Ensure even weight distribution on the cushions regularly for optimal care.**

By adhering to these care instructions, your furniture will continue to serve you well in return. We look forward to welcoming you back soon!

# Frequently Asked Questions

We understand that receiving damaged or defective products can be disappointing, and we're here to assist you every step of the way. Here's how to address common concerns and initiate a damage claim:

## **1.What should I do if my shipment is damaged or products received are defective?**

We're genuinely sorry to hear about any inconvenience caused. Please reach out to us promptly, and our team will prioritize resolving the matter swiftly and effectively. To file a damage claim, follow these steps:

- A. Retain the original box in case a return is required.
- B. Take photos of the damaged box, the damaged part of the item, tracking number, and return label on the box to help us process a replacement or refund.

## **2.Can I return the product if I'm not satisfied?**

While we uphold stringent quality standards and collaborate with experienced manufacturers, we acknowledge that dissatisfaction may arise. If you're still unsatisfied, you can initiate a return within 30 days of receiving the product. Simply message us with your reasons for return, and we'll facilitate the process.