

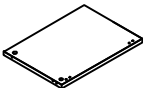

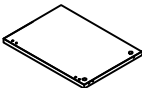

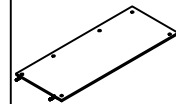

(1) Top  1PC	(2) End Panel  1PC	(3) End Panel  1PC	(4) Modesty Panel  1PC	(A) Dowel  10PCS+1	(B) Cam Pin  10PCS+1	(C) Cam Lock  10PCS+1	(p) Adhesive Cam Cover  4PCS	(D) Leg leveller  2PCS	(W) Grommet  2PCS	STEP 3 
---	---	---	---	---	--	--	---	---	--	---

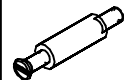

CREDENZA SHELL, 72*20

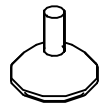
72"W*20"D*29"H

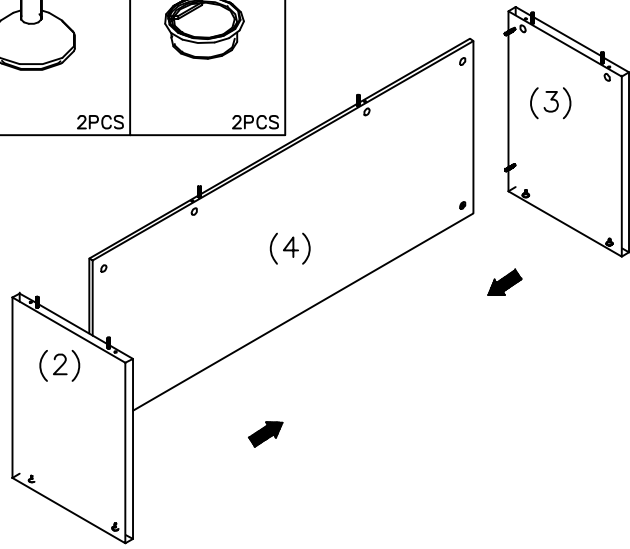
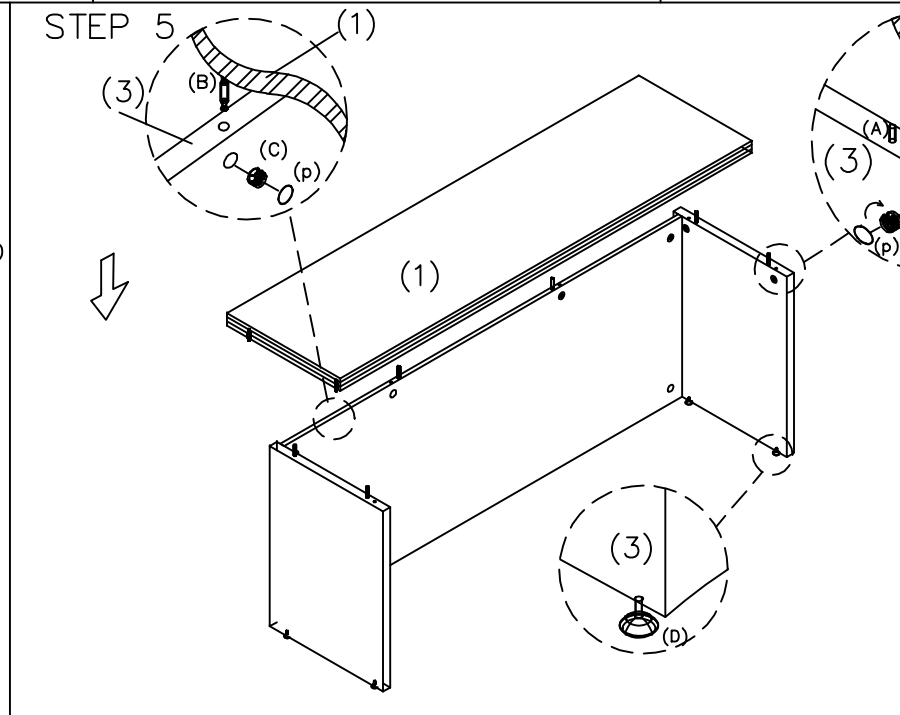
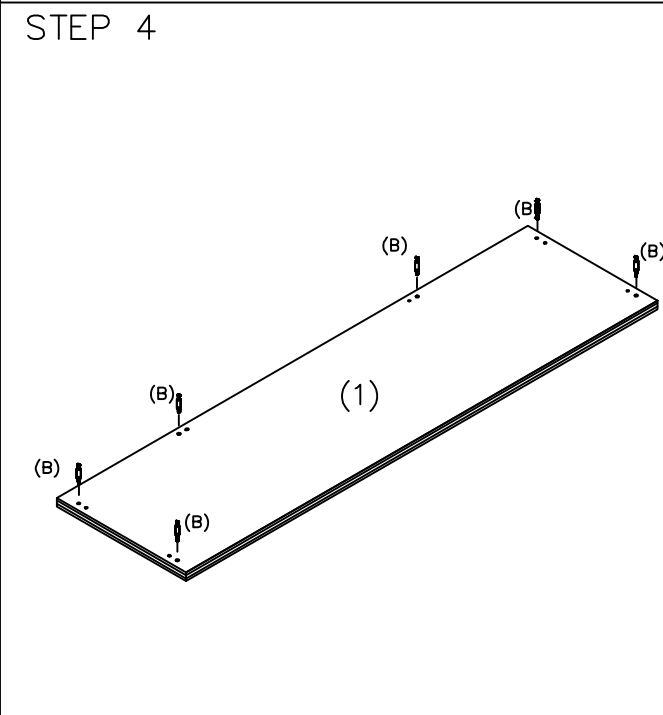
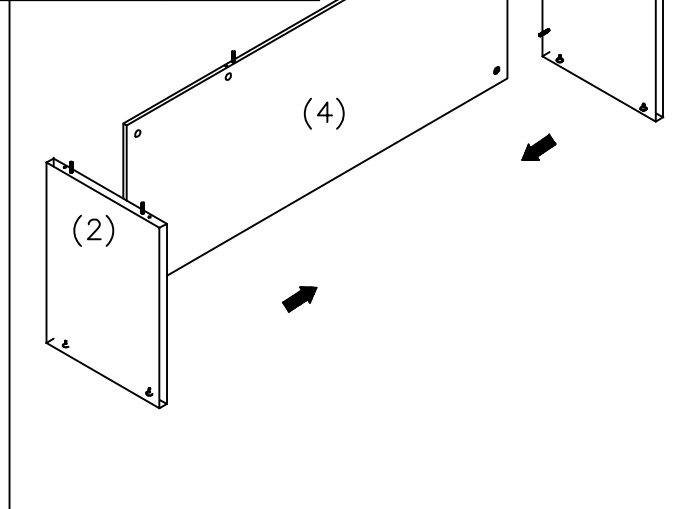
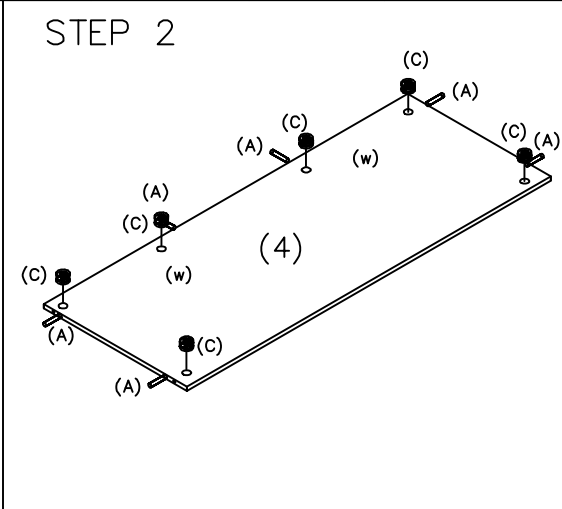
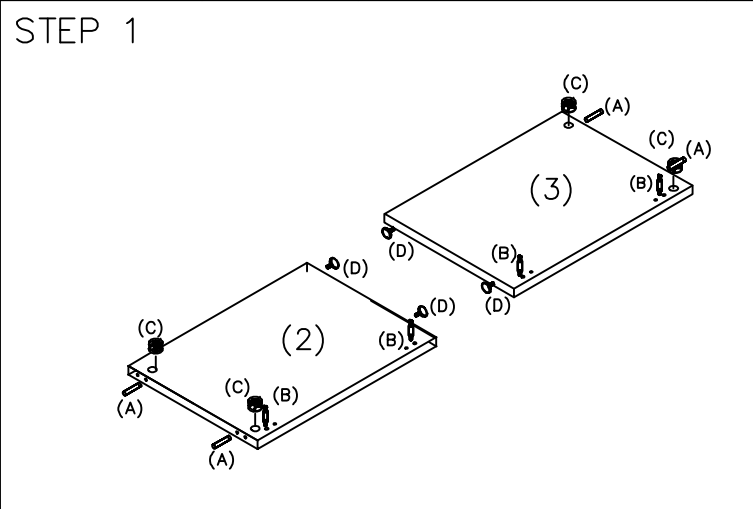
Always lay components on A clean, soft-cushioned surface during assembly.