

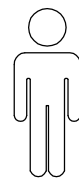

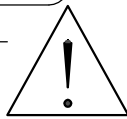

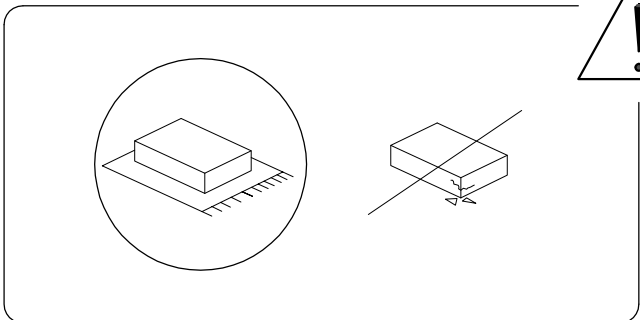

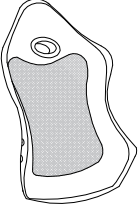
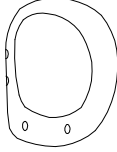

30'

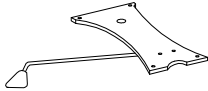
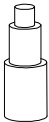
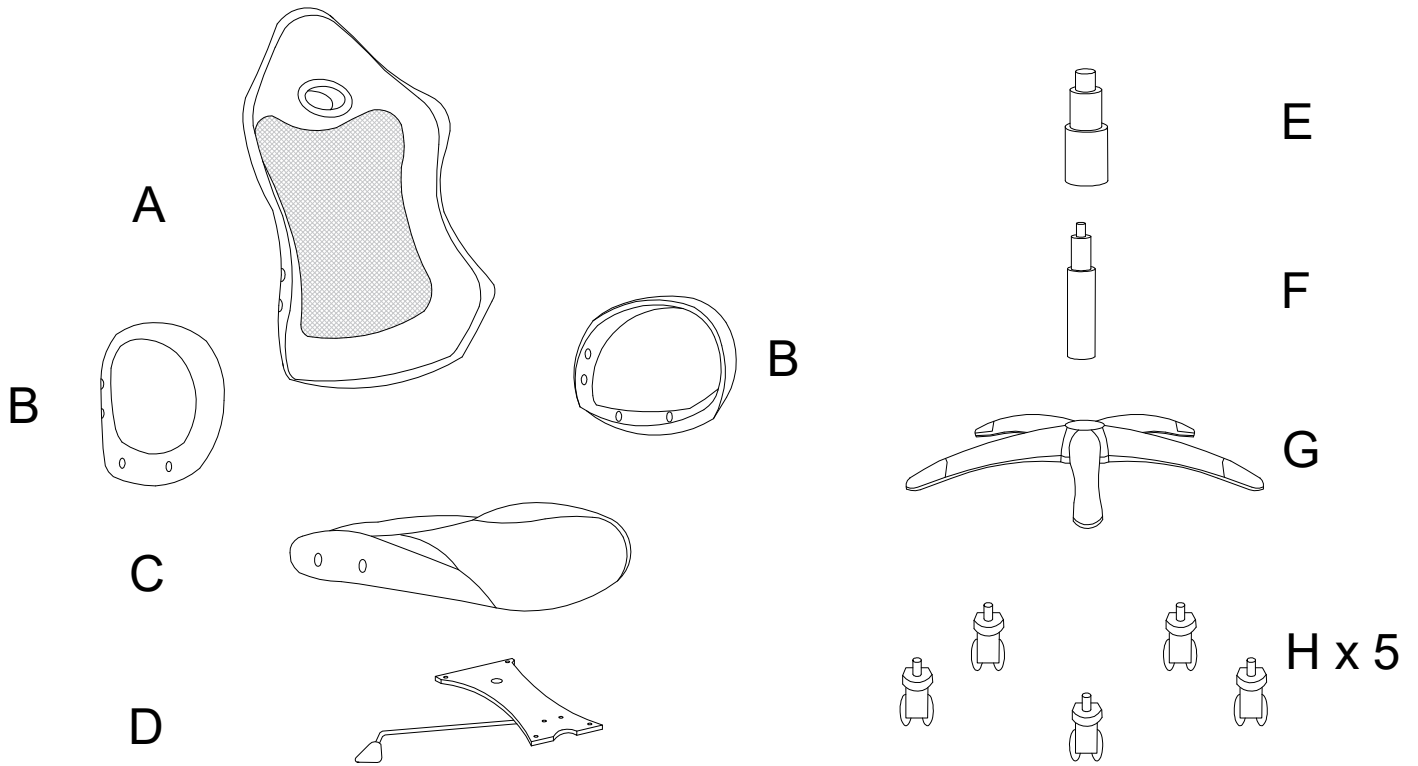

1

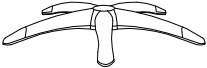
<b>A</b>	<b>B</b>	<b>C</b>	<b>D</b>	<b>E</b>
				
<b>x 1</b>	<b>x 2</b>	<b>x 1</b>	<b>x 1</b>	<b>x 1</b>

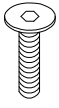
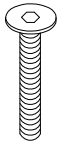
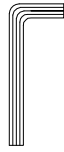

<b>F</b>	<b>G</b>	<b>H</b>	<b>I</b>
			
<b>x 1</b>	<b>x 1</b>	<b>x 5</b>	<b>x 4</b>
<b>J</b>	<b>K</b>	<b>L</b>	<b>M</b>
	 M6 x 22	 M8 x 25	
<b>x 4</b>	<b>x 8</b>	<b>x 4</b>	<b>x 1</b>



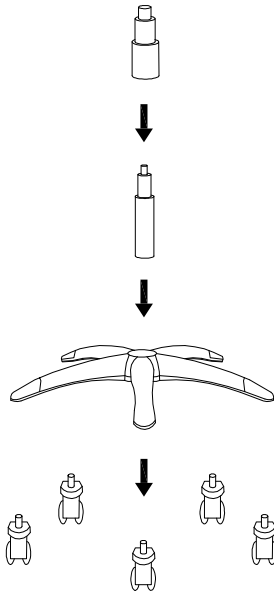
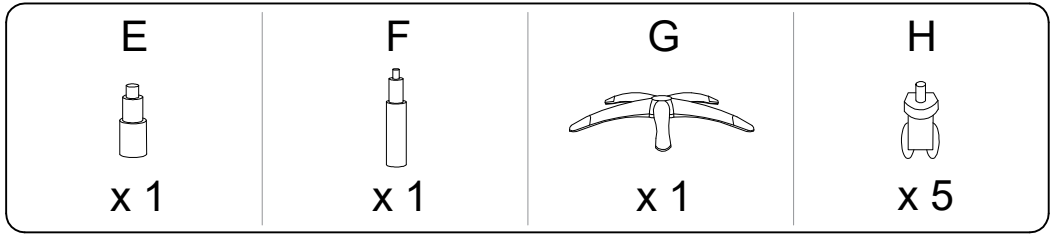

1

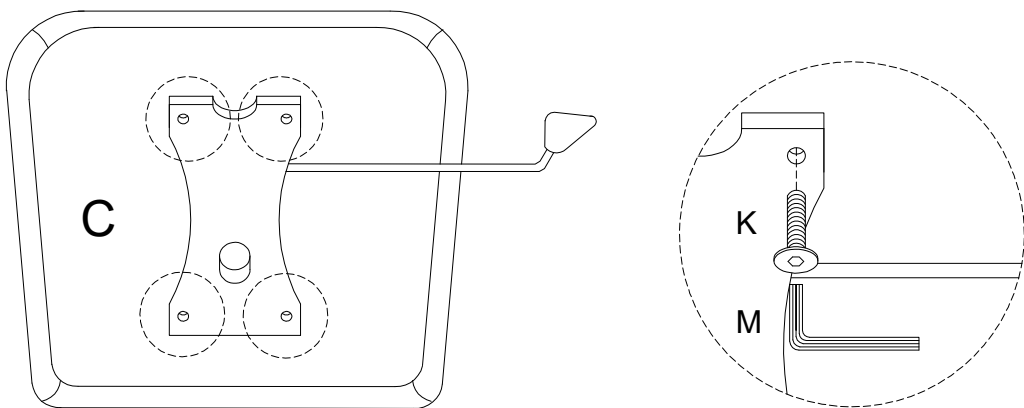
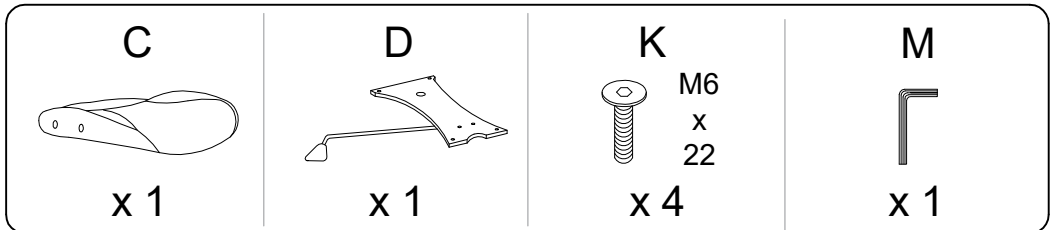

2



3

<b>A</b>  x 1	<b>B</b>  x 2	<b>I</b>  x 4	<b>J</b>  x 4	<b>K</b> M6 x 22 x 4	<b>L</b> M8 x 25 x 4	<b>M</b>  x 1
--	--	--	--	----------------------------------	----------------------------------	--

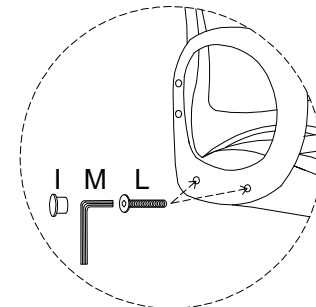
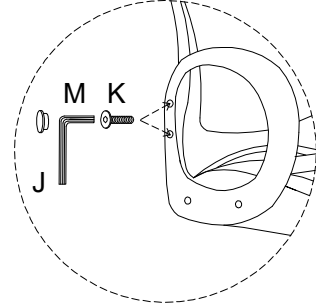
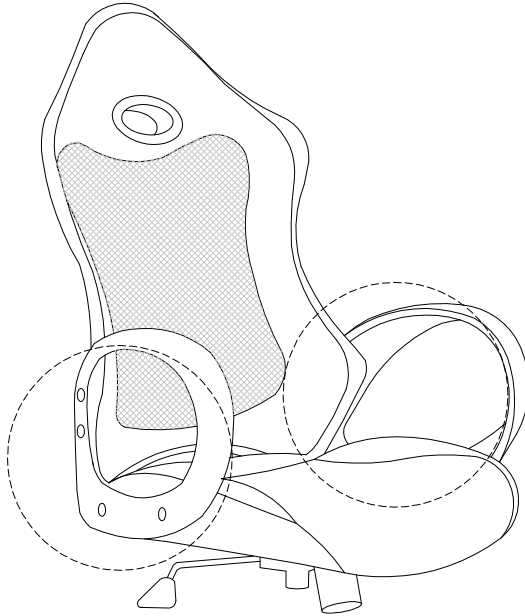

5

