

INSTRUCTION FOR USE

Warm Tips:Ceiling Fan Maintenance

- 1, because the ceiling fan is functioning product, so please regularly check the hanger, blade, leaf frame and various other parts are loose,And timely fastening it to ensure safety.
- 2, regular cleaning of the ceiling fan, only wipe lightly with a soft brush or lint-free cleaning cloth, do not use a damp cloth or other Destructive cleaning agents.
- 3, can not be any part of this product to add oil or lubricant.



Enjoy the natural wind

Please keep this manual.
Be sure to read the instructions for use of this product, install and use this product in accordance with the requirements thereof.

Why us?

1. We've used the professional technology from Taiwan, produced our fan with high efficient, quiet, durable and energy saving motor, and ensure our motors can be guaranteed for 10 years.
2. With the personalized and unique structural design, our fans owned the classic and fashion appearance. We also designed our fans with imported zinc, alloy housings and plywood blade to ensure the high quality.

Warning

1. The input wattage for this fan should be 220V/50HZ.
2. Electrical installation should be performed by a qualified licensed electrician.
3. To reduce the risk of electric shock, ensure electricity has been turned off before assembling or disassembling. The assembling wire order must be Ground wire, hot (supply) wire/neutral wire, and the disassembling wire order should be neutral wire/ hot (supply) wire, ground wire.
4. Make sure all assembled screws were tight during the assembling.
5. To reduce the risk of injury, do not touch the blade when the fan is running.

Tools required for installation

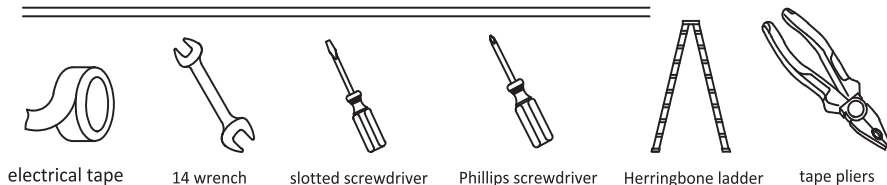

6. Balance adjustment for this "invisible" fan

Statement: The fan was balanced before shipping, but the balance might be affected during the long distance transportation. So please re-balance the fan according to the following steps if you found the fan has got the noticeable wobble problem after your final assembly:

- (1). Take out the balance kit pack from the package, and stick two balance magnet pieces on any one place marked digit shown on Figure 2, and turn on the fan to check if the wobble problem is still noticeable. Repeat this until found the place which will let the wobble problem disappear. (Fig.13)
- (2). Take off the balance magnet pieces and peel a balance kit to stick on instead. (Fig.14)

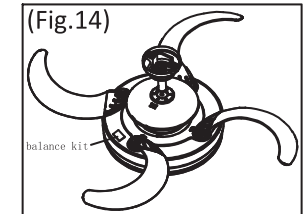
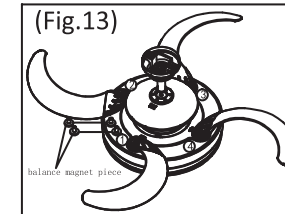
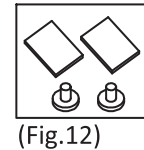

Any questions, please feel free to contact with our distributor or contact with our sales by the phone number shown in our instruction.

(3).Raise up the canopy to the ceiling for covering the mounting bracket(make sure the canopy will seat into the two screws on the bracket), rotate the canopy to ensure the screw head are at the narrow end of the key holes, tighten the screws. (Fig.9)

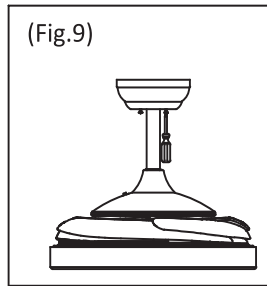

5.Attach the glass

(1).Make sure the key slot on the light glass is in the same line with the key slot on the fan body, then rotate the glass clockwise slightly until the glass is firm. (Fig. 10 & 11)

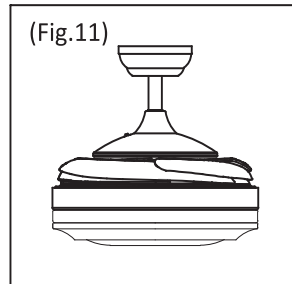
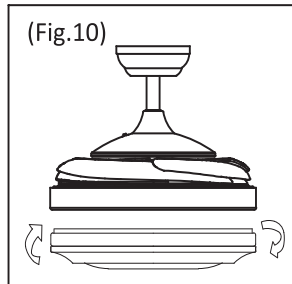

Reading before installation

1.Fan will not start

- (1).Check the wire connections to the fan, ensure they are all correct.
- (2).Check and ensure the input wattage is correct to be 220V/50HZ.

2.Than fan sounds noisy

- (1).Make sure all assembled screws are tight.
- (2).Make sure wire nut connections are not rubbing against each other or the interior wall of the switch housing.

Installation steps and instructions

1.Components list

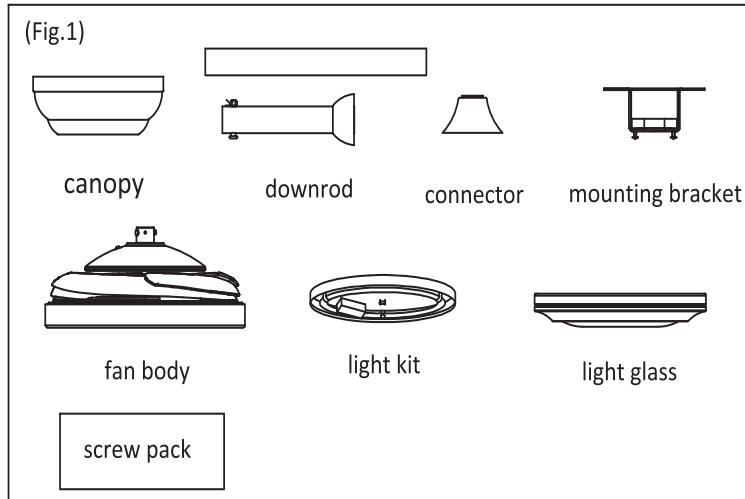

2.Mounting bracket installation

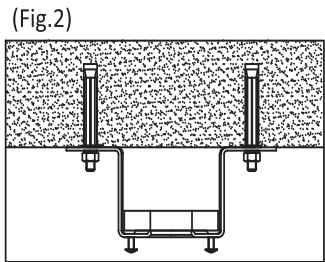

(1). Concrete ceiling: Drill two holes with an appropriate depth by a drilling bit with dia. At 8mm, and insert two pieces expansion screws in the holes, then fix the hanger bracket into the expanding screws with the wood screws and tighten it by the nuts of the expansion screws.(Fig.2)

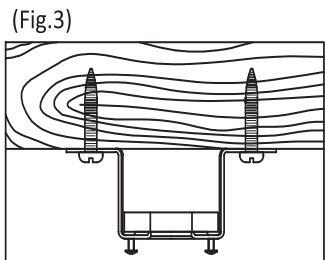

(2).Wood ceiling: Fix the mounting bracket to the wood ceiling with (thickness at 7cm at least) by 4 wood screws. (Fig.3)

3.Light kit installation

(1).Loosen four screws from the bottom of the fan body, and remove one screw put on side for use later. Attached the light kit to the fan body by rotating the light kit until it seat into the three loosened screws on the fan body, then tighten the screws, also screw in the removed screw and tighten it. (Fig.4 & 5)

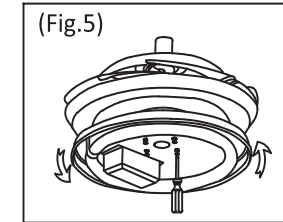
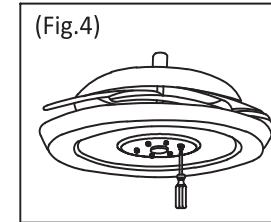

4.Installation of the hanger system

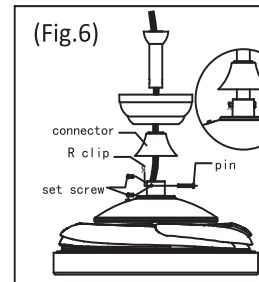

(1).Get off the pin from the downrod by removing the R clip, and get the lead wire through the downrod, canopy and the connector, then seat the downrod into the fan body & rotate the the downrod until the holes on the downrod will match with the holes on the fan body, finally, you should get the pin through the holes and fix the pin by the R clip by another side. (Fig.6)

(2).Place the downrod with hanger ball into the mounting bracket, rotate the motor assemble until the "Check Tab" on the mounting bracket has dropped into the "Registration Slot" on the hanging ball and seat firmly (Fig.7 & 8)

