

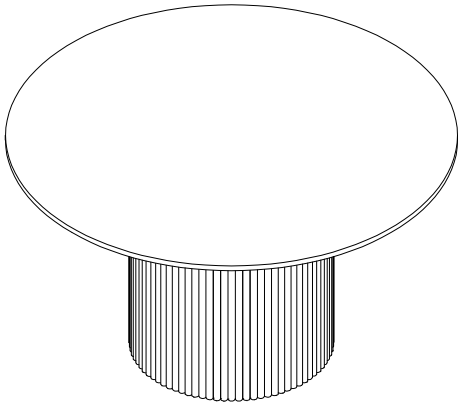

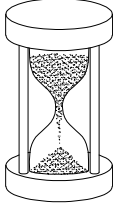

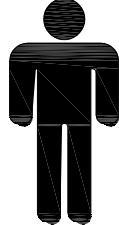

# ASSEMBLY INSTRUCTIONS

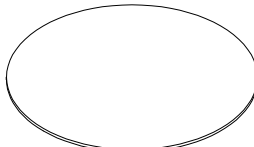

 <b>15 MIN</b>	 <b>x2</b>
--	---

  
**TOOLS REQUIRED**  
 ( Allen Key provided)

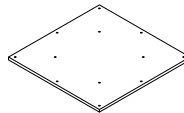
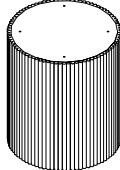

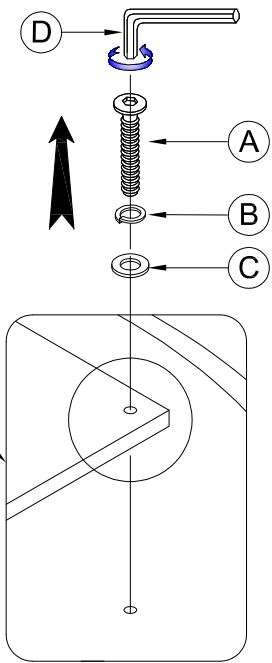
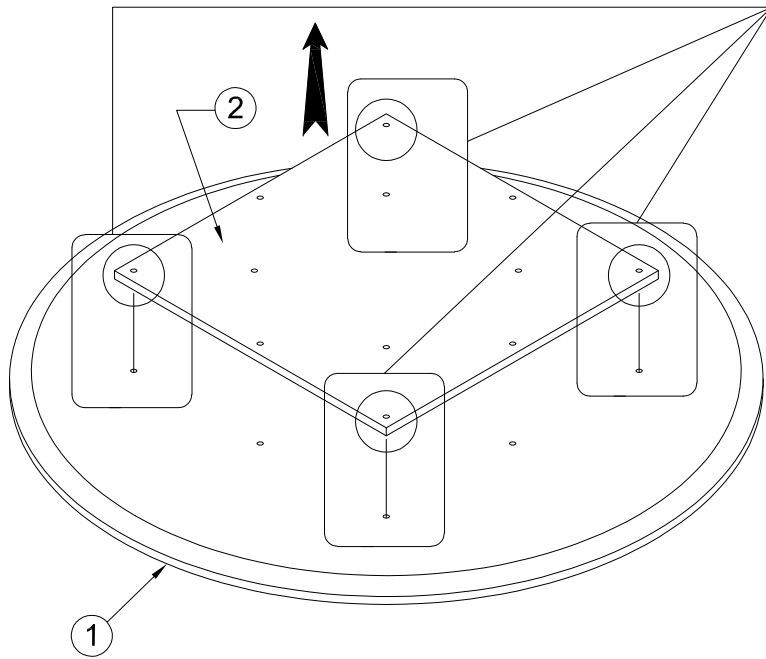

PART		HARDWARE	
①	TABLE TOP x 1PC		(A) M8 x 40 mm: 12 pcs 
			(B) Ø8 x Ø13 x 1.2: 12 pcs 
			(C) Ø8 x Ø22 x 2: 12 pcs 
			(D) 4mm x 50: 1 pc Allen key 
②	MOUNTING PANEL x 1PC		
③	BASE x 1 PC		

## STEP 1

Detach Mounting Panel (Part 2) from table top (Part 1) before assembling the table. Unscrew and remove listed hardware with Allen Key (D) to detach Mounting Panel



Unscrew bolts and hardware from all 4 corners



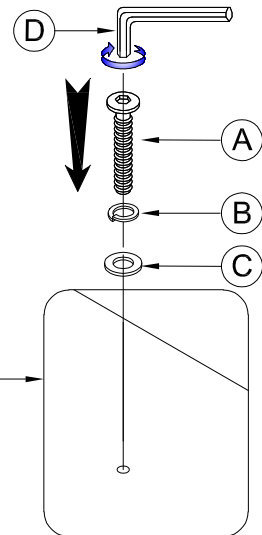
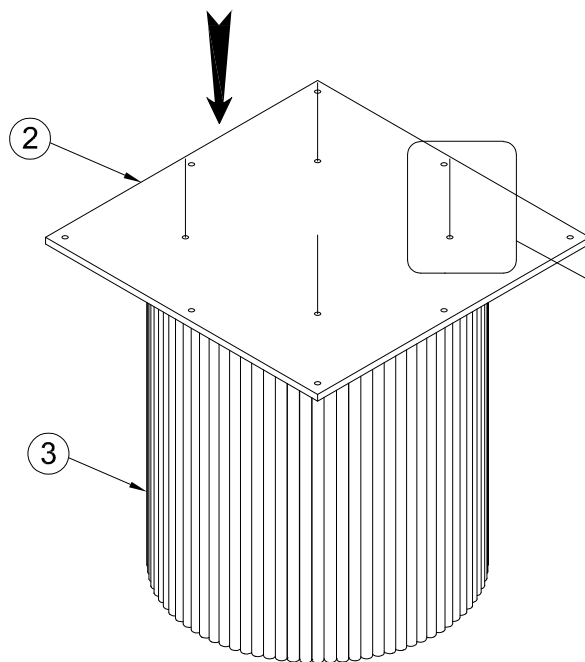

<b>A</b>  M8 x 40 mm: 4 pcs	<b>B</b>  Ø8 x Ø13 x 1.2: 4 pcs	<b>C</b>  Ø8 x Ø22 x 2: 4 pcs	<b>D</b>  4mm x 50: 1 pc
---	--	--	--

## STEP 2

Carefully attach Mounting Panel (Part 2) on the Base (Part 3) and secure with corresponding hardware.



Secure and screw all 4 corners with hardware



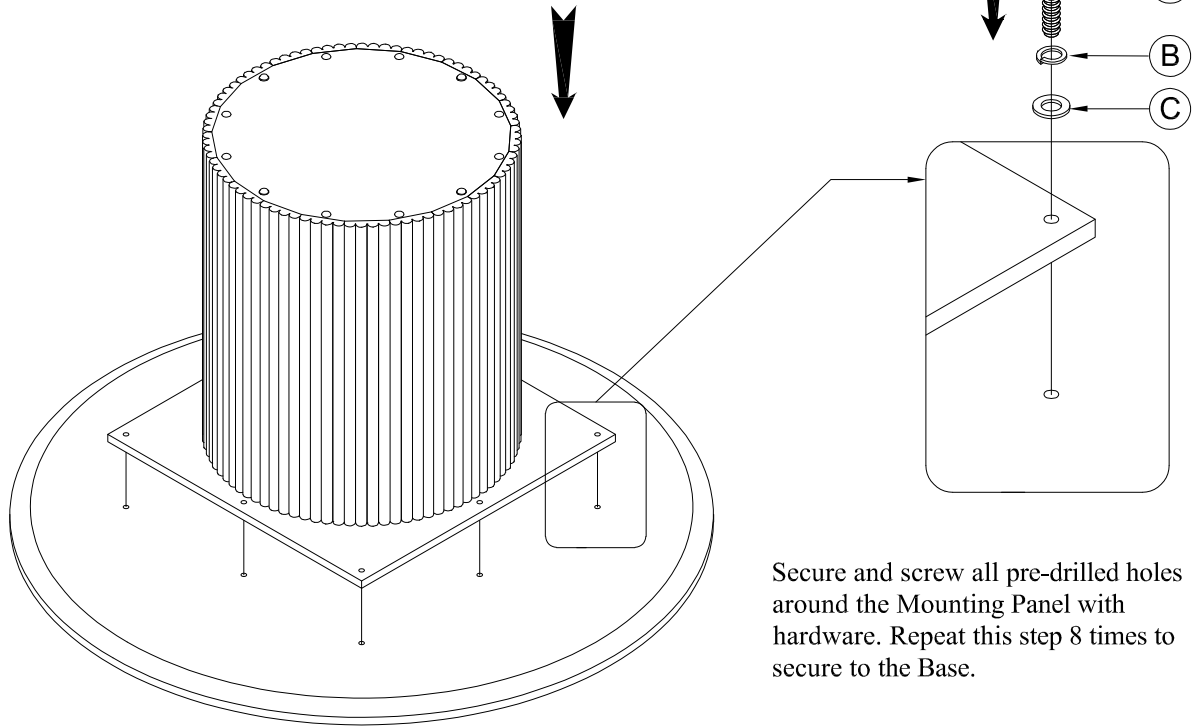

<b>A</b>  M8 x 40 mm: 4 pcs	<b>B</b>  Ø8 x Ø13 x 1.2: 4 pcs	<b>C</b>  Ø8 x Ø22 x 2: 4 pcs	<b>D</b>  4mm x 50: 1 pc
---	--	--	---

### STEP 3

Flip base and align Mounted panel to the Table Top holes.  
Secure the Base to the Table Top with corresponding screws as show in the image



Secure and screw all pre-drilled holes around the Mounting Panel with hardware. Repeat this step 8 times to secure to the Base.

<b>A</b>  M8 x 40 mm: 8 pcs	<b>B</b>  Ø8 x Ø13 x 1.2: 8 pcs	<b>C</b>  Ø8 x Ø22 x 2: 8 pcs	<b>D</b>  4mm x 50: 1 pc
---	--	--	---

## ASSEMBLY COMPLETE

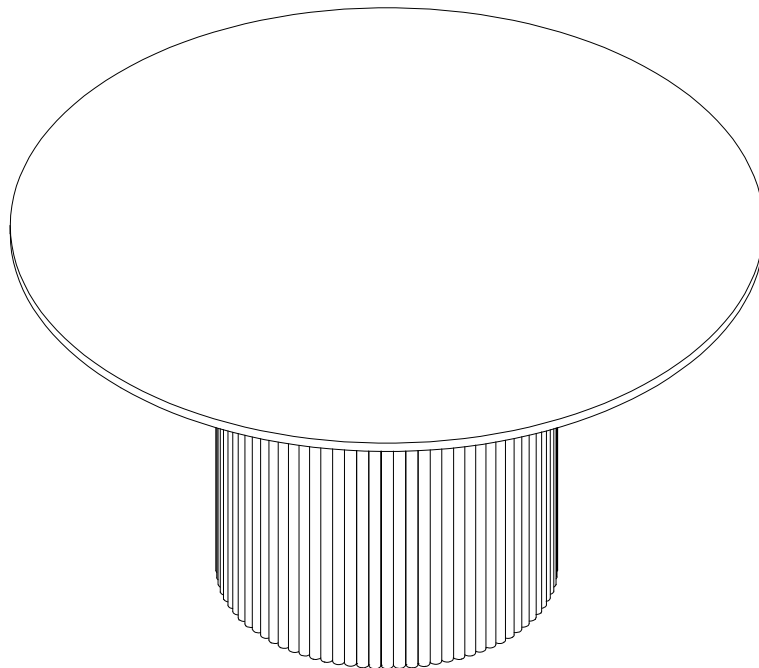

**CAUTION ! : REQUIRES TWO ADULTS TO FLIP AND TURN TABLE UPRIGHT AFTER ASSEMBLY IS FINISHED.**