

Metal Garden Shed

OWNER'S MANUAL

Size 6 Ft X 4 Ft



Tall walk in Shed

Quick & Easy Assembly

Ridge Reinforced walls

Wide Double Doors









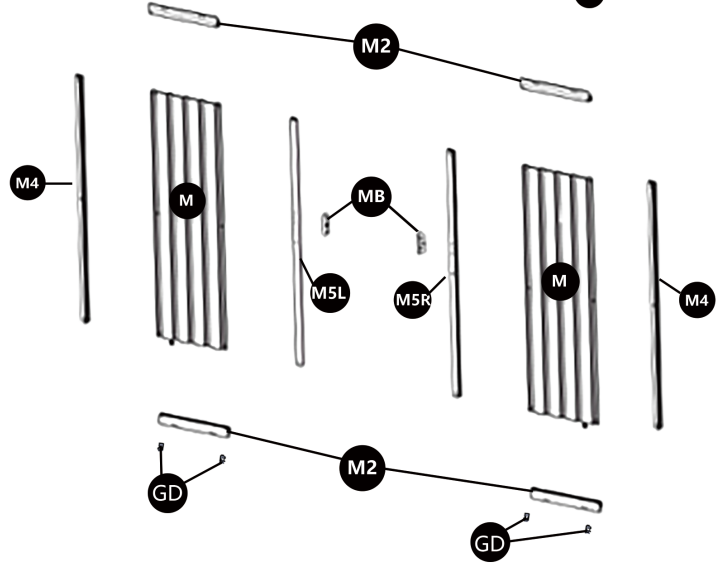
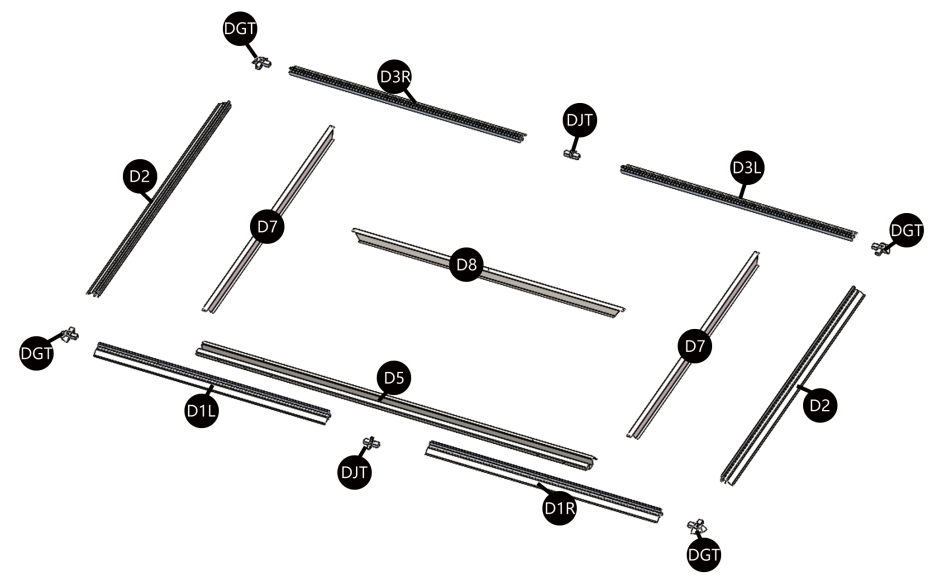
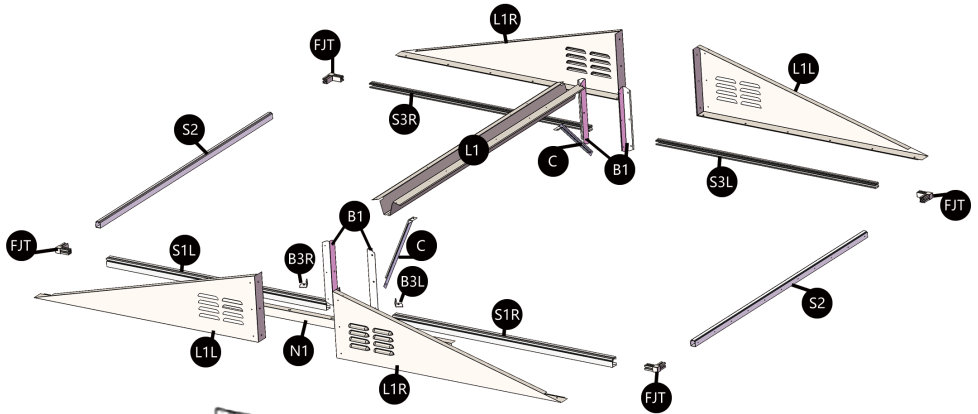
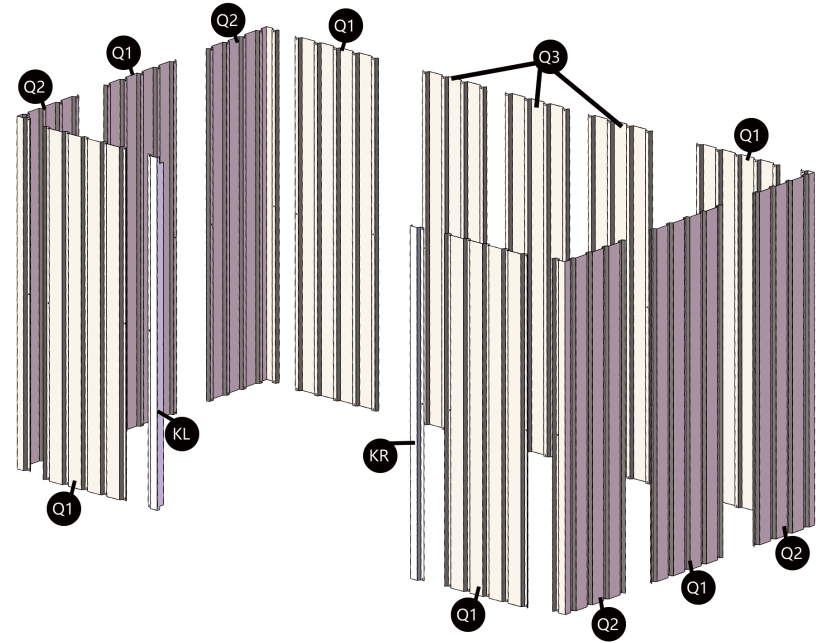
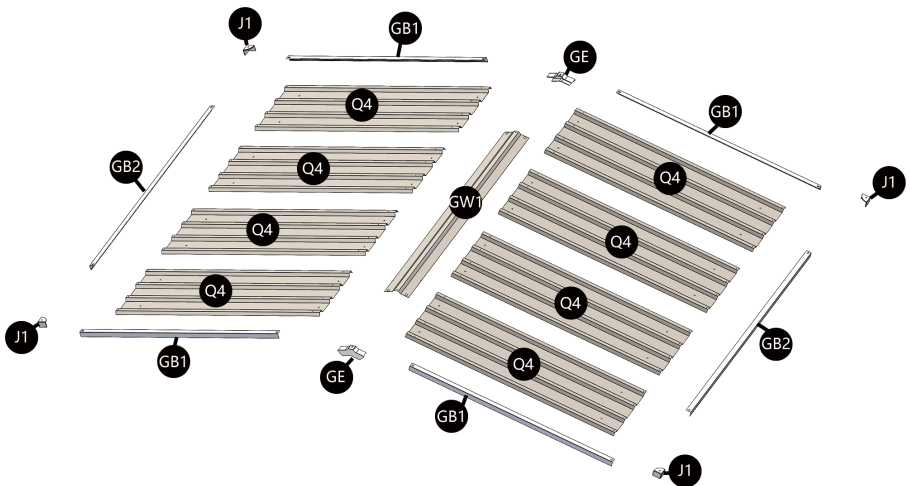

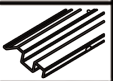

Available in Various Sizes

Take care of sharp edges;

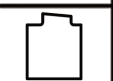

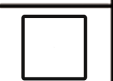



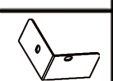



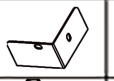





Please wear gloves;















It will take 2 people 2 - 3 hours to install.



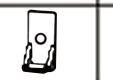

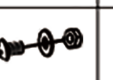
NO1	PART	QTY
D1L		1
D1R		1
D2		2
D3L		1
D3R		1
D5		1
S1R		1
S1L		1
S2		2
S3L		1
S3R		1
KL		1
KR		1
L1L		2
L1R		2
B3L		1

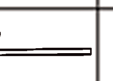
PARTS LIST

NO1	PART	QTY
B3R		1
B1		4
C		2
L1		1
GB1		4
GB2		2
GW1		1
M2		4
M4		2
M5L		1
M5R		1
Q1		6
Q2		4
Q3		3
Q4		8
M		2

NO1	PART	QTY
N1		1
J1		4
MB		2
FJT		4
DGT		4
DJT		2
ZJT		2
GE		2
G2		4
GD		4
F1		232
F3		6
F4		12
F8		4
F11		14

PARTS LIST

NO1	PART	QTY
D7		2
LSM		30
F14		200

NO1	PART	QTY
D8		1

Install LSM at screw exposure, Prevent collisions.
This part is used with all screws, Such as F1 and F3, located in the external tool room Easy to seal and waterproof.

Warning & Attention:

-Take care of sharp edges; Please wear gloves;

-You are advised to read the whole procedure before installing it;

-Try to assemble this product on the flat ground, otherwise it is difficult to carry out;

-It would be much easier to assemble the product with three or more people;

-All panels are clearly marked and care should be taken to use the correct one. It is important that these instructions are followed step by step;

Each screw has a surplus quantity, which can be used in reserve

-After assembly, please check whether all screws are tightened, to prevent parts from falling apart.

Tools:



Gloves



Ladder



Electric drill



Phillips screwdriver



Safety Helmet Hat



goggles

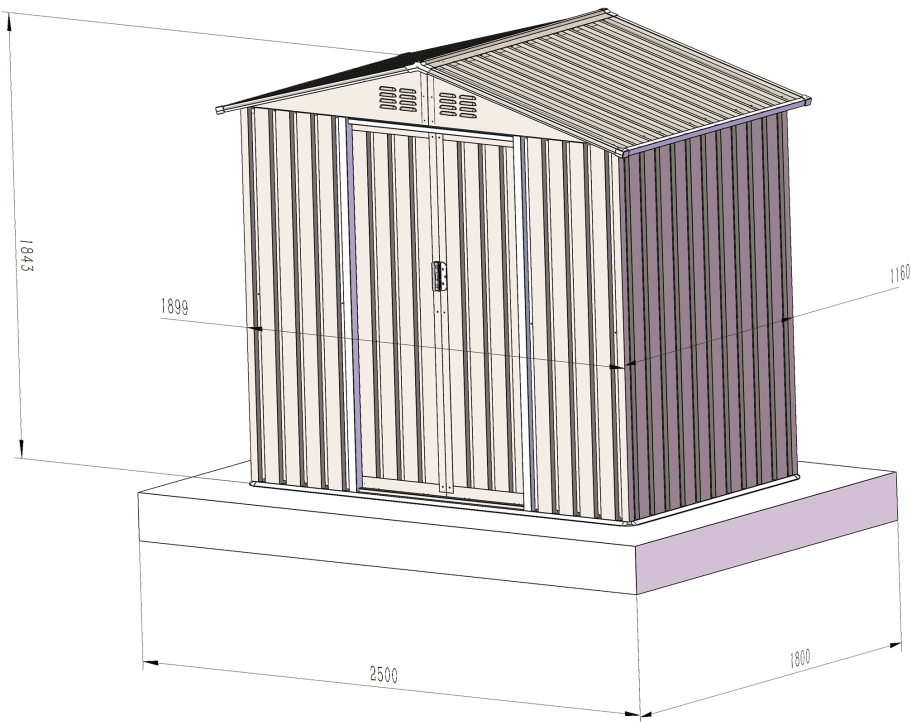

! Note: Take care of sharp edges.
All panels are clearly marked and care should be taken to use the bcorrect one. It is important that these instructions are followed step by step.

NO.	PART	Qty.	NO.	PART	Qty.	NO.	PART	Qty.	NO.	PART	Qty.
D1R		1	D3R		1	DGT		4	F1		12
D1L		1	D3L		1	F14		12	F8		4
D2		2	DJT		2	Tip: All F14s are used with screws. The following steps are not repeated.					

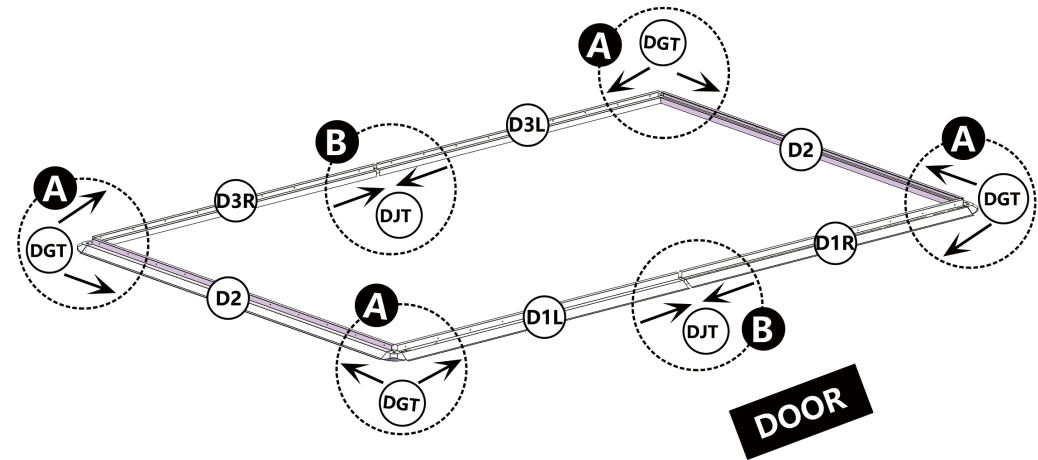

Notice:
DJT installation: At the junction of two arrows, please install in the direction indicated by the arrows (→←).
DGT installation: Two ground pallets are connected to the DGT as shown in the figure.
Each DGT needs to be fixed with two F1s.
F8 installation: After the overall installation is complete, in the case of mud floor, F8 is installed into the DGT hole, as shown in Figure 1. Use expansion screws to install other floors.

! The installation space should be flat, and at least 2500x1800mm. The foundation is fixed on the ground in this space.

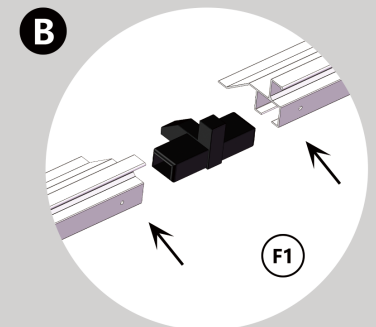
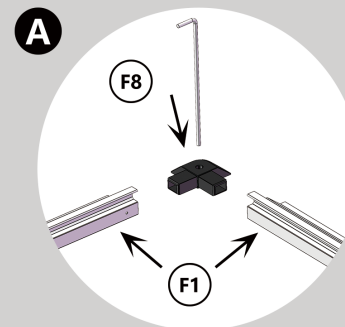



Note: Please wear gloves

NO.	PART	Qty.
D5		1

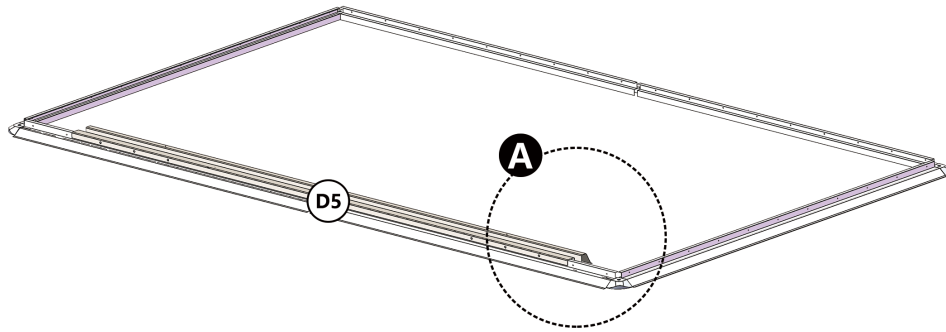

Notice:

You do not need to install screws in this step. Align the holes, which are the same as in the previous step.

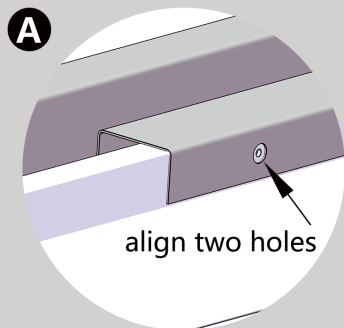

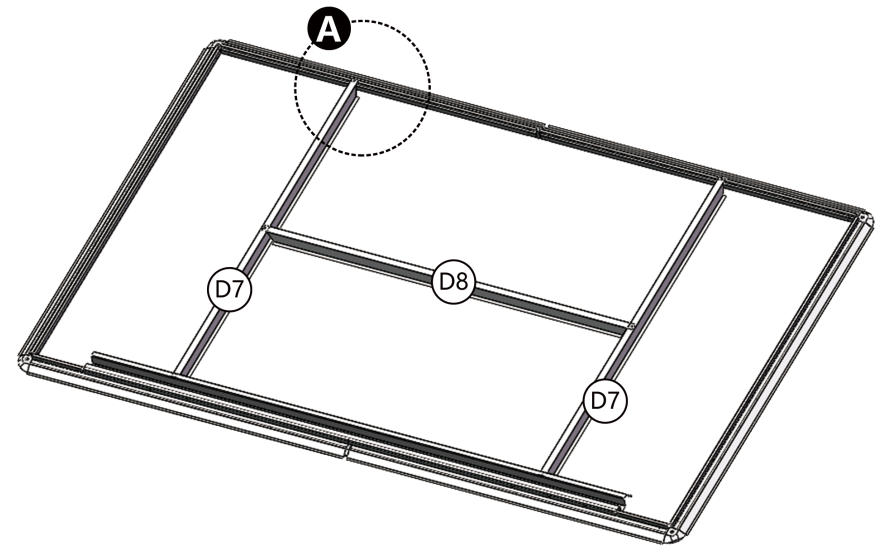

NO.	PART	Qty.
D7		2
D8		1
F1		6

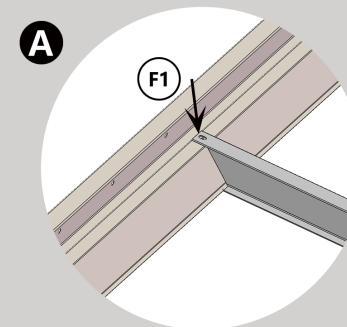

Notice:

As shown in the picture, fix the D7 and D8 ends to the installed ground frame with F1.





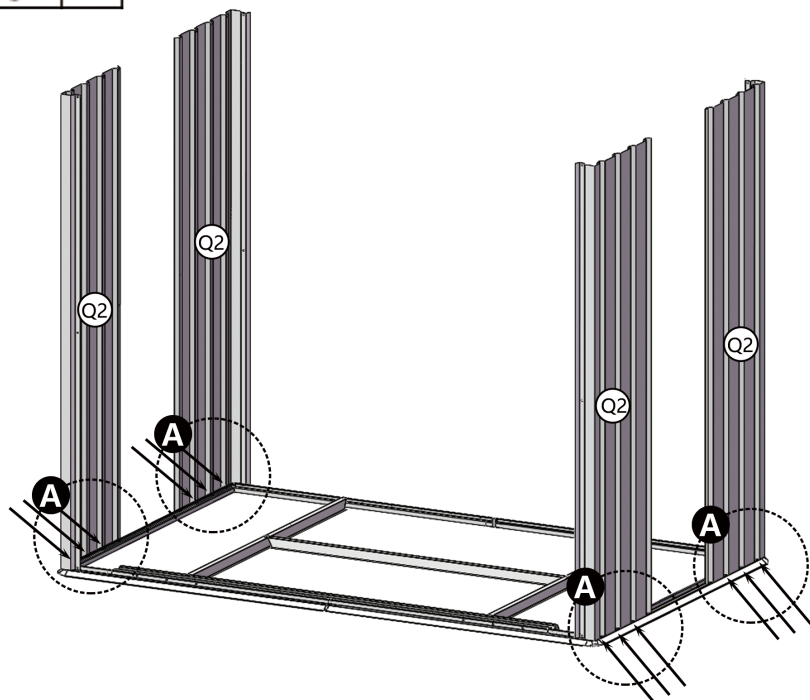



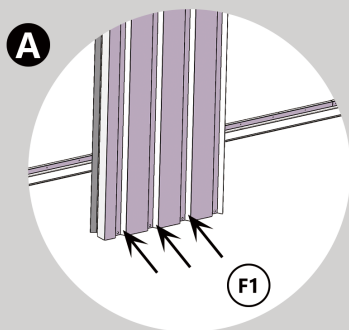

NO.	PART	Qty.
Q2		4
F1		12



Notice:

In this step, only the three holes in the middle of Q2 need to be installed and reserved on both sides. The reserved holes are shared with the following steps.





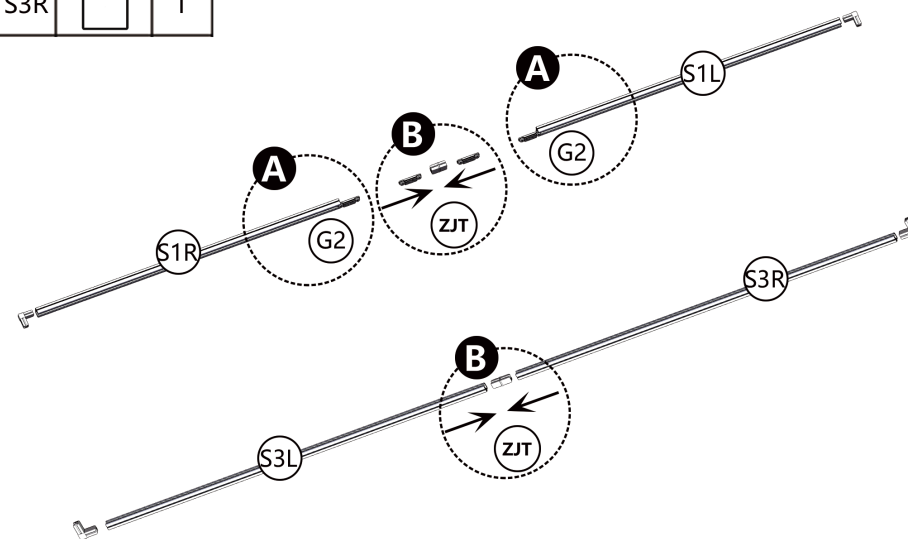

NO.	PART	Qty.	NO.	PART	Qty.
S1R		1	G2		4
S1L		1	F1		4
S3L		1	ZJT		2
S3R		1			

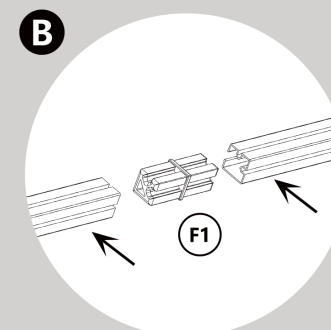
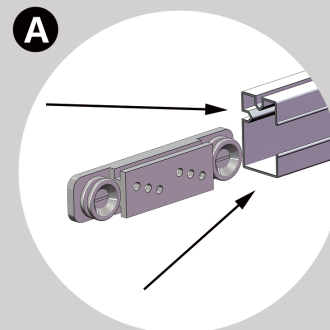

Notice:

G2 has been placed in S1R and S1L before shipment. If it slides out, follow step A to insert it. S1L and S1R, S3L and S3R, are connected by ZJT and fixed by F1, respectively.



NO.	PART	Qty.	NO.	PART	Qty.
S2		2	FJT		4
N1		1	F1		8

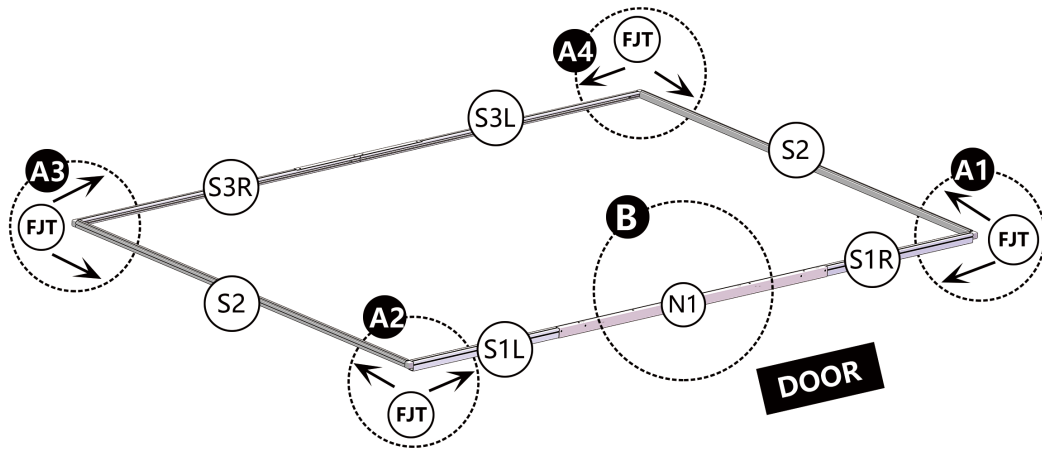
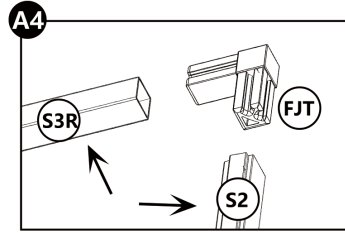
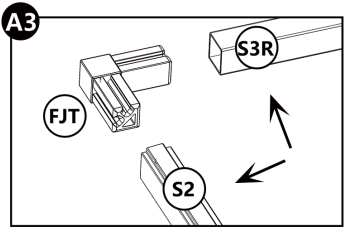

Notice:
 FJT installation: Connect the two frames to the FJT as shown. Each FJT needs to be fixed with two F1s.
 S1L and S1R do not have fixed hole positions.
 N1 installation: Install the N1 on the connected S1R and S1L, and fix it from the bottom up with 2 F1s.

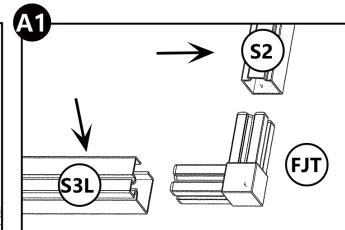
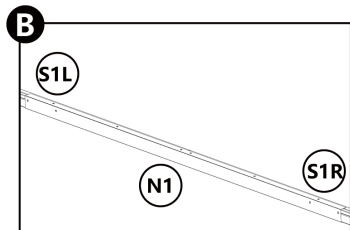
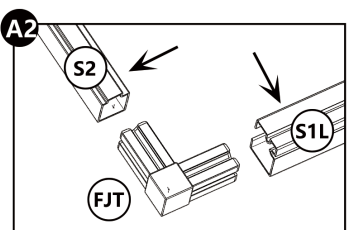

NO.	PART	Qty.
F1		12

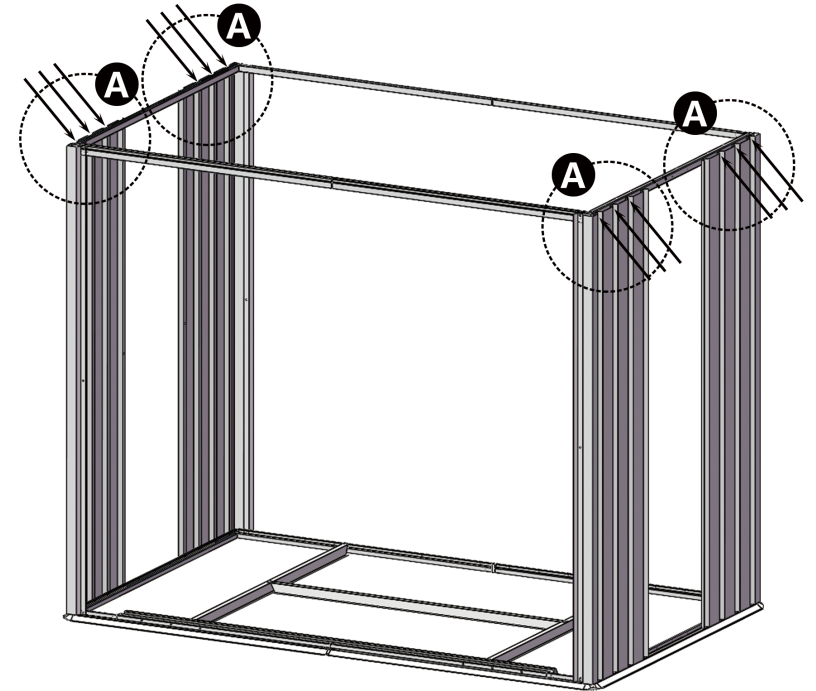

Notice:
 In this step, only the middle three holes need to be installed, and both sides need to be reserved.
 The reserved hole is shared with other steps.
 The walls are tiled on the outside and framed on the inside

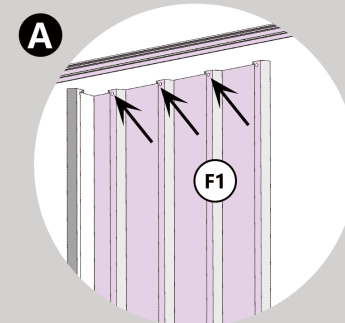

NO.	PART	Qty.
Q1		6
Q3		3
F11		12
F1		88

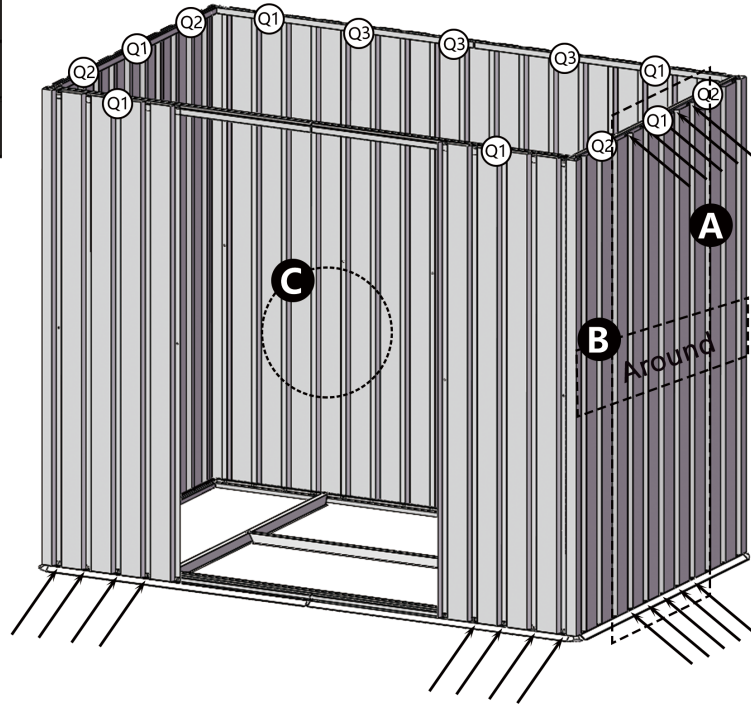

Notice:
 As shown in the picture, assemble the wall tiles in turn, Q1\Q3, The top, middle and bottom of the wall tiles need to be screwed,
 The upper and lower ends are fixed with F1, and the middle is fixed with F11.

NO.	PART	Qty.
KL		1
KR		1
F1		4
F11		2

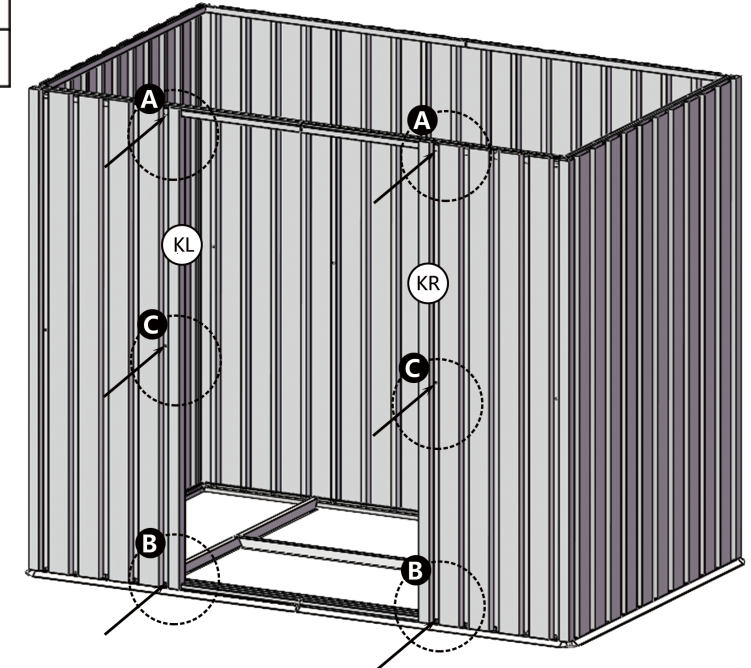

Notice:
 As shown in the picture, the steps of door frame and wall tile installation are the same.
 The upper, middle and lower parts of KR and KL need screws.
 The upper and lower ends are fixed with F1, and the middle is fixed with F11.

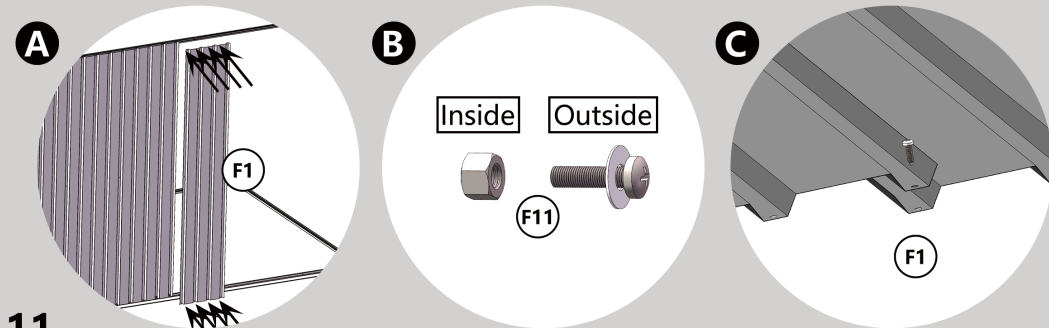

11

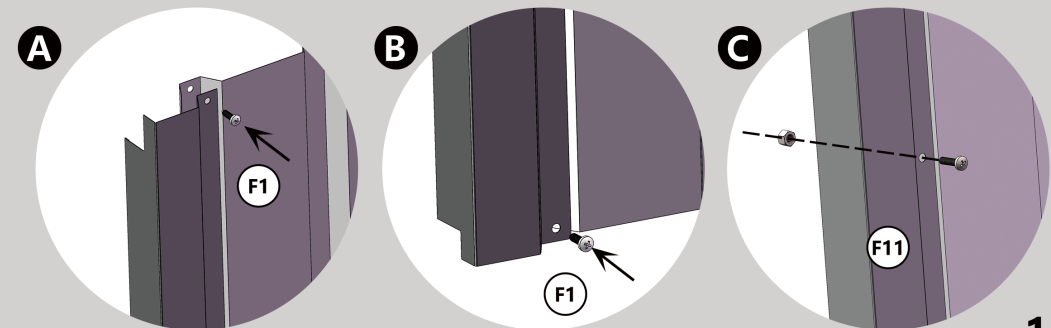

12

NO.	PART	Qty.	NO.	PART	Qty.
B1		4	F3		2
L1L		2	F1		6
L1R		2			

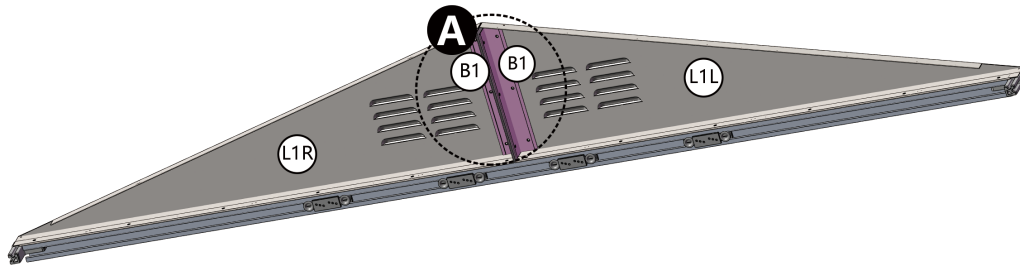

Notice:
 B1 has holes on both sides, and the large holes are 2 B1s, L1R and L1L connected together.
 There are 2 B1s connected to L1R and L1L respectively.

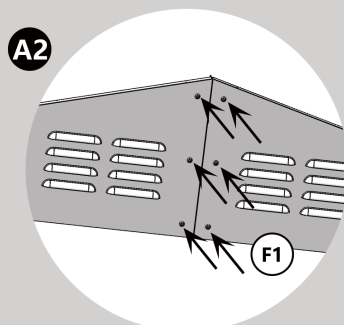
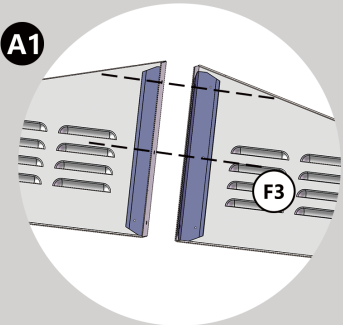

NO.	PART	Qty.
C		2
F3		2
B3R		1
B3L		1

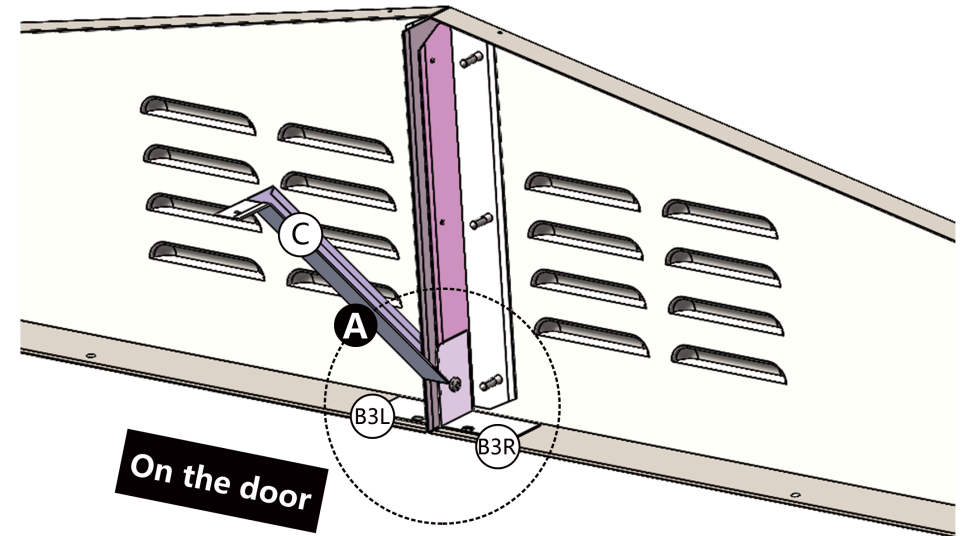

Notice:
 Connect C with 2 B1, L1L, L1R, B3L and B3R and fix them with F3;
 After completing step A, bend the other end of C about 45° and connect it to the bottom of L1
 Special note: B3L and B3R are only on the door, not behind the door.

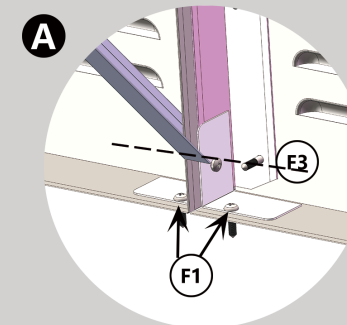

NO.	PART	Qty.
F1		24

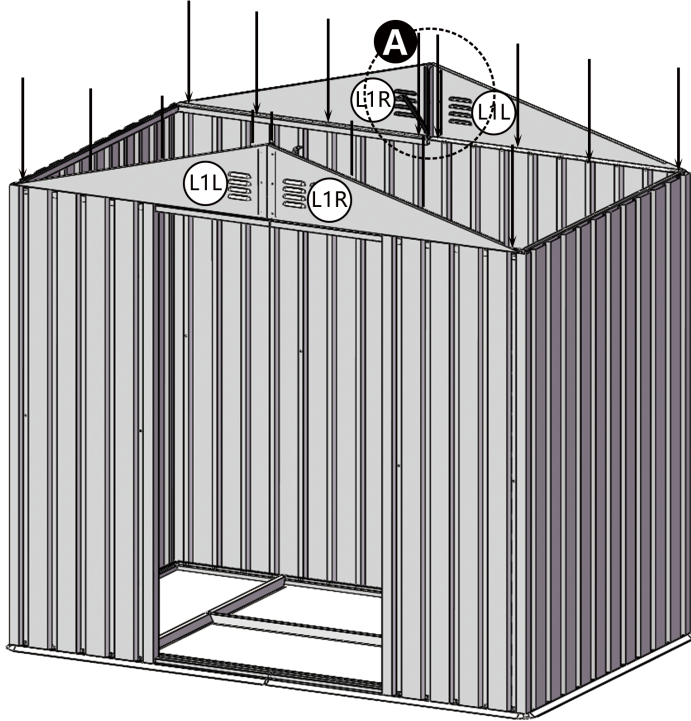

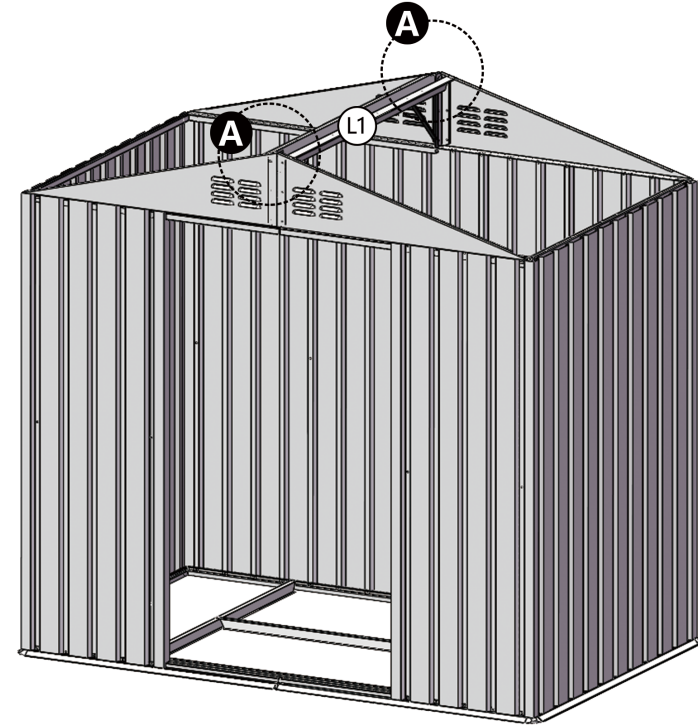

Notice:
The assembled roof support parts are successively installed on the wall tiles with F1

NO.	PART	Qty.	NO.	PART	Qty.
L1		1	F1		2

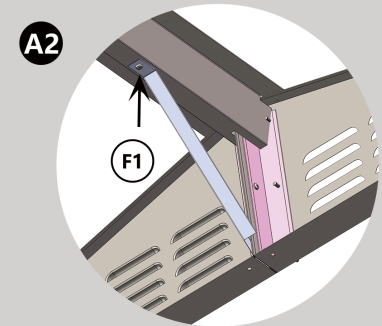
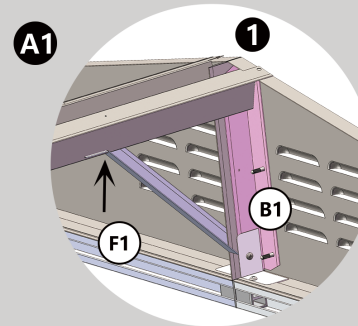
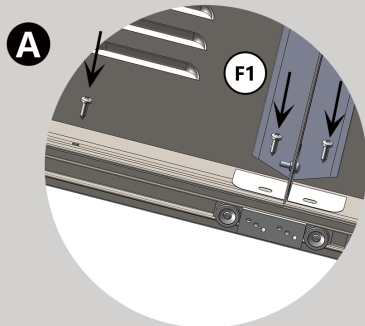

Notice:
Put L1 on L1R and L1L. Position 1 needs to be temporarily installed. This hole is shared with Q4.
To install Q4 needs to be removed and re-fixed. The other end of C needs to be connected to the L1 hole.



NO.	PART	Qty.
Q4		8
F1		32

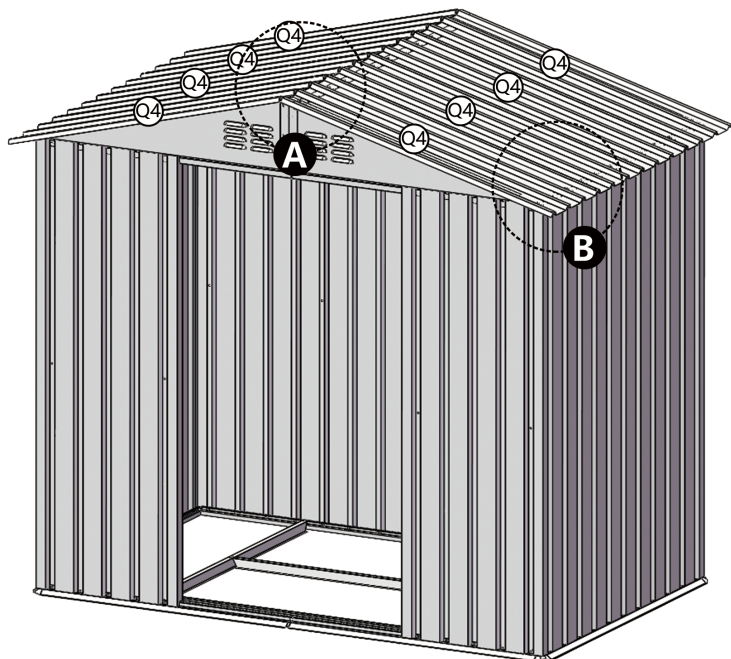

Notice:
Install Q4 in sequence, overlap between every 2 pieces, and each Q4 needs 2 rows of F1 fixed.

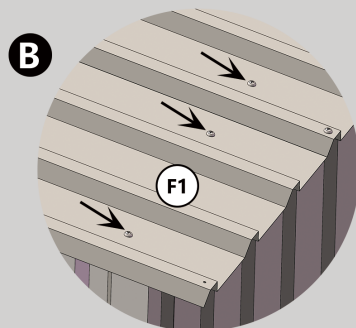
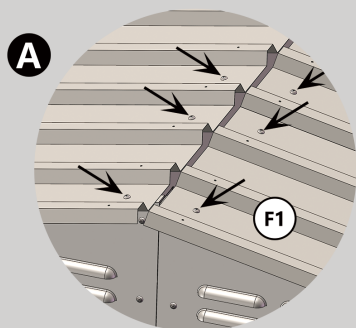

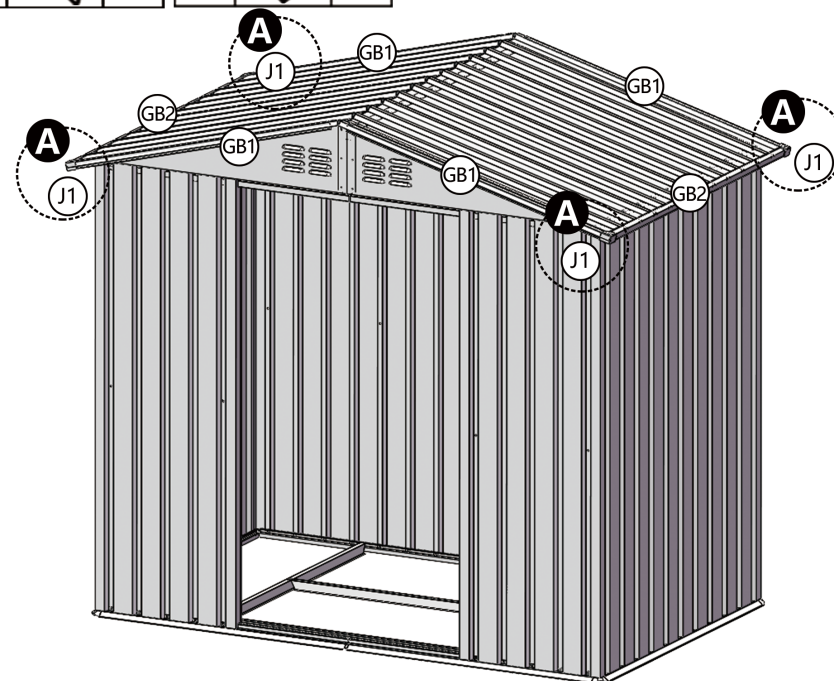

NO.	PART	Qty.	NO.	PART	Qty.
GB1		4	F1		6
GB2		2	J1		4

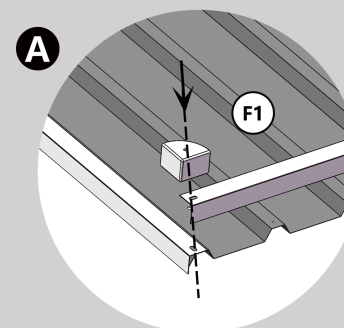

Notice:
As shown in the picture, fix GB1 and GB2 with F1 on the edge,
The four corners GB1, GB2, J1 share the hole position.



NO.	PART	Qty.
GW1		1
GE		2
F1		2

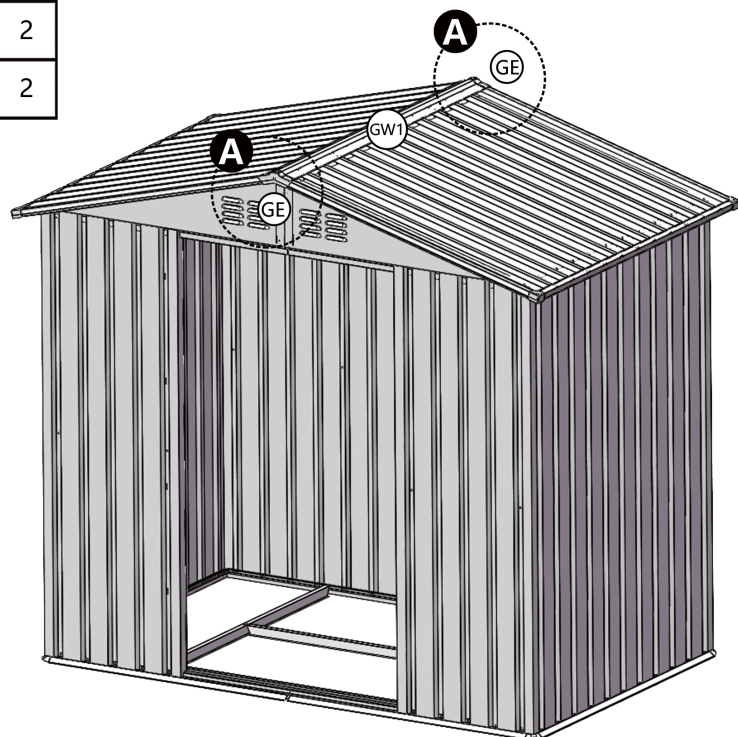







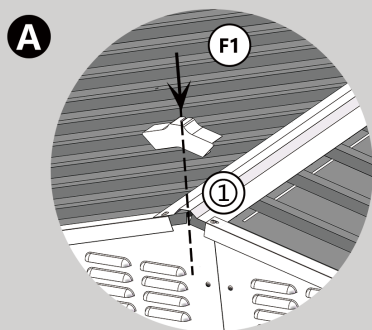



Notice:

Put the GW1 on the roof, install it with the GE, and fasten it at both ends with F1.

① Description :GW1, Q4, GB1 share side holes.



NO.	PART	Qty.	NO.	PART	Qty.	NO.	PART	Qty.	NO.	PART	Qty.
M2		4	M5L		1	GD		4	F3		4
M		2	M5R		1	F1		6			
M4		2	MB		2	F4		12			

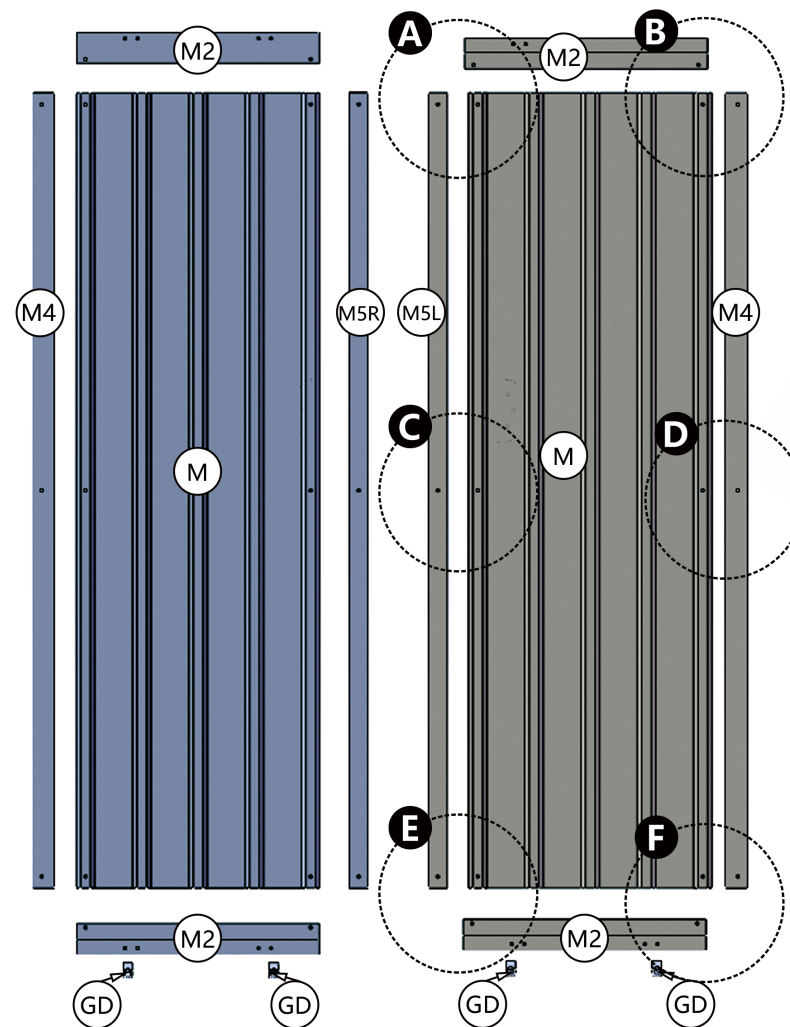

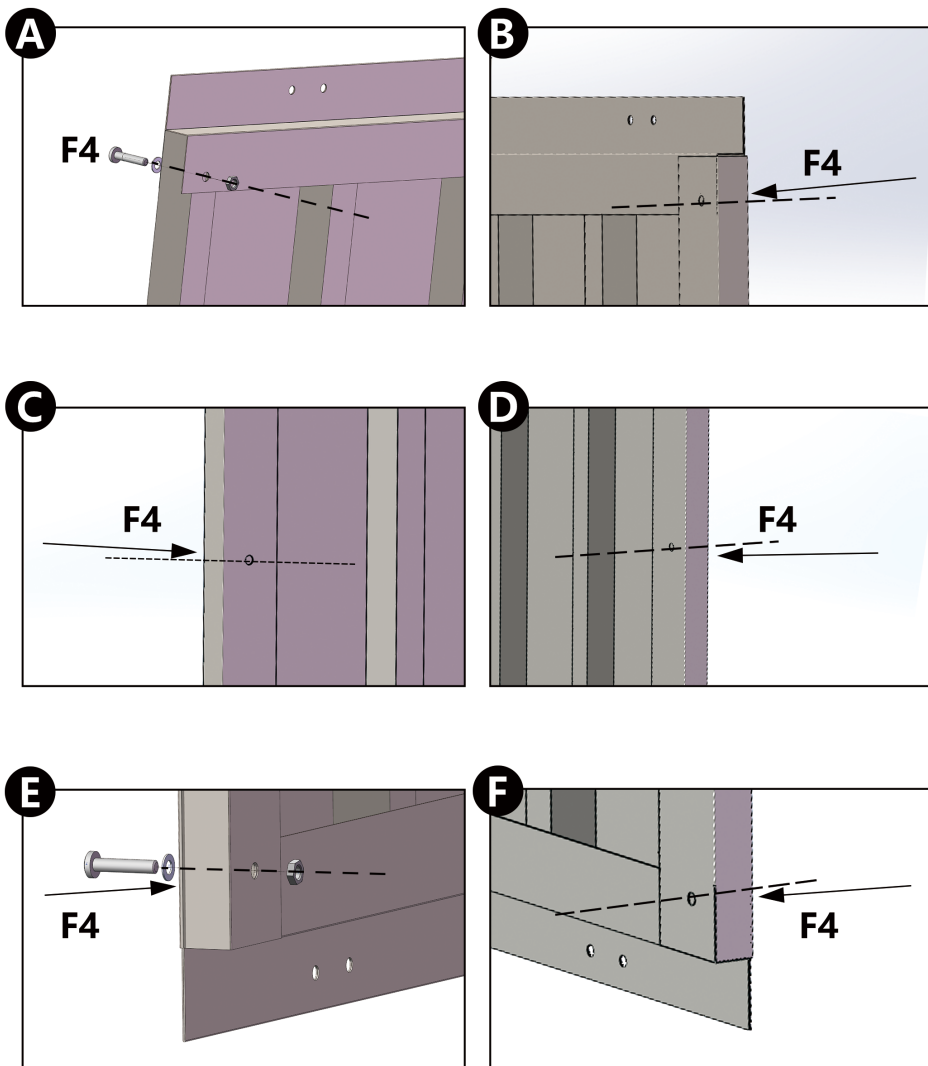

Notice:
The F4 in the picture is fixed from the outside

NO.	PART	Qty.
F1		3
F3		2
F4		6

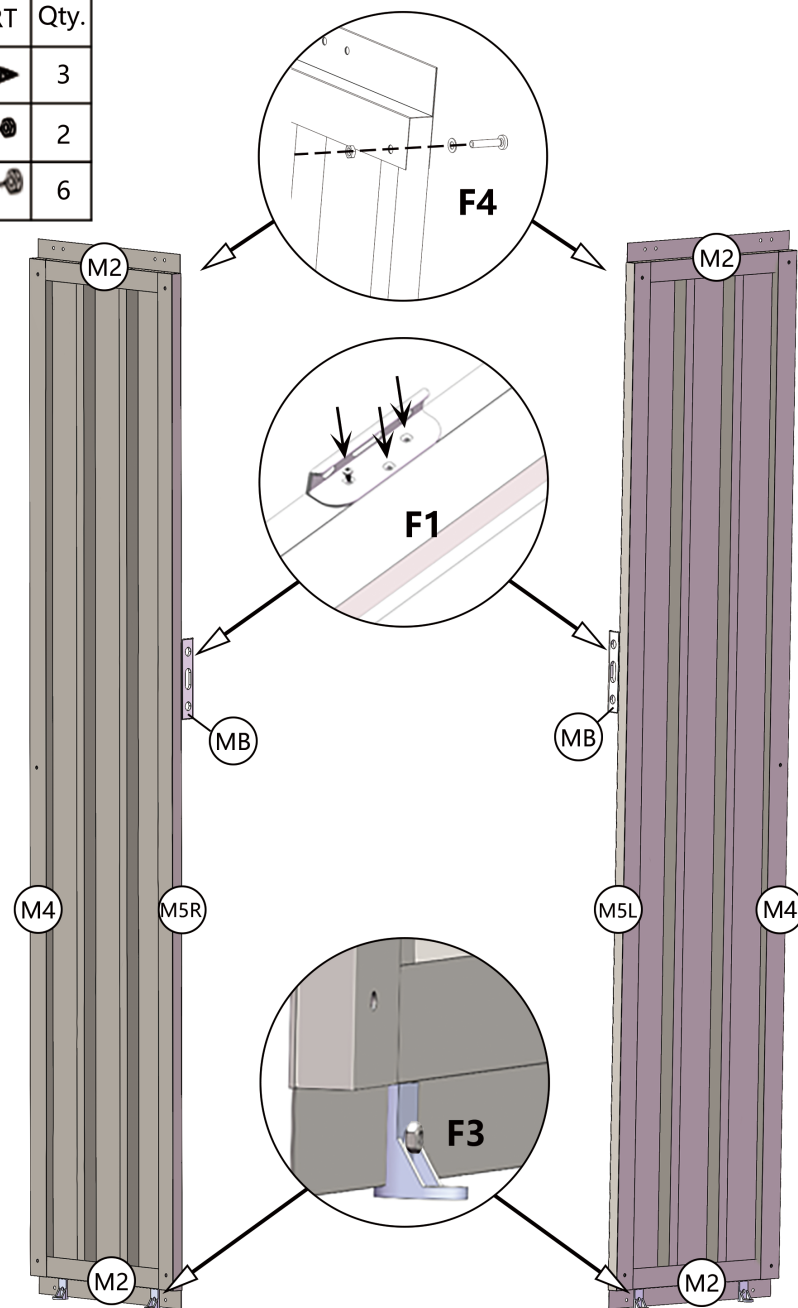

NO.	PART	Qty.
F1		8

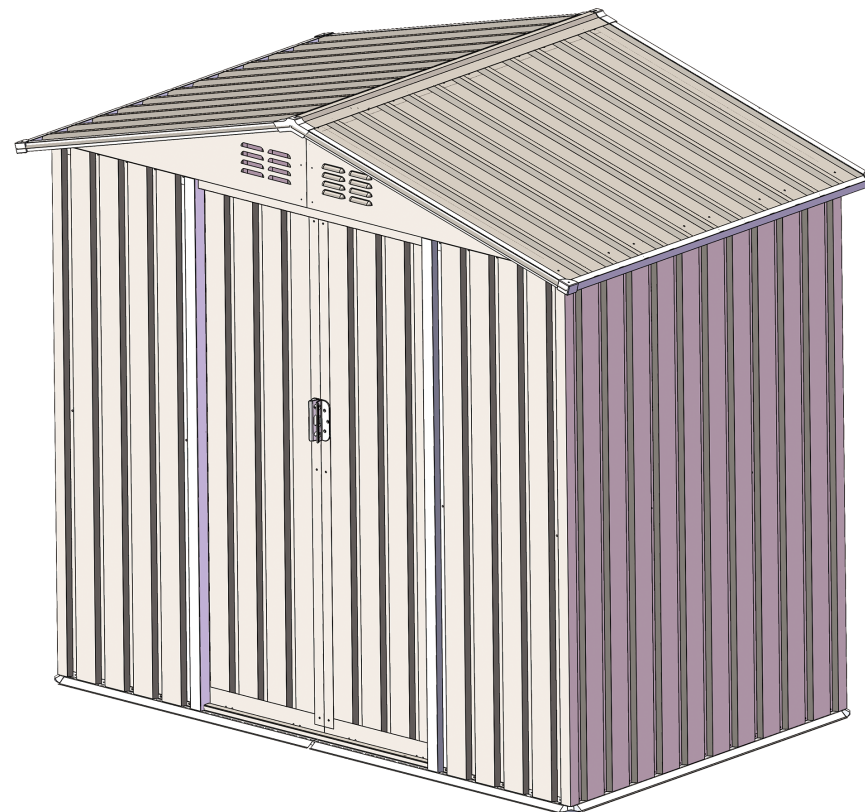
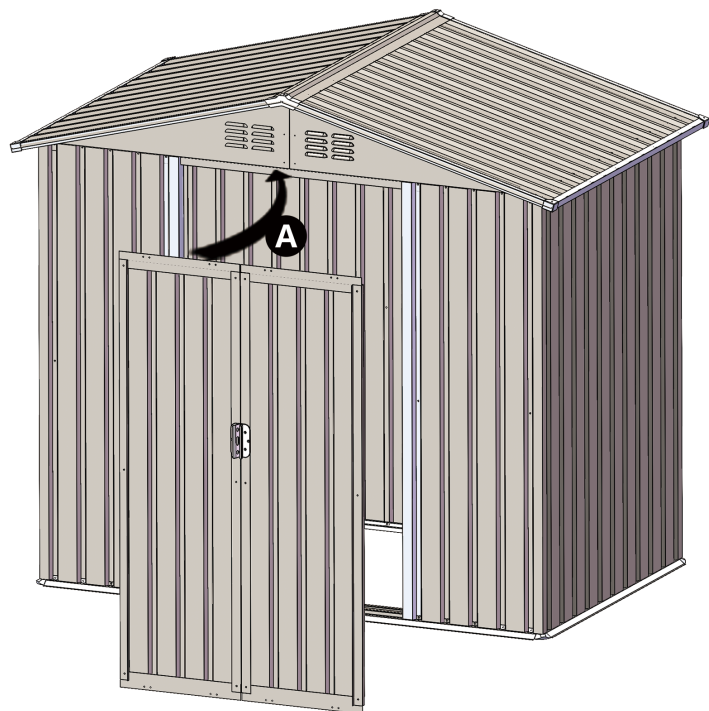

Notice:

Use F1 to secure the installed door to the pulley

The adjustment of the door can be achieved by the three holes of the pulley being at different heights

