

Installation & Assembly

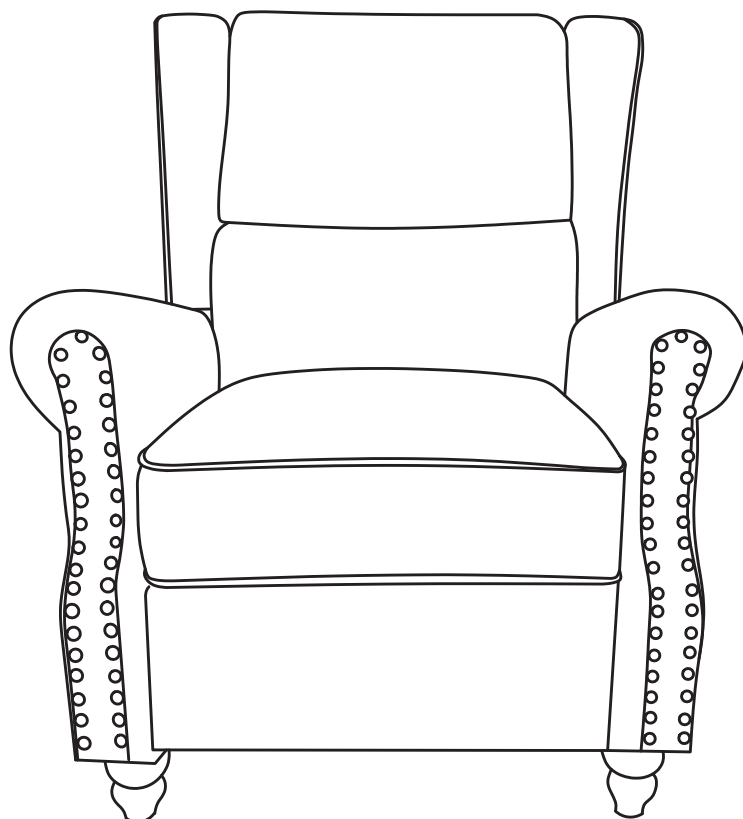
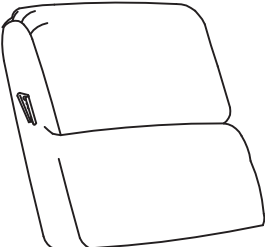
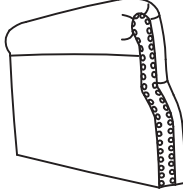
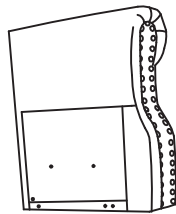
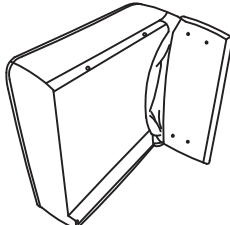
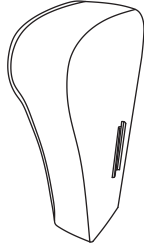
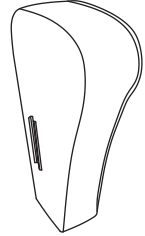
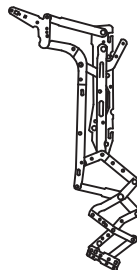
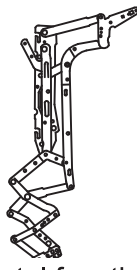
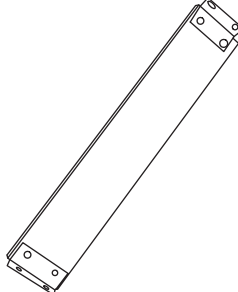
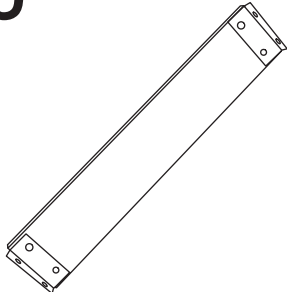
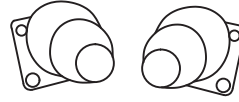
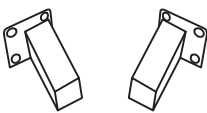
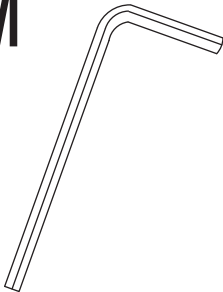
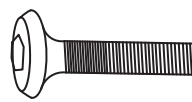
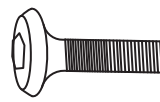
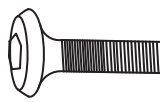

<p>A</p>  <p>backrest</p>	<p>B</p>  <p>armrest-left</p>	<p>C</p>  <p>armrest-right</p>	<p>D</p>  <p>seat and front panel</p>	
1PC	1PC	1PC	1PC	
<p>E</p>  <p>side ears of backrest-left</p>	<p>F</p>  <p>side ears of backrest-right</p>	<p>G</p>  <p>Sofa metal functional support-left</p>	<p>H</p>  <p>Sofa metal functional support-right</p>	
1PC	1PC	1PC	1PC	
<p>I</p>  <p>Connecting part-Front (For assemble left and right side arms)</p>	<p>J</p>  <p>Connecting part-Back(For assemble left and right side arms)</p>	<p>K</p>  <p>wood leg-front</p>	<p>L</p>  <p>wood leg-back</p>	
1PC	1PC	2PCS	2PCS	
<p>M</p>  <p>hex key</p>	<p>N</p>  <p>Bolt 45mm</p>	<p>P</p>  <p>Bolt 25mm</p>	<p>Q</p>  <p>Bolt 16mm</p>	
1PC	8PCS	12PCS	12PCS	

1

As picture shows, using Bolt P, Washer R and Connecting part-Front/Back, to assemble left and right side arms.

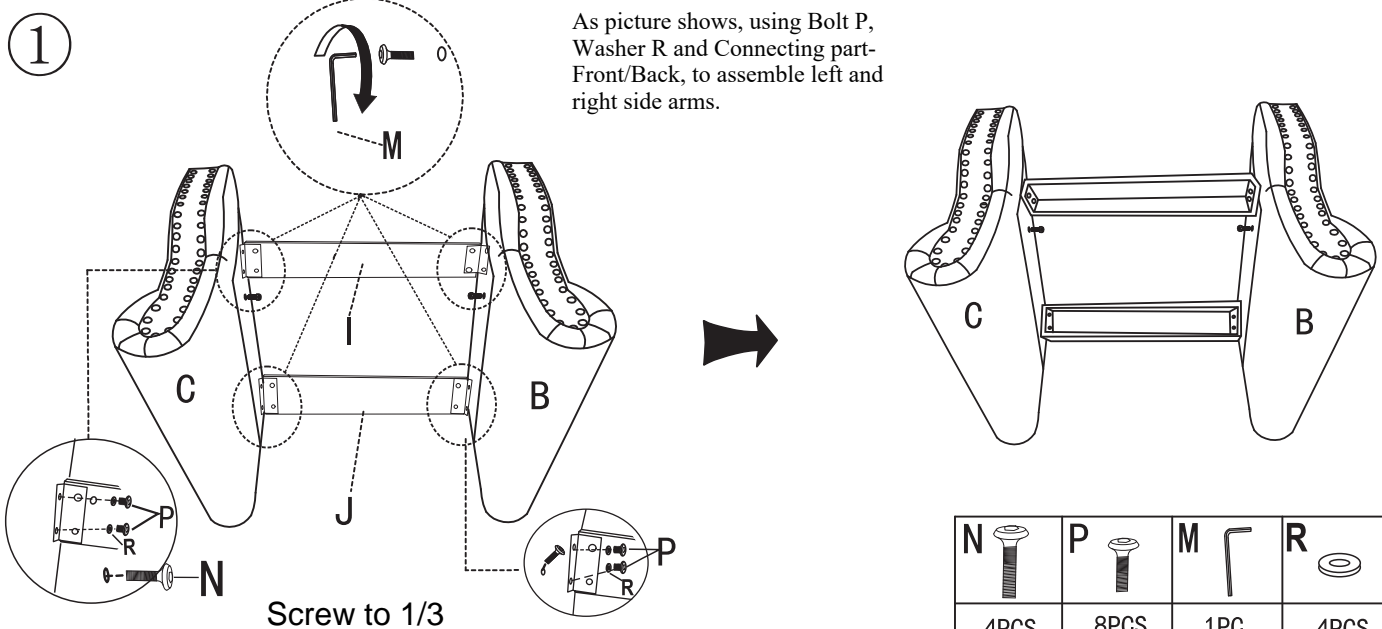

Screw to 1/3

N	P	M	R
4PCS	8PCS	1PC	4PCS

2

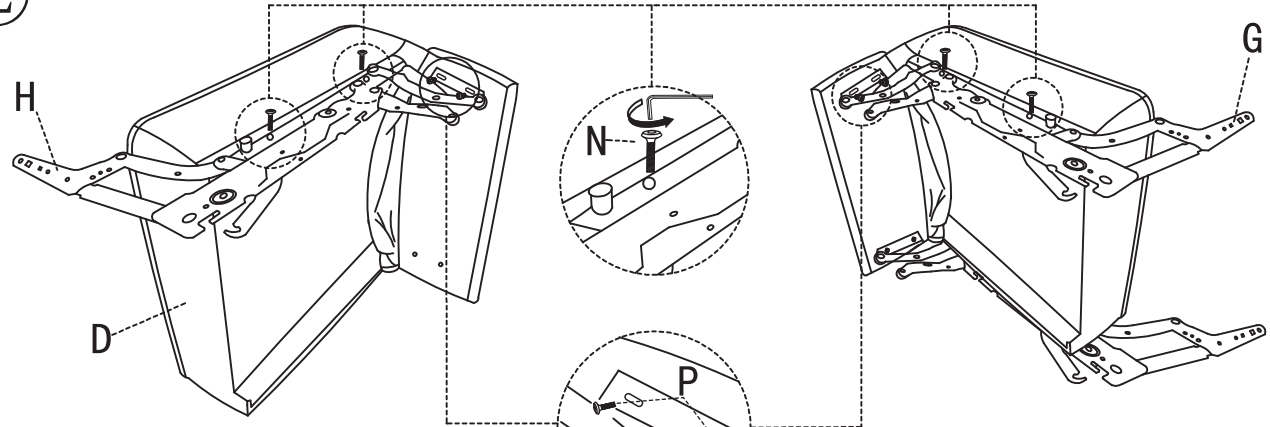

As picture shows, put the seat pad stand sideways, using Bolt N to assemble the metal frame on both left and right side of the seat pad. Aligns the holes on metal frame and footrest frame panel, using Bolt P to assemble.

The Bolt N/P have been already pre-assembled on correct position

N	P	M
4PCS	4PCS	1PC

3

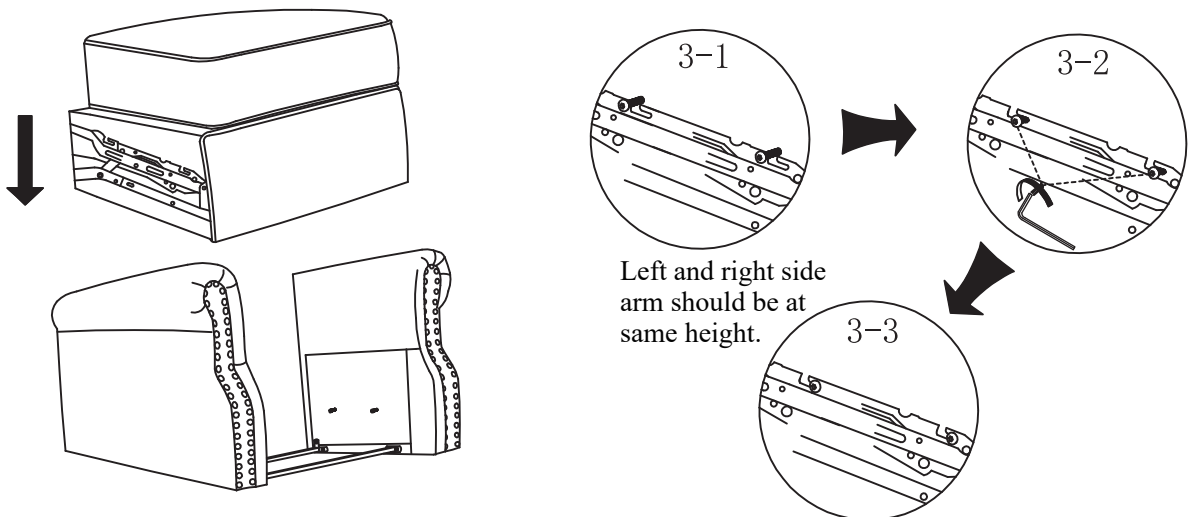

Left and right side arm should be at same height.

Using Bolt N, at the position as pictures shows, to assemble seat pad onto both left and right side arms. Make sure assemble at the same positions on metal frame.

4

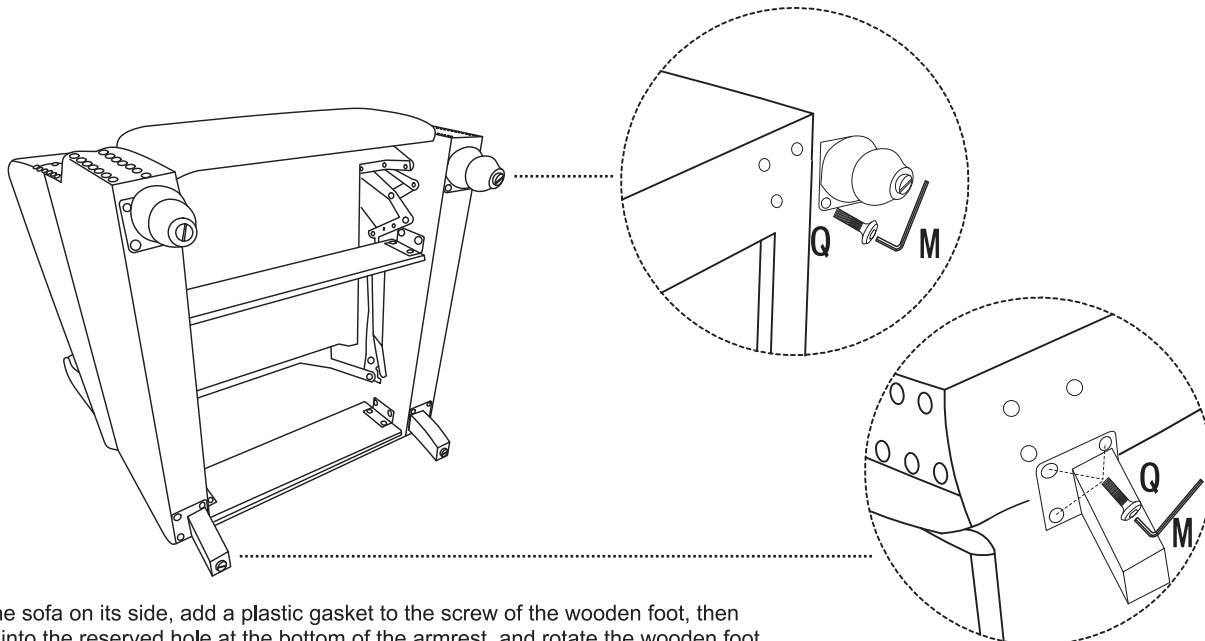

Place the sofa on its side, add a plastic gasket to the screw of the wooden foot, then insert it into the reserved hole at the bottom of the armrest, and rotate the wooden foot until it is tightest. Keep your back foot at the right Angle

5

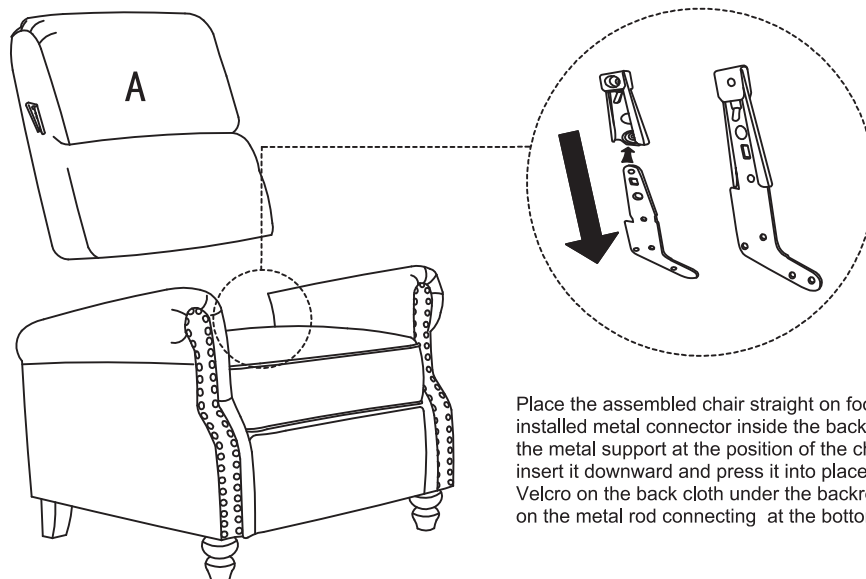

Place the assembled chair straight on foot. Align the pre-installed metal connector inside the backrest with the tip of the metal support at the position of the chair backrest, insert it downward and press it into place. Then attach the Velcro on the back cloth under the backrest to the Velcro on the metal rod connecting at the bottom of the chair

6

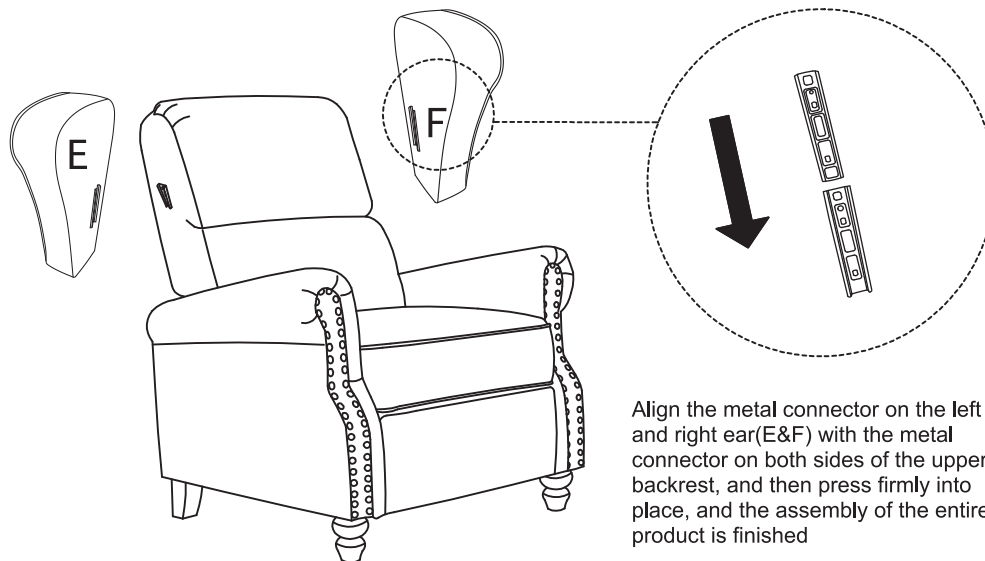

Align the metal connector on the left and right ear(E&F) with the metal connector on both sides of the upper backrest, and then press firmly into place, and the assembly of the entire product is finished