

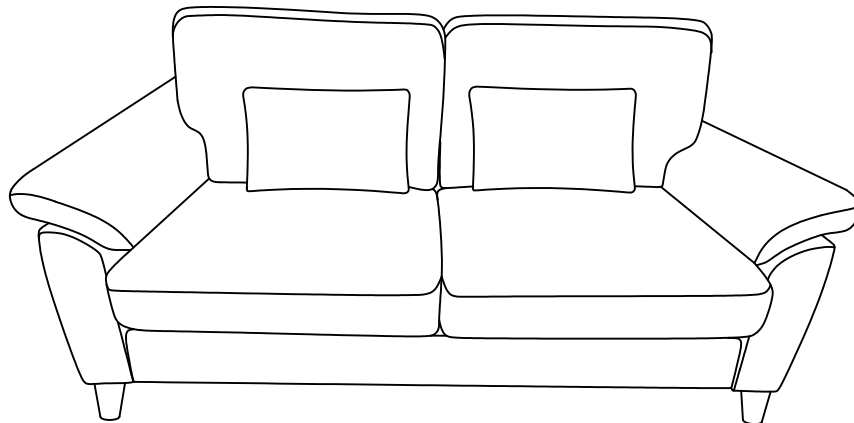

USER MANUAL



Warning Tips:

1. Review the installation instructions and check that all installation parts are complete.
2. Identify the parts (armrests) that need to be differentiated between left and right.
3. Tap the backrest and place it in the sunlight to fluff it up quickly, it takes about 48 hours for the backrest to fluff up.
4. Do not stand or jump on the parts of the sofa to avoid damage.
5. To ensure that the sofa does not get dirty, please make sure that the floor is clean enough before the installation begins.

Before you start...

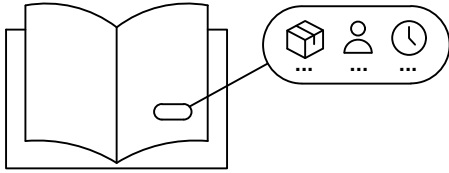

Ensure you have received all cartons and familiarize yourself with the workload. Make sure if you need someone to assist you, and that you have allocated the time required to assemble your new product.

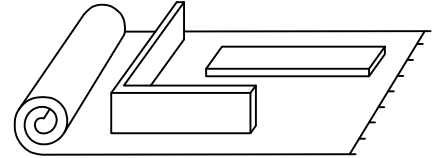

Please ensure that you leave enough space in your home for assembly. We recommend that you place cushions or cardboard on the floor to protect the floor and to ensure that the sofa does not get stained.

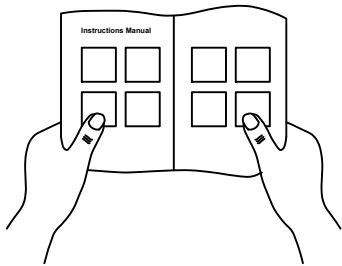

Read instructions carefully and check no parts are missing.

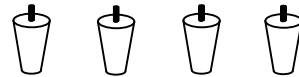

Lay out all hardware on a soft surface so you can easily identify them.

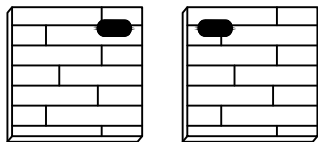

LEFT

RIGHT

Carefully identify all components in order to differentiate which pieces are left and right.

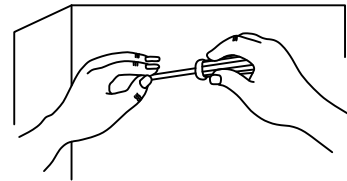

Install your new product carefully following the instructions. Don't skip ahead!

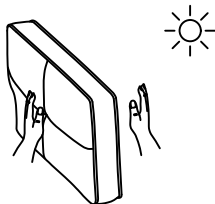

Tap the backrest and place it in the sunlight to fluff it up quickly, it takes about 48 hours for the backrest to fluff up.

Pay attention: Because of the compressed packaging, there may be some creases on the cover. Please do not worry, pat it several times and wait for moments, the crease will be more natural and will not affect the use.



Do not stand or jump on the parts of the sofa to avoid damage.

Product Diagram

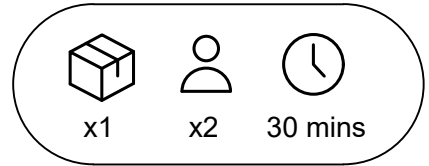

Parts

- A. Pedestal
- B. Cushion (seat)
- C. Backrest
- D. Cushion (back)
- E. Arm bag (left)
- F. Arm bag (right)
- G. Armrest (left)
- H. Armrest (right)
- I. Pillows
- J. Sofa legs

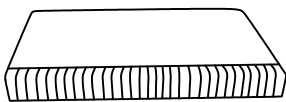
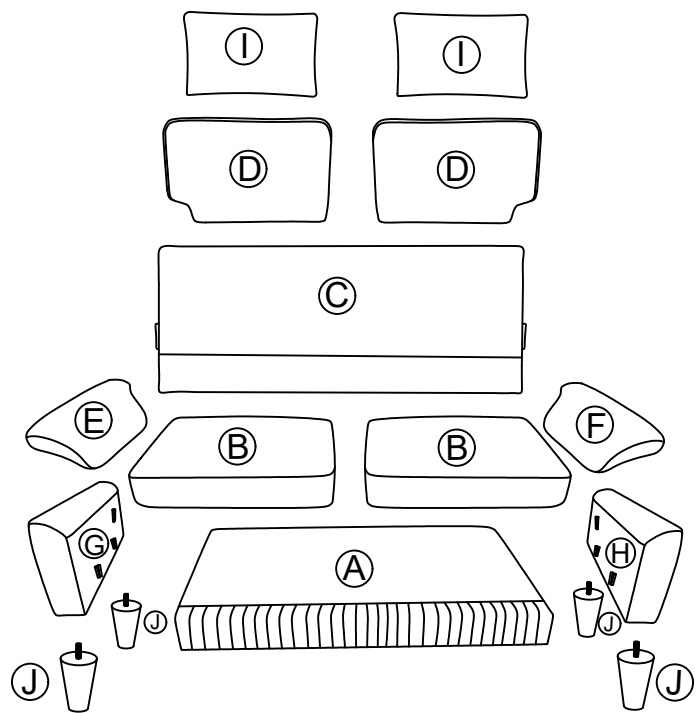

A*1



B*2

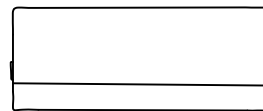

C*1

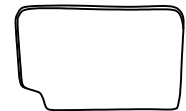

D*2



E*1



F*1

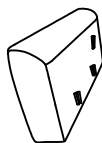

G*1



H*1



I*2



J*4

Installation Steps

STEP 1:

Install the pedestal to the left and right armrests.

Note: Place the orbit on the pedestal to the connector on the armrests, and you can slide from top to decline.

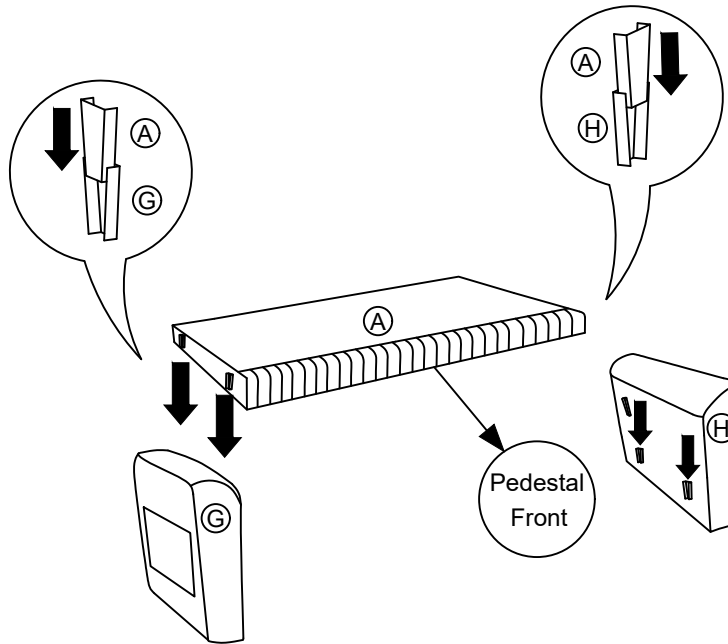

STEP 2:

Install the sofa legs to the pedestal.

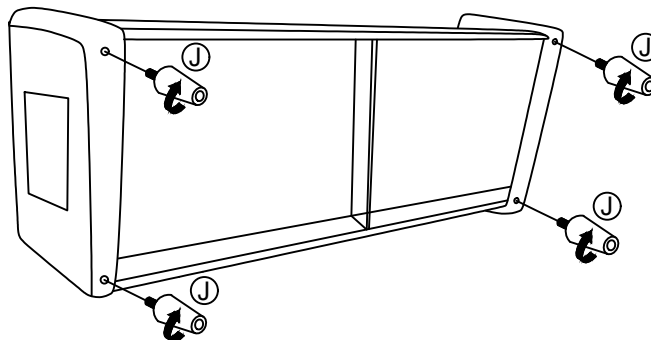

STEP 3:

Install the backrest (C) to the armrests.

Note: Place the orbit on the backrest to the connector on the armrests, and you can slide from top to decline.

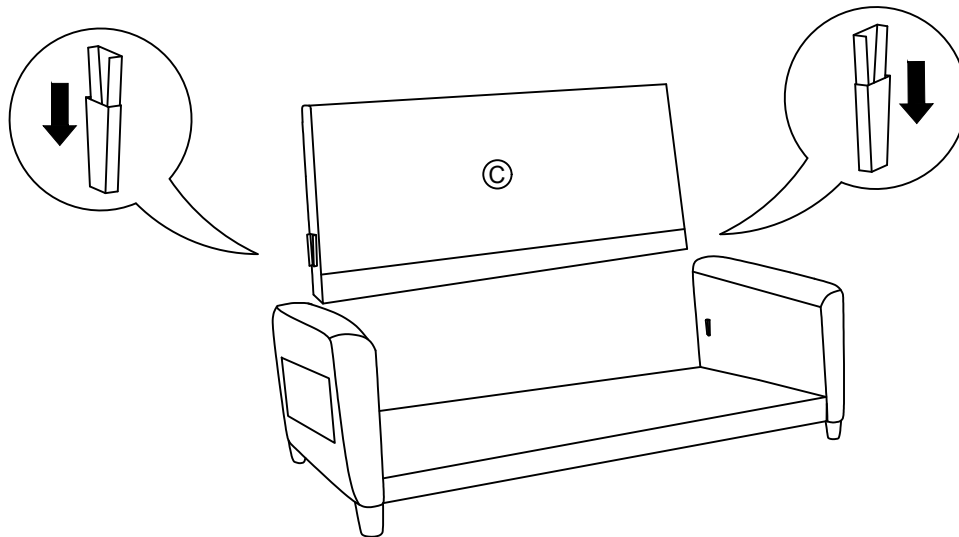

STEP 4:

Install the armrest bag (E&F) to the armrest frame.

- a. Please zip up armrest bag and armrest frame.
- b. Please kindly remove the cover tape from the velcro before putting together.

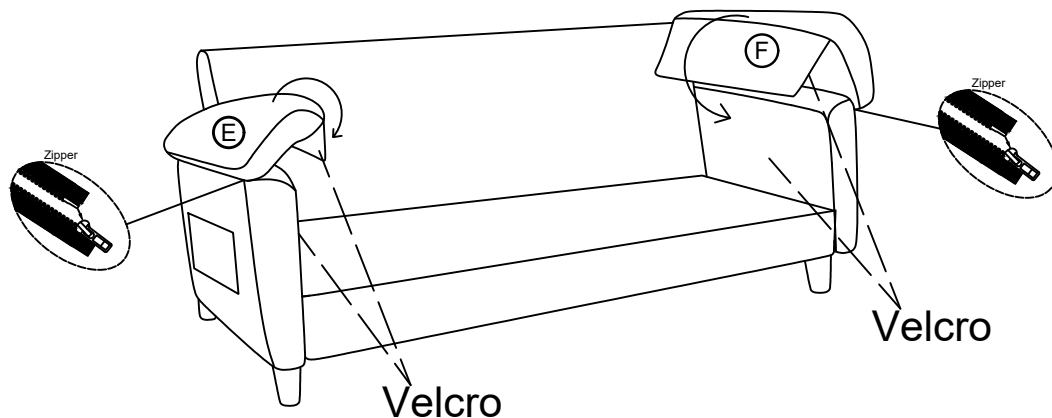

STEP 5:

Put the cushion (B) on the pedestal.

Note: Please remove the cover tape from the velcro before placing the cushion.

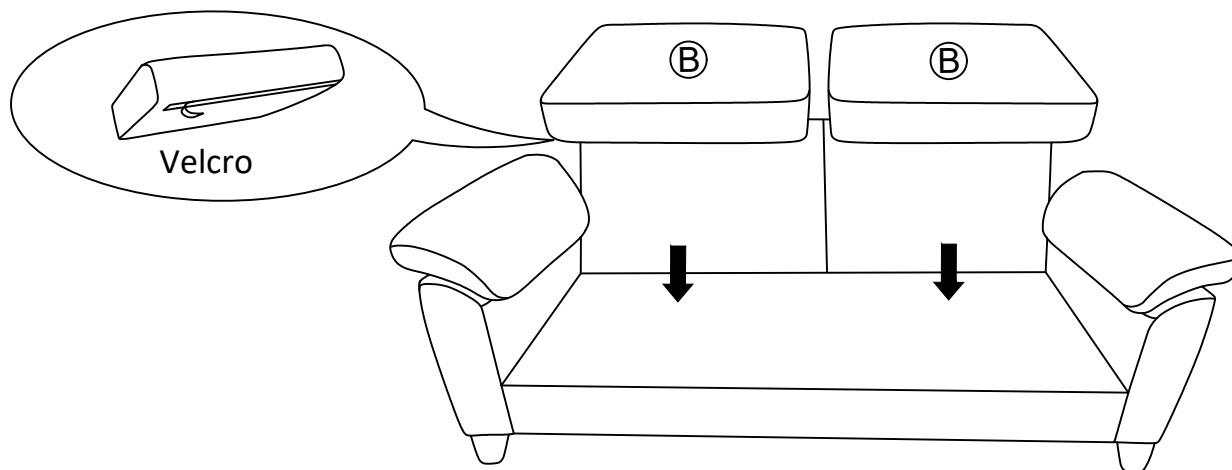

STEP 6:

Place the fluffy cushion (D) on the pedestal.

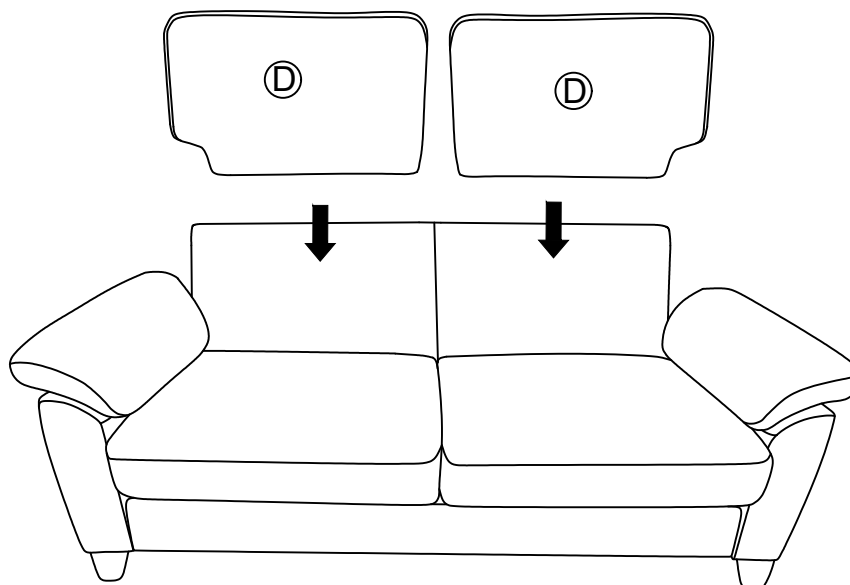

STEP 7:

Place the pillows on the sofa and decoration your sofa.

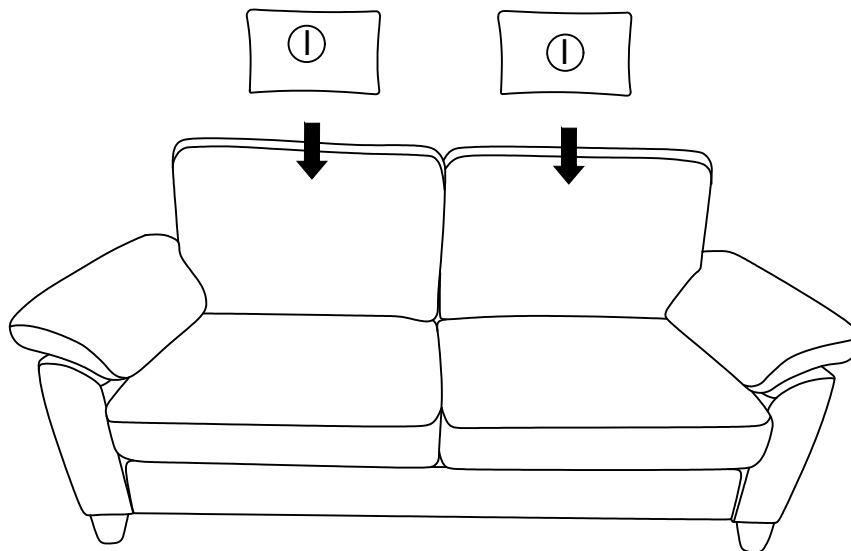

STEP 8:

Your sofa may require dressing on delivery.

Before using, please reshape the cushions to restore to its original beauty.

Note: Because of the compressed package, it will need take 48 hours to completely recovery.

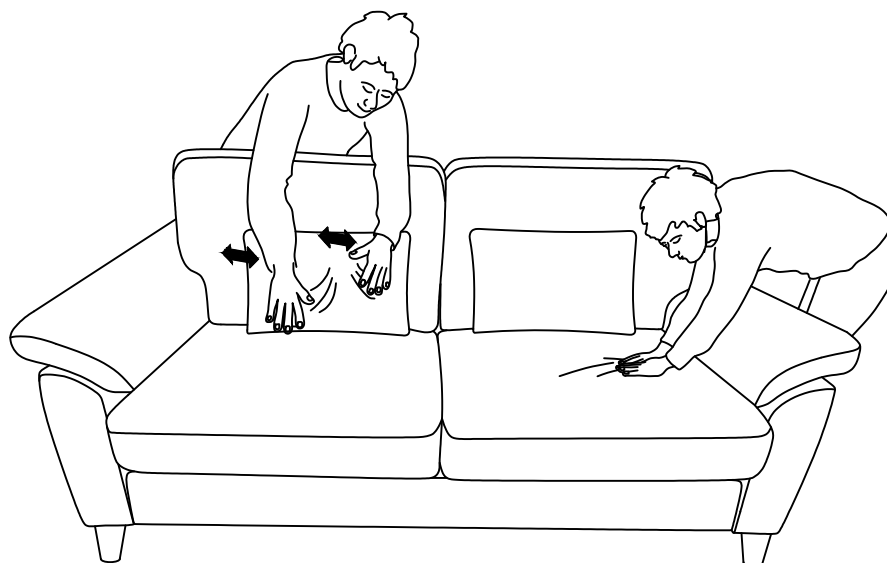

STEP 9:

The sofa has been installed, and you can start enjoying your leisure time.

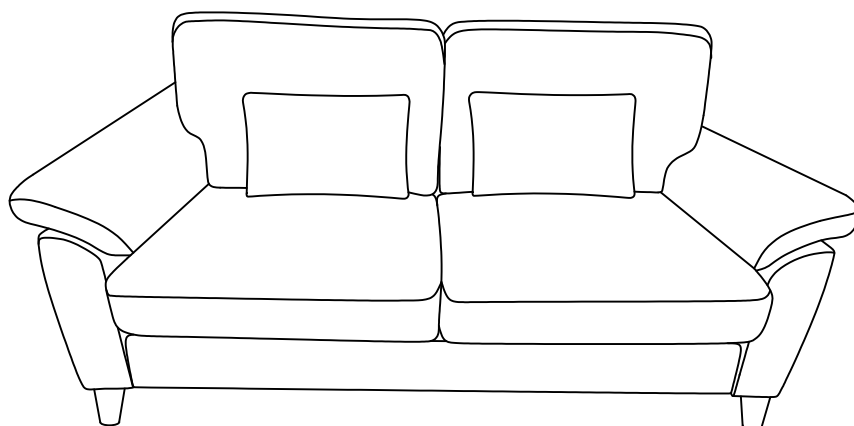

If you need any further assistance with our amazing sofa (especially when it comes to installation), please don't hesitate to contact us via email at:
customerservice@aaqzhk.com

We're always here to help!
Thank you so much for choosing us, and have a fantastic day!^-^