



ASME A112.18.1 / CSA B125.1

# INSTALLATION INSTRUCTIONS



- **Model 2022**
- **Concord Series**
- **3 Hole Installation**

**For easy installation of your faucet please:**

- **READ ALL** the instructions, warnings, care and maintenance information before beginning
- Purchase the correct water supply hook-up

You may need:

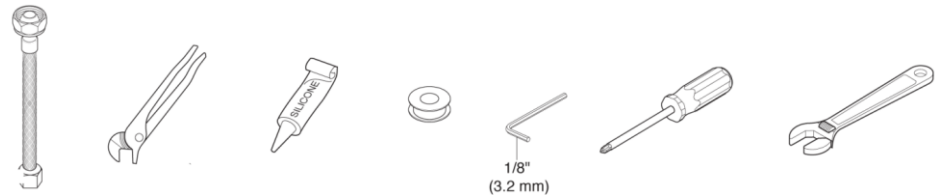

## 1. Before Proceeding

We recommend calling a professional if you are uncertain about installing this product! This product should be installed in accordance with all local and state plumbing and building code requirements.

## 2. Shut Off Water Supplies

Locate the water supply inlets and shut off both the hot and cold water supply valves. If you are replacing an existing faucet, remove the old faucet. Clean the sink surface thoroughly in preparation for the new faucet.

## 3. Secure New Faucet

Position the faucet on the sink. If the sink surface is uneven, a small amount of silicone sealant may be needed. Secure locknuts on the shank and hand tighten.

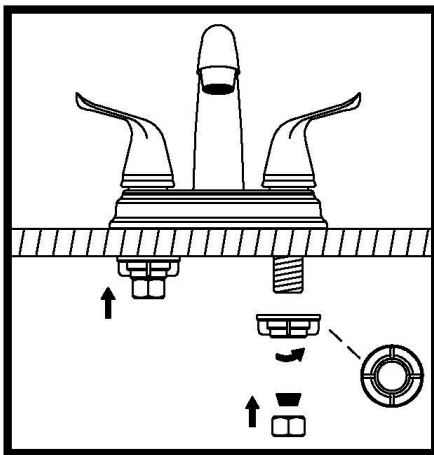

## 4. Connect to Water Supplies (Hook-Ups Not Provided). Flush System/Check for Leaks

Connect the hot and cold water supplies to the shanks as shown. Remove the aerator. Turn the handle all the way on. Turn on hot and cold water supplies and flush water lines for one minute. This flushes away any debris that could cause damage to internal parts. Check all connections for leaks. Replace aerator. Re-tighten if necessary, but do not over tighten.

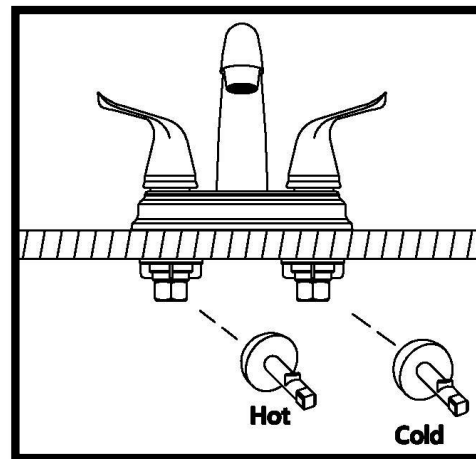

## Pop-Up Drain Installation

### 1. Preparation

Unscrew the top portion off the drain body and apply plumbers' tape on the top threaded end of the drain body.

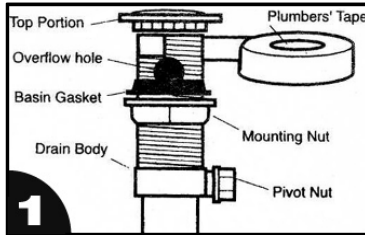

### 2. Secure Pop-Up to the Sink

Insert the drain body from under the sink and screw the top portion onto the drain body. A small amount of silicone might be needed if the sink surface is uneven to seal top portion to sink. Tighten the mounting nut with a wrench, but do not over tighten.

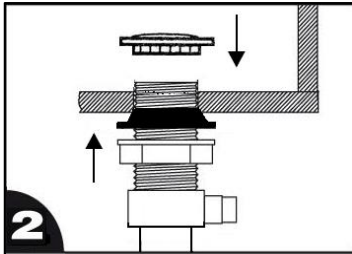

### 3. Install the Pivot Rod

Insert the pivot rod into drain body and through the hole at the end of plunger. Tighten the pivot nut by hand.

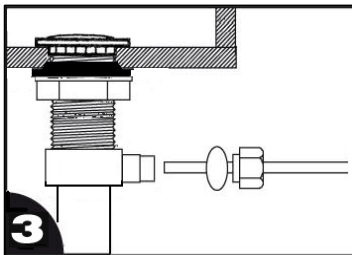

### 4. Attach the Linker

Attach the linker to the end of the pivot rod as shown.

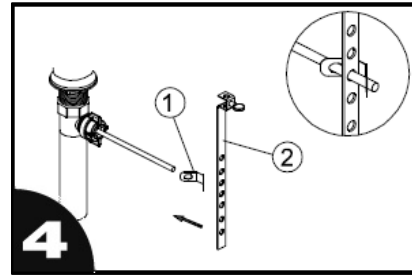

### 5. Install the Lift Rod

Insert the lift rod from the lift rod hole in the faucet and through both holes in the linker. Adjust the linker position on the pivot rod and the lift rod length that goes into the linker before locking the lift rod onto the linker by tightening down the screw on linker.

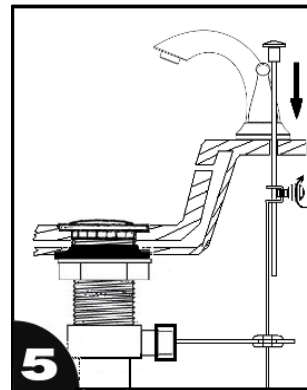

# CLEANING AND CARE

---

Care should be given to the cleaning of this product. Although the finish is extremely durable, it can be damaged by harsh abrasives or polish. To clean, simply wipe gently with a damp cloth and blot dry with a soft towel.

**WARNING: SCRUBBING BUBBLES® BATHROOM CLEANER, LYSOL® BASIN TUB AND TILE CLEANER, and all other chemical cleaners must not be used on the faucet body and handle.** Use of these cleaners can crack and/or severely damage the faucet. If overspray of these cleaners gets onto the faucet, immediately dry with a soft cotton cloth.

# MAINTENANCE

---

## If faucet exhibits very low flow

- Remove and clean aerator

## If faucet leaks under the sink

- Inspect all supply line connections, tighten where necessary

## If faucet leaks from under handle

- Remove handle. Ensure bonnet nut is tight. Clean or replace the o-ring

- **WARNING: Failure to securely tighten bonnet nut could result in water damage**

# LIMITED LIFETIME WARRANTY

---

Foremost Import LLC warrants to the original purchaser that its products will be free from defects in workmanship and materials. We recommend using a professional plumber for all installation and repairs. This warranty DOES NOT COVER LABOR CHARGES AND/OR DAMAGE INCURRED IN INSTALLATION, REPAIR, OR REPLACEMENT AS WELL AS ANY OTHER KIND OF LOSS OR DAMAGES. Any damage to this faucet as a result of misuse, abuse, or neglect, WILL VOID THE WARRANTY. This warranty applies only for faucets installed in the United States of America.

Replacement parts may be obtained by writing to [customerservice@foremostimport.com](mailto:customerservice@foremostimport.com)

Proof of purchase from the original purchaser must be made available to Foremost Import LLC for all warranty claims. This exclusive written warranty is not transferable.